

SERVOCOMANDO SERRANDA ARIA
AIR DAMPER ACTUATOR
STA4.5B.. (AB) / STA13B.. (PR)

I ALTA FIAMMA
HIGH FLAME
II SOSTA
STAND-BY
IV BASSA FIAMMA
LOW FLAME
III NON USATA
NOT USED

SERVOCOMANDO SERRANDA ARIA
AIR DAMPER ACTUATOR
SQN72.2xx (AB) / SQN72.4xx (PR)

I (ROSSO)
I (RED) ALTA FIAMMA
HIGH FLAME
II (BLU)
II (BLUE) SOSTA
STAND-BY
III (ARANCIO)
III (ORANGE) BASSA FIAMMA
LOW FLAME
IV (NERO)
IV (BLACK) NON USATA
NOT USED

CIRCUITO STAMPATO
PRINTED CIRCUIT BOARD
COD. 6100545

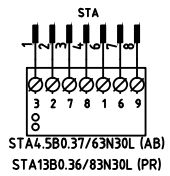
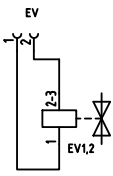
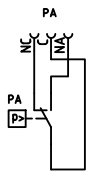
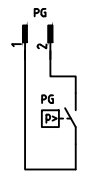
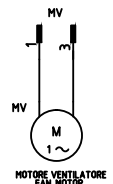

STA4.5B0.37/63N30L (AB)
STA13B0.36/83N30L (PR)

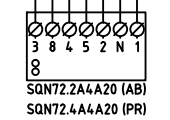

SQN72.2A4A20 (AB)
SQN72.4A4A20 (PR)

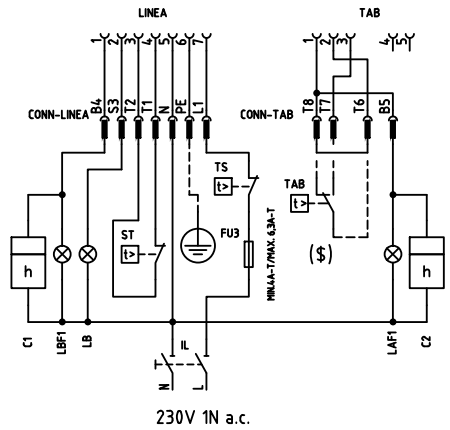

230V 1N a.c.

(xxx) SOLO CON ALIMENTAZIONE ELETTRICA SENZA NEUTRO
WITH ELECTRIC SUPPLY WITHOUT NEUTRAL VERSION ONLY

(\$) SE USATO "TAB", TOGLIERE IL PONTE TRA I MORSETTI T6-T8
IF USED "TAB", REMOVE THE BRIDGE BETWEEN TERMINALS T6-T8

03	ADDED "PR" VERSION	13/09/12	U. PINTON
02	AGGIUNTO/ADDED SQN72.xx	22/05/09	U. PINTON
01	AGGIUNTO/ADDED LME22	27/03/06	U. PINTON
REV.	MODIFICA	DATA	FIRME



Impianto
TIPI/TYPES NG/NGX/LG 70 - 90
MODELLO/MODEL x-.AB(PR).x.xx.A.x.xx

Descrizione
VERSIONE CON CIRCUITO STAMPATO
WITH PRINTED CIRCUIT VERSION

Ordine		Data	18/10/2005	PREC.	FOGLIO
Commissa		Data Controllato	13/09/2012	/	1
Esecutore	U. PINTON	Controllato	S. MARCHETTI	Dis. N.	18 - 070
				SEGUE	TOTALE
				2	2

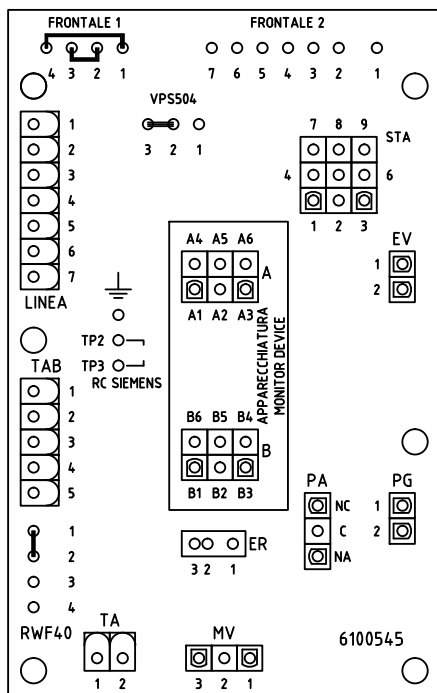

SIGLA/ITEM	FUNZIONE	FUNCTION
C1	CONTAORE BASSA FIAMMA	LOW FLAME TIME COUNTER
C2	CONTAORE ALTA FIAMMA	HIGH FLAME TIME COUNTER
ER	ELETTRODO RILEVAZIONE FIAMMA	FLAME DETECTION ELECTRODE
EV1,2	ELETTROVALVOLE GAS (O GRUPPO VALVOLE)	GAS ELECTRO-VALVES (OR VALVES GROUP)
FU3	FUSIBILE LINEA BRUCIATORE	BURNER LINE FUSE
IL	INTERRUTTORE LINEA BRUCIATORE	BURNER LINE SWITCH
LAF1	LAMPADA SEGNALE ALTA FIAMMA BRUCIATORE	BURNER IN HIGH FLAME INDICATOR LIGHT
LB	LAMPADA SEGNALE BLOCCO BRUCIATORE	INDICATOR LIGHT FOR BURNER LOCK-OUT
LBF1	LAMPADA SEGNALE BASSA FIAMMA BRUCIATORE	BURNER IN LOW FLAME INDICATOR LIGHT
MV	MOTORE VENTILATORE	FAN MOTOR
PA	PRESSOSTATO ARIA COMBURENTE	COMBUSTION AIR PRESSURE SWITCH
PG	PRESSOSTATO GAS DI MINIMA PRESSIONE	MINIMUM GAS PRESSURE SWITCH
RC	CIRCUITO RC	RC CIRCUIT
SATRONIC DMG 972	APPARECCHIATURA CONTROLLO FIAMMA	CONTROL BOX
SIEMENS (602.33/1M62.33/1M62.33)	APPARECCHIATURA CONTROLLO FIAMMA	CONTROL BOX
SQN72.2A4.A20 (AB)	SERVOCOMANDO SERRANDA ARIA (ALTERNATIVO)	AIR DAMPER ACTUATOR (ALTERNATIVE)
SQN72.4A4.A20 (PR)	SERVOCOMANDO SERRANDA ARIA (ALTERNATIVO)	AIR DAMPER ACTUATOR (ALTERNATIVE)
ST	SERIE TERMOSTATI/PRESSOSTATI	SERIES OF THERMOSTATS OR PRESSURE SWITCHES
STA4.580.37/63N30L (AB)	SERVOCOMANDO SERRANDA ARIA	AIR DAMPER ACTUATOR
STA1380.36/83N30L (PR)	SERVOCOMANDO SERRANDA ARIA	AIR DAMPER ACTUATOR
TA	TRASFORMATORE DI ACCENSIONE	IGNITION TRANSFORMER
TAB	TERMOSTATO/PRESSOSTATO ALTA-BASSA FIAMMA	HIGH-LOW THERMOSTAT/PRESSURE SWITCHES
TS	TERMOSTATO/PRESSOSTATO DI SICUREZZA	SAFETY THERMOSTAT OR PRESSURE SWITCH
VPS50x	CONTROLLO DI TENUTA VALVOLE GAS (OPZIONALE)	GAS PROVING SYSTEM (OPTIONAL)

Data	18/10/2005	PREC.	FOGLIO
Revisione	03	1	2
Dis. N.	18 - 070	SEGUE	TOTALE
		/	2