

VERSIONE MONOSTADIO "TN"
"TN" SINGLE-STAGE VERSION

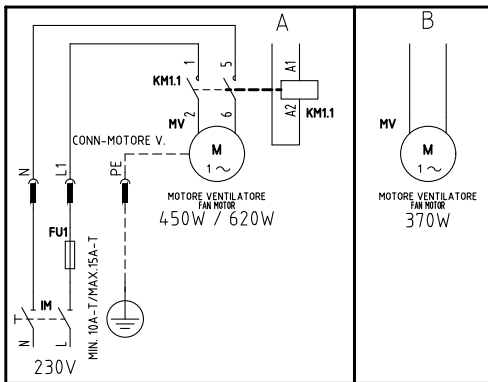

(#) MOTORE VENTIL. 450W O 620W, FU2 = 6,3A F; MOTORE VENTIL. 370W, FU2 = 10A F
FAN MOTOR 450W OR 620W, FU2 = 6,3A F; FAN MOTOR 370W FU2 = 10A F

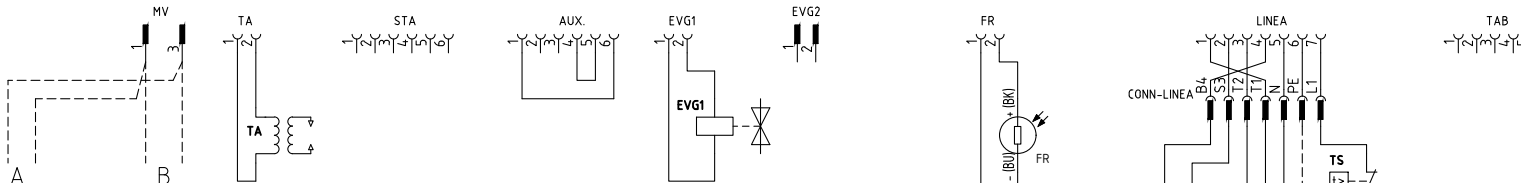
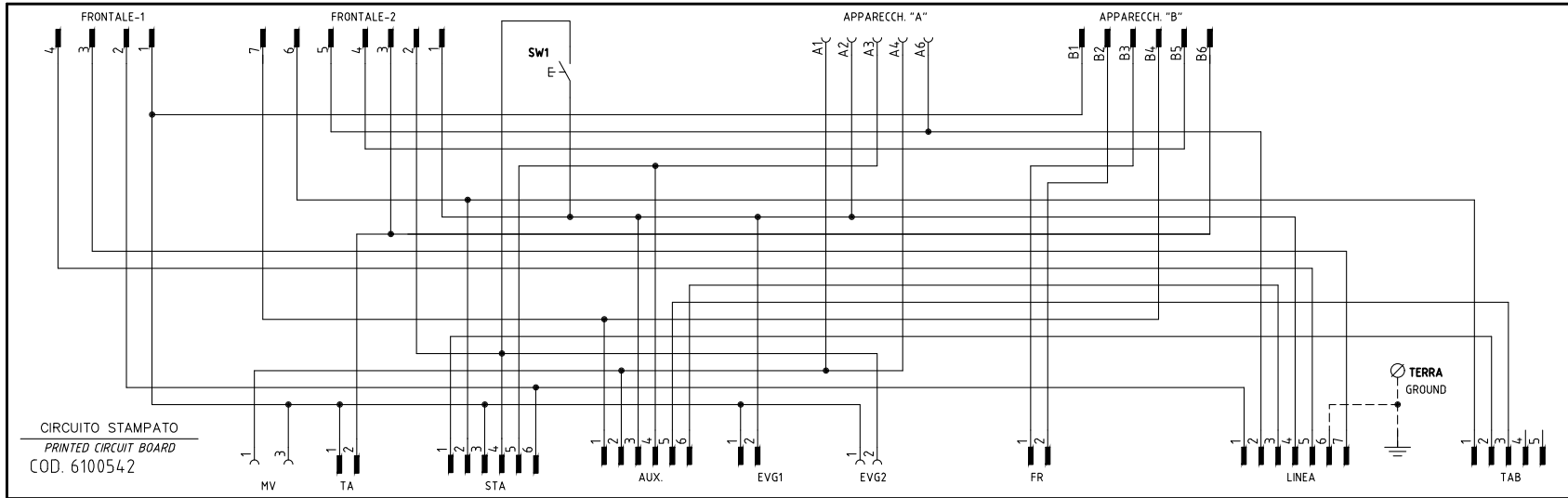
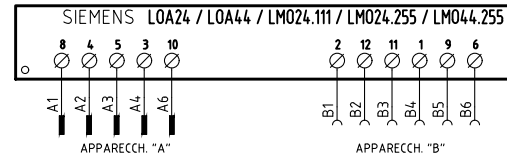
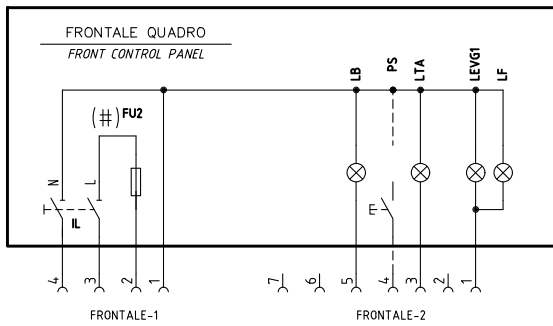

Impianto
TIPI/TYPES LO400 - LO550
MODELLO/MODEL G-.TN(AB). x.xx.A.x
Descrizione

Ordine
Commissa
Esecutore
U. PINTON

Data Contrallato
07/01/2013

Controllato
S. MARCHETTI

Data 13/10/2004
Revisione **04**
Dis. N. **18 - 0049**

PREC. /
FOGLIO 1
SEQUE 2
TOTALE 3

REV.	MODIFICA	DATA	FIRME
04	AGGIUNTO/ADDED LMO24-255	07/01/13	U. PINTON
03	AGGIUNTO/ADDED "SQN72..."	22/05/09	U. PINTON
02	CORRETTO/CORRECT "CONN. EVG2"	04/04/08	U. PINTON
01	AGGIUNTO/ADDED LO550	19/09/07	U. PINTON

VERSIONE ALTA-BASSA FIAMMA "AB"
"AB" HIGH/LOW FLAME VERSION

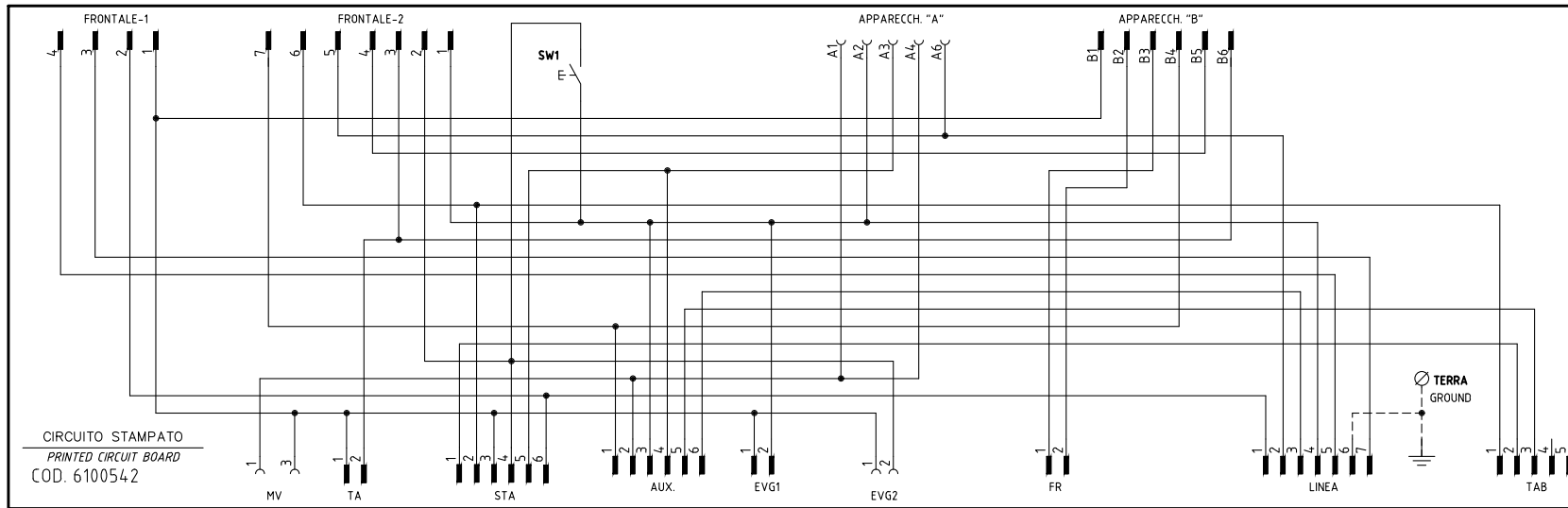
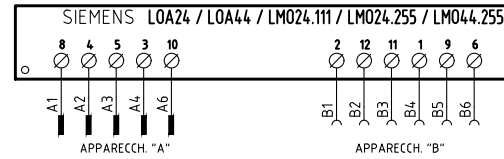
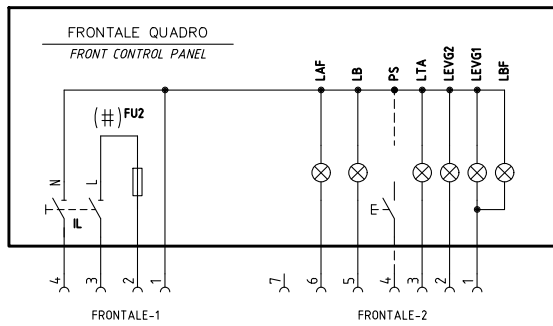

SERVOCOMANDO SERRANDA ARIA
AIR DAMPER ACTUATOR
STA4.5B0.37/63N30L

- I ALTA FIAMMA
HIGH FLAME
- II SOSTA ACCENSIONE, BASSA FIAMMA
STAND-BY, IGNITION, LOW FLAME
- III APERTURA EVG2
OPEN EVG2

SERVOCOMANDO SERRANDA ARIA (ALTERNATIVO)
AIR DAMPER ACTUATOR (ALTERNATIVE)
SQN72.2A4A20

- I (ROSSO) ALTA FIAMMA
I (RED) HIGH FLAME
- II (BLU) SOSTA ACCENSIONE, BASSA FIAMMA
II (BLUE) STAND-BY, IGNITION, LOW FLAME
- IV (NERO) APERTURA EVG2
IV (BLACK) OPEN EVG2

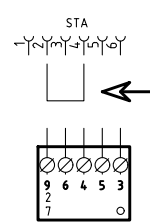
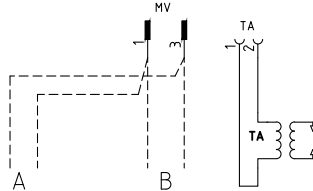

VERSIONE CON MARTINETTO IDRAULICO
WITH HYDRAULIC RAM VERSION

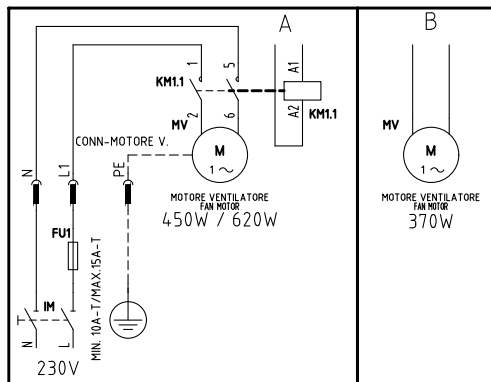
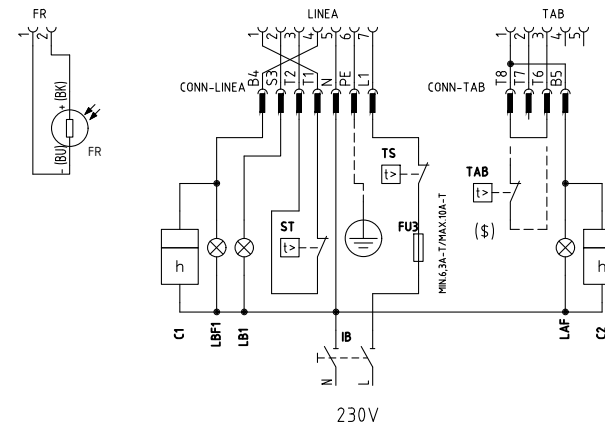
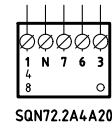

(#) MOTORE VENTIL. 450W O 620W, FU2 = 6,3A F; MOTORE VENTIL. 370W, FU2 = 10A F
FAN MOTOR 450W OR 620W, FU2 = 6,3A F; FAN MOTOR 370W FU2 = 10A F

(\$) SE PREVISTO "TAB", TOGLIERE IL PONTE TRA I MORSETTI T6-T8
IF "TAB" USED REMOVE THE BRIDGE BETWEEN TERMINALS T6-T8

Data	13/10/2004	PREC.	FOGLIO
Revisione	04	1	2
Dis. N.	18 - 0049	SEGUE	TOTALE
		3	3

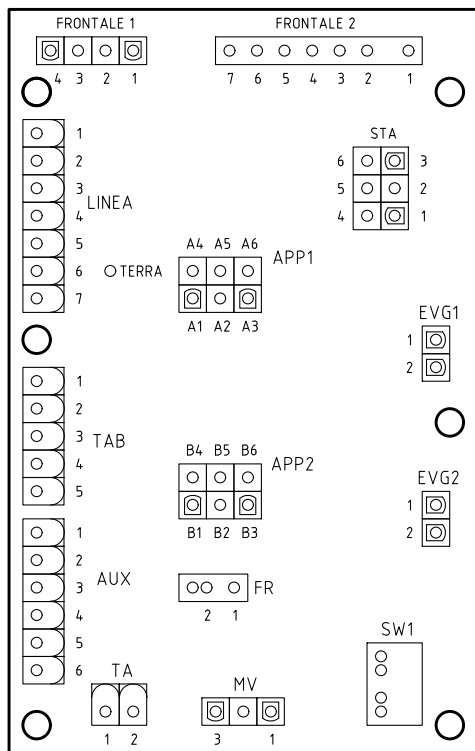

SIGLA/ITEM	Funzione	FUNCTION
C1	CONTAORE BASSA FIAMMA	LOW FLAME TIME COUNTER
C2	CONTAORE ALTA FIAMMA	HIGH FLAME TIME COUNTER
EVG1	ELETTROVALVOLA GASOLIO BASSA FIAMMA	LOW FLAME LIGHT OIL SOLENOID VALVE
EVG2	ELETTROVALVOLA GASOLIO ALTA FIAMMA	HIGH FLAME LIGHT OIL SOLENOID VALVE
FR	FOTORESISTENZA RILEVAZIONE FIAMMA	PHOTORESISTOR FLAME DETECTOR
FU1	FUSIBILE LINEA MOTORE VENTILATORE	FAN MOTOR LINE FUSE
FU2	FUSIBILE DI LINEA	LINE FUSE
FU3	FUSIBILE LINEA BRUCIATORE	BURNER LINE FUSE
IB	INTERRUTTORE LINEA BRUCIATORE	BURNER LINE SWITCH
IL	INTERRUTTORE LINEA AUSILIARI	AUXILIARY LINE SWITCH
IM	INTERRUTTORE LINEA MOTORE VENTILATORE	FAN MOTOR LINE SWITCH
KM1.1	CONTATTORE MOTORE VENTILATORE	FAN MOTOR CONTACTOR
LAF	LAMPADA SEGNALAZIONE ALTA FIAMMA BRUCIATORE	BURNER IN HIGH FLAME INDICATOR LIGHT
LB	LAMPADA SEGNALAZIONE BLOCCO BRUCIATORE	INDICATOR LIGHT FOR BURNER LOCK-OUT
LB1	LAMPADA SEGNALAZIONE BLOCCO BRUCIATORE	INDICATOR LIGHT FOR BURNER LOCK-OUT
LBF	LAMPADA SEGNALAZIONE BASSA FIAMMA BRUCIATORE	BURNER IN LOW FLAME INDICATOR LIGHT
LBF1	LAMPADA SEGNALAZIONE BASSA FIAMMA BRUCIATORE	BURNER IN LOW FLAME INDICATOR LIGHT
LEV1	LAMPADA SEGNALAZIONE APERTURA [EVG1]	INDICATOR LIGHT FOR OPENING OF ELECTRO-VALVE [EVG1]
LEV2	LAMPADA SEGNALAZIONE APERTURA [EVG2]	INDICATOR LIGHT FOR OPENING OF ELECTRO-VALVE [EVG2]
LF	LAMPADA SEGNALAZIONE FUNZIONAMENTO BRUCIATORE	INDICATOR LIGHT BURNER OPERATION
LOA.. / LMO..	APPARECCHIATURA CONTROLLO FIAMMA	CONTROL BOX
LTA	LAMPADA SEGNALAZIONE TRASFORMATORE DI ACCENSIONE	IGNITION TRANSFORMER INDICATOR LIGHT
MV	MOTORE VENTILATORE	FAN MOTOR
PS	PULSANTE SBLOCCO FIAMMA (SOLO CON LOA44 E LMO..)	LOCK-OUT RESET BUTTON (WITH LOA44 AND LMO.. ONLY)
SQ72.2A4A20	SERVOCOMANDO SERRANDA ARIA (ALTERNATIVO)	AIR DAMPER ACTUATOR (ALTERNATIVE)
ST	SERIE TERMOSTATI/PRESSOSTATI	SERIES OF THERMOSTATS OR PRESSURE SWITCHES
STA4.5B0.37/63N30L	SERVOCOMANDO SERRANDA ARIA	AIR DAMPER ACTUATOR
SW1	PULSANTE INNESCO SECONDO STADIO BRUCIATORE	II° STAGE BURNER START BUTTON
TA	TRASFORMATORE DI ACCENSIONE	IGNITION TRANSFORMER
TAB	TERMOSTATO/PRESSOSTATO ALTA-BASSA FIAMMA	HIGH-LOW THERMOSTAT/PRESSURE SWITCHES
TS	TERMOSTATO/PRESSOSTATO DI SICUREZZA	SAFETY THERMOSTAT OR PRESSURE SWITCH

Data	13/10/2004	PREC.	FOGLIO
Revisione	04	2	3
Dis. N.	18 - 0049	SEGUE	TOTALE
		/	3