

Data	23/11/2022	PREC.	FOGLIO
Revisione	00	4	5
Dis. N.	05 - 1399	SEGUE	TOTALE
		6	13

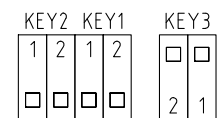
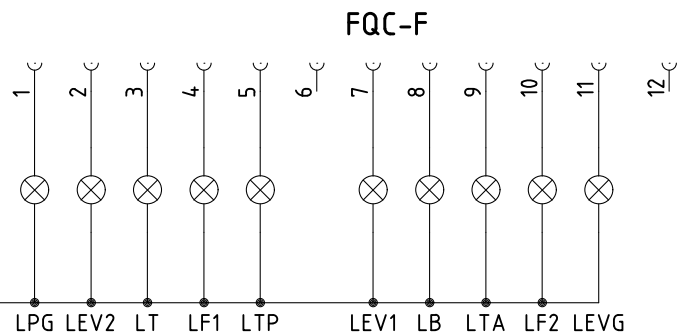
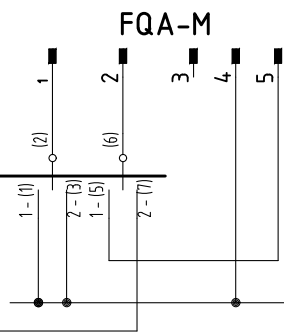
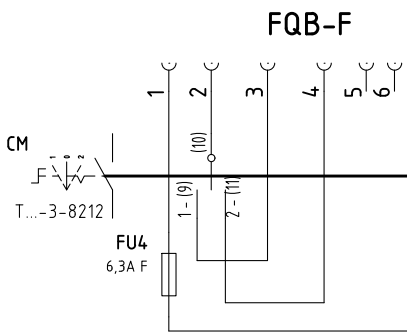
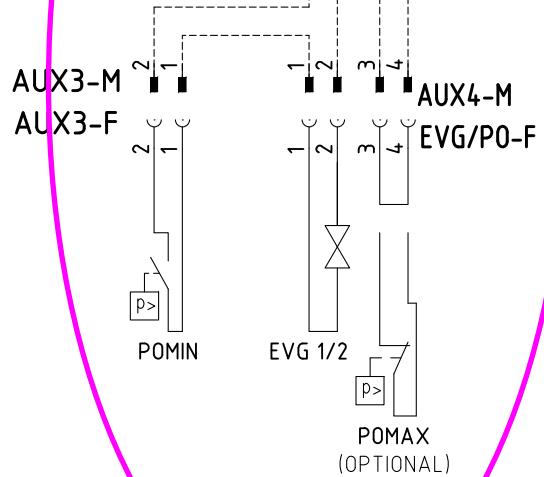
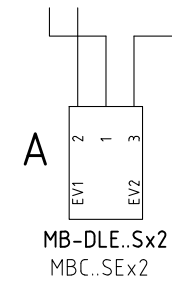
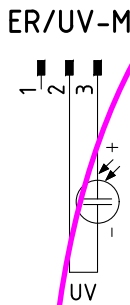
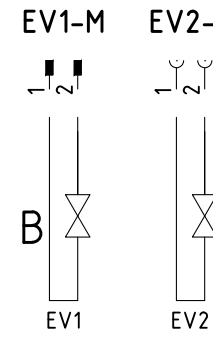
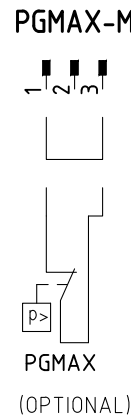
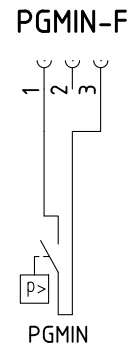
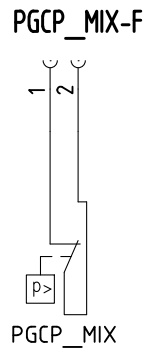
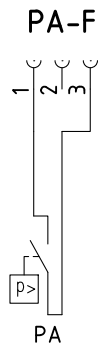
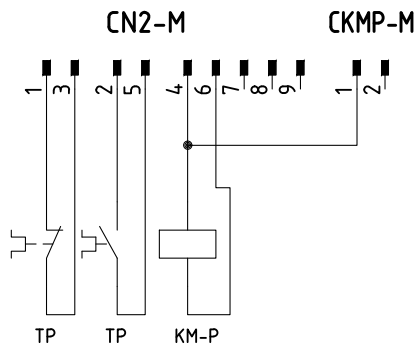
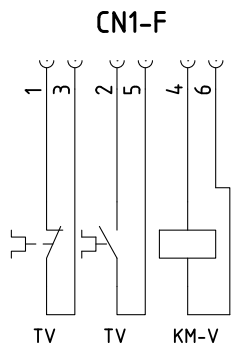

Data	23/11/2022	PREC.	FOGLIO
Revisione	00	9	10
Dis. N.	05 - 1399	SEGUE	TOTALE
		11	13