

VERSIONE ALTA-BASSA FIAMMA "AB" / PROGRESSIVO "PR"  
 "AB" HIGH-LOW / "PR" PROGRESSIVE VERSION

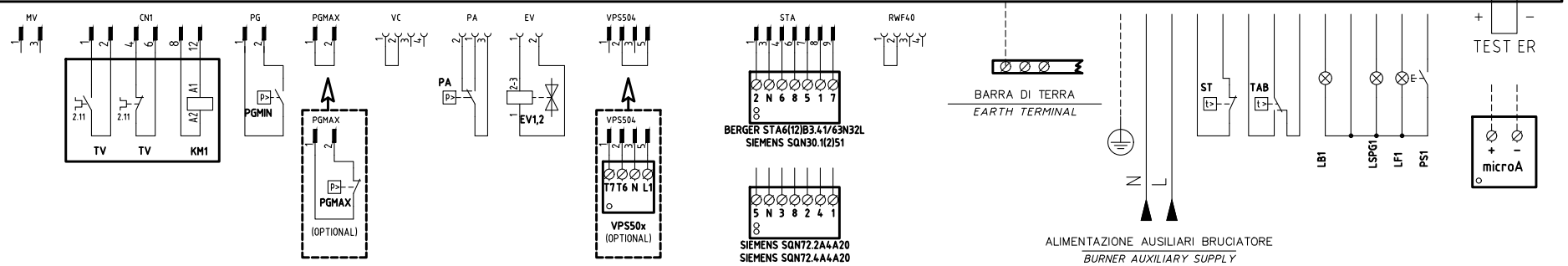

VEDI FOGLIO [3]  
 SEE SHEET [3]

03	MODULATOR UPDATE	10/09/14	U. PINTON
02	AGGIUNTO/ADDED RWF40.0.xx	07/03/14	U. PINTON
01	AGGIUNTO/ADDED "600V"	20/06/12	U. PINTON
REV.	MODIFICA	DATA	FIRME

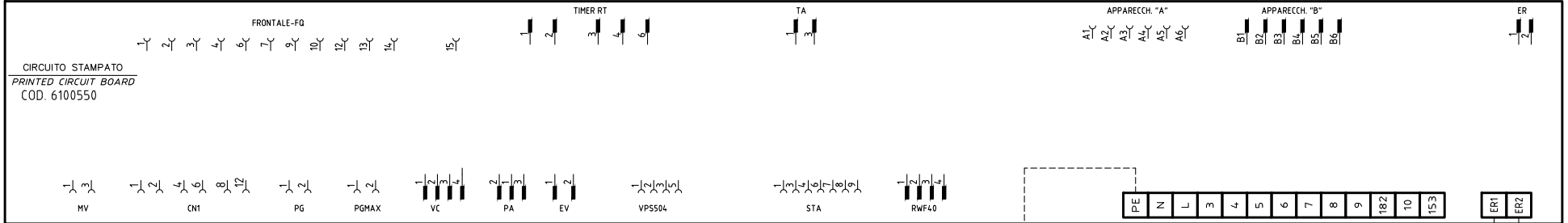
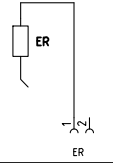
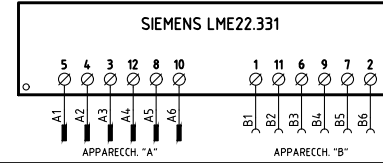
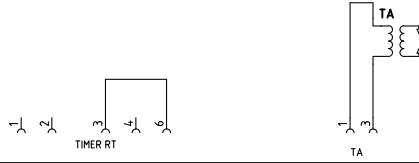
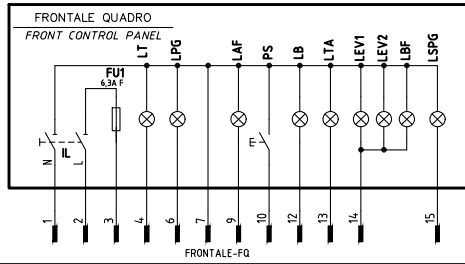

Impianto  
**TIPI/TYPES P61 ÷ P73/LX60/LX65/LX72**  
**MODELLO x-.AB(PR)(MD).x.xx.A.xx**

Descrizione  
**VERSIONE "MD" CON RWF5x.xx / 600V / KM3 E SMA+SMF**  
**VERSION "MD" WITH RWF5x.xx / 600V / KM3 AND SMA+SMF**

Ordine		Data	18/01/2012	PREC.	FOGLIO
Commessa		Revisione	03	/	1
Esecutore	U. PINTON	Data Controllato	10/09/2014	SEGUE	TOTALE
		Dis. N.	18 - 0236	2	5

VERSIONE MODULANTE "MD"  
"MD" MODULATING VERSION

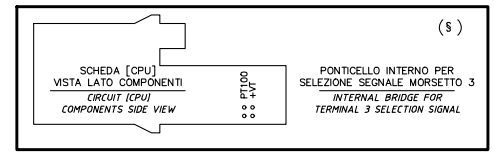
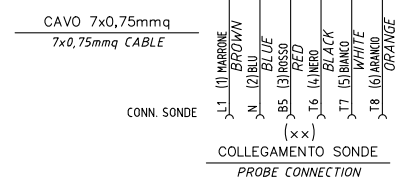
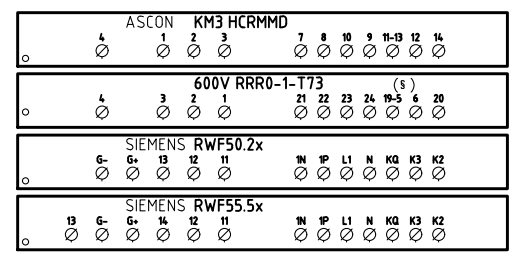
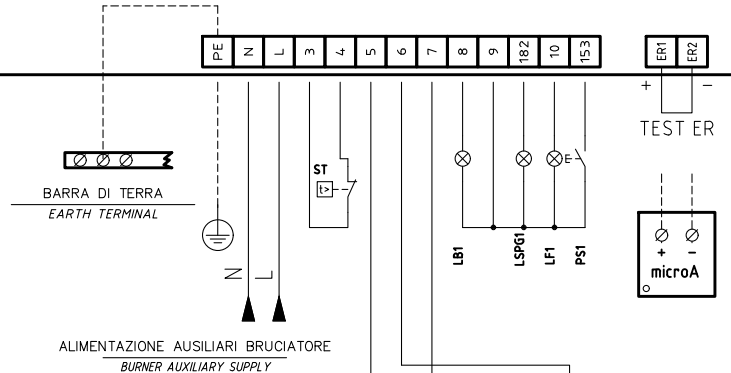
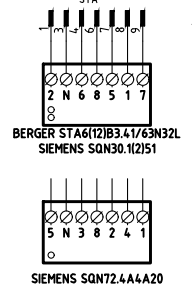
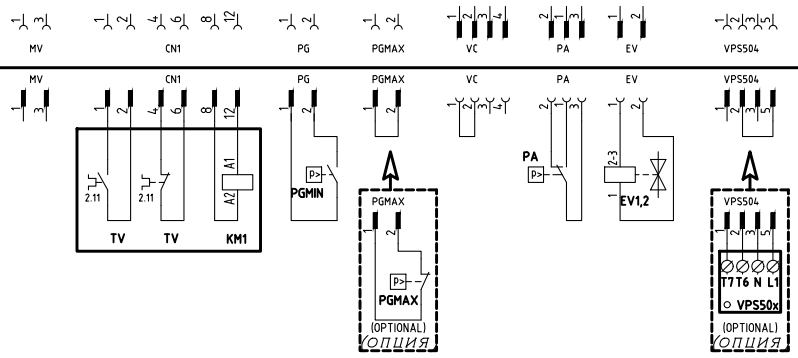
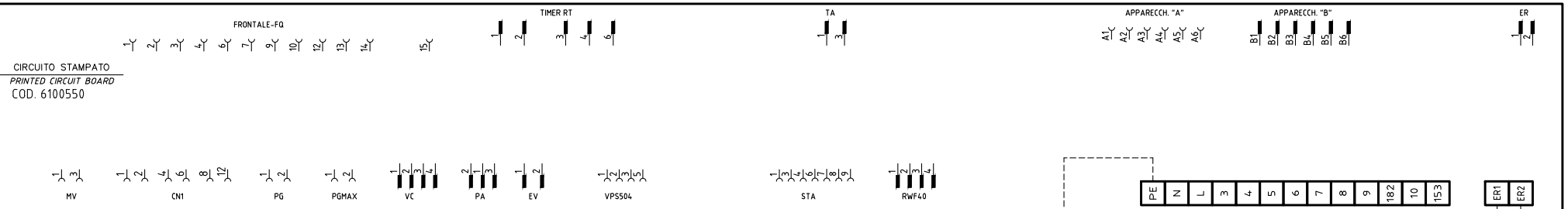
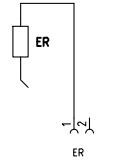
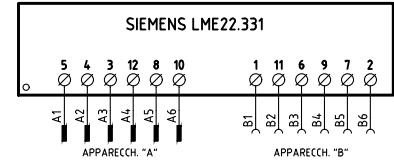
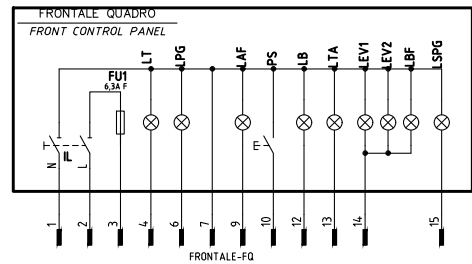

Data	18/01/2012	PREC.	FOGLIO
Revisione	03	1	2
Dis. N.	18 - 0236	SEGUE	TOTALE
		3	5

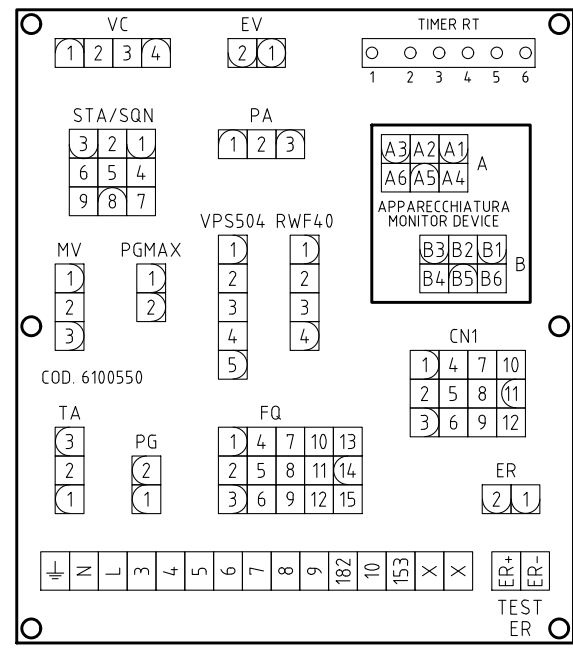
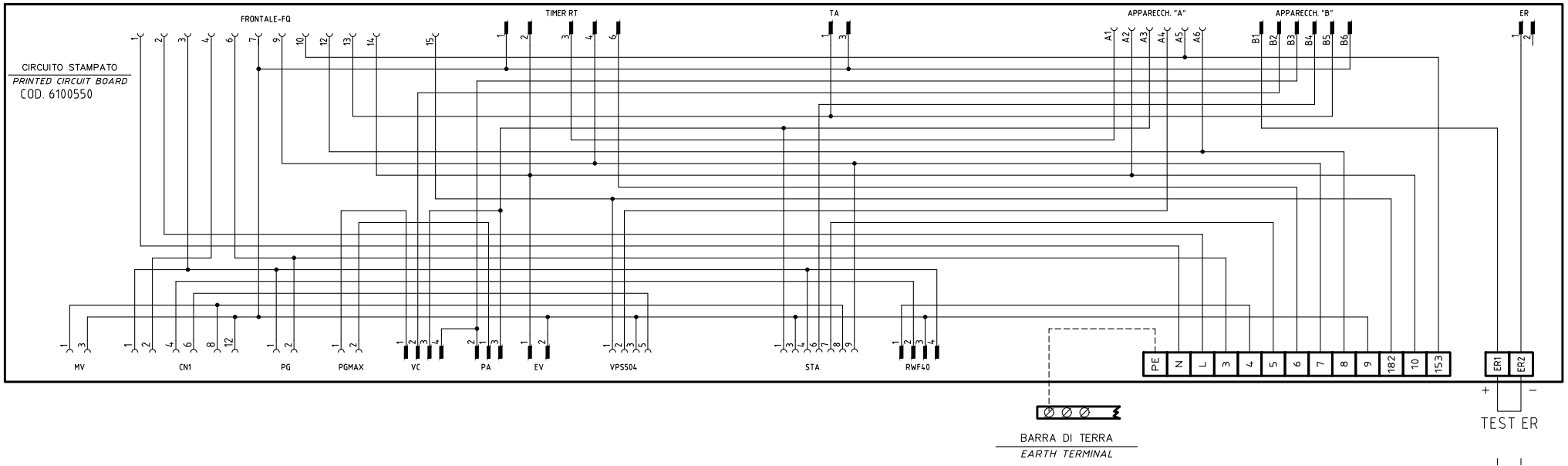

SERVOCOMANDO SERRANDA ARIA  
 AIR DAMPER ACTUATOR  
 BERGER STA6(12)B3.41/63N32L

ST2 ALTA FIAMMA  
 HIGH FLAME

ST0 SOSTA  
 STAND-BY

ST1 BASSA FIAMMA  
 LOW FLAME

MV NON USATA  
 NOT USED

SERVOCOMANDO SERRANDA ARIA (ALTERNATIVO)  
 AIR DAMPER ACTUATOR (ALTERNATIVE)  
 SIEMENS SQN30.1(2)51A

I ALTA FIAMMA  
 HIGH FLAME

II SOSTA  
 STAND-BY

III BASSA FIAMMA  
 LOW FLAME

V NON USATA  
 NOT USED

SERVOCOMANDO SERRANDA ARIA (ALTERNATIVO)  
 AIR DAMPER ACTUATOR (ALTERNATIVE)  
 SIEMENS SQN72.xA4A20

I (ROSSO)  
 I (RED) ALTA FIAMMA  
 HIGH FLAME

II (BLU)  
 II (BLUE) SOSTA  
 STAND-BY

III (ARANCIO)  
 III (ORANGE) BASSA FIAMMA  
 LOW FLAME

IV (NERO)  
 IV (BLACK) NON USATA  
 NOT USED

Data	18/01/2012	PREC.	FOGLIO
Revisione	03	2	3
Dis. N.	18 - 0236	SEGUE	TOTALE
		4	5

(xx)  
 ATTENZIONE COLLEGAMENTO SONDE CON CONNETTORE 7 POLI  
 WARNING PROBE CONNECTION WITH 7 PINS CONNECTOR

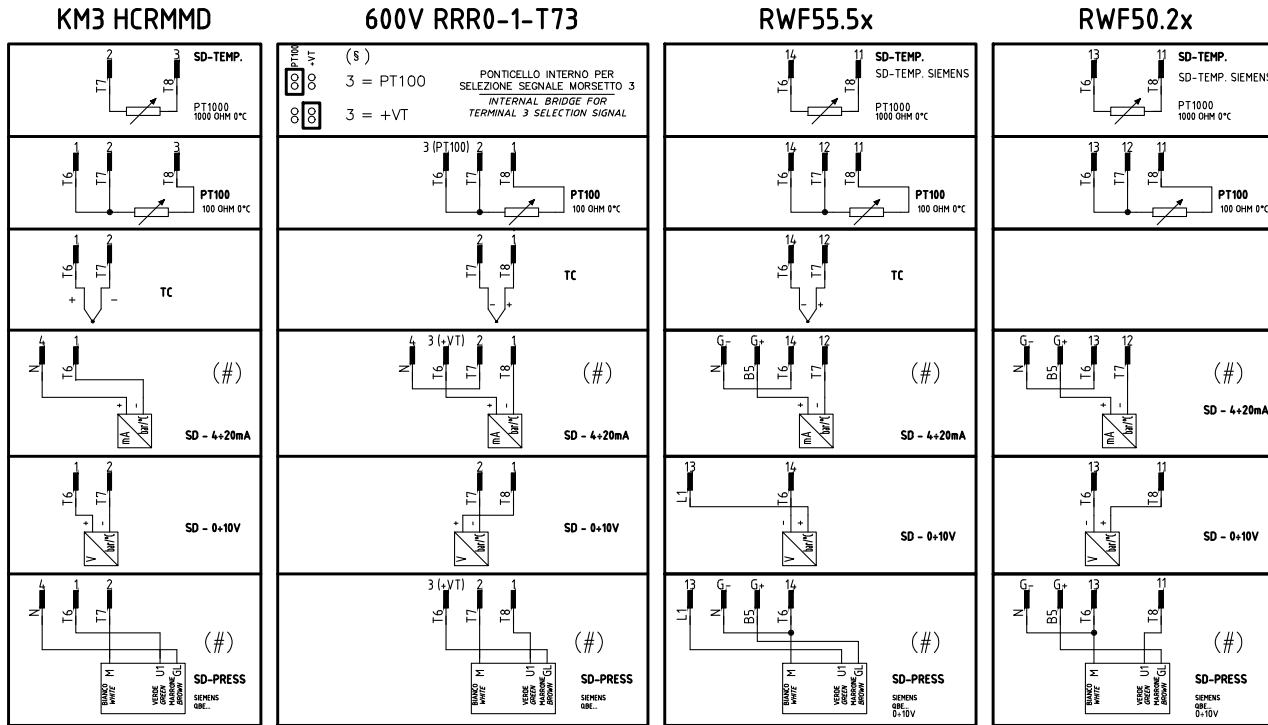

(#)  
 COLLEGAMENTO SOLO PER  
 TRASDUTTORI PASSIVI  
 TRANSDUCER PASSIVE  
 CONNECTION ONLY

QG - MC1  
 MORSETTIERA COLLEGAMENTO LINEA E MOTORE TRIFASE  
 MOTOR THREE PHASES AND ELECTRIC SUPPLY CONNECTION TERMINAL BOARD

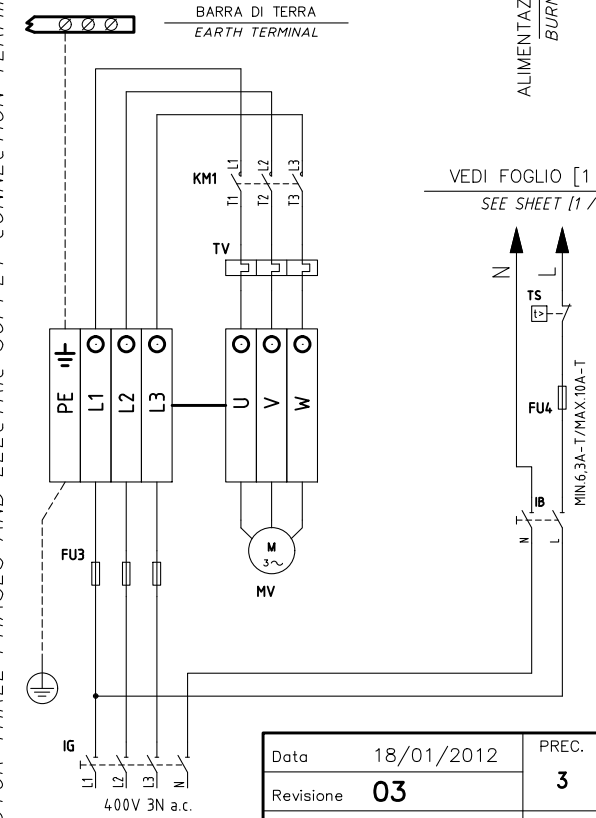

VEDI FOGLIO [ 1 / 2 ]  
 SEE SHEET [ 1 / 2 ]

Data	18/01/2012	PREC.	FOGLIO
Revisione	03	3	4
Dis. N.	18 - 0236	SEGUE	TOTALE
		5	5

Sigla/Item	Funzione	Function
600V RRR0-1-T73	REGOLATORE MODULANTE (ALTERNATIVO)	BURNER MODULATOR (ALTERNATIVE)
BERGER STA6(12)B3.41/63N32L	SERVOCOMANDO SERRANDA ARIA	AIR DAMPER ACTUATOR
ER	ELETTRODO RILEVAZIONE FIAMMA	FLAME DETECTION ELECTRODE
EV1,2	ELETTROVALVOLE GAS (O GRUPPO VALVOLE)	GAS ELECTRO-VALVES (OR VALVES GROUP)
FU1	FUSIBILE DI LINEA	LINE FUSE
FU2	FUSIBILE AUSILIARIO	AUXILIARY FUSE
FU3	FUSIBILI LINEA MOTORE VENTILATORE	FAN MOTOR LINE FUSES
FU4	FUSIBILE DI LINEA	LINE FUSE
IB	INTERRUTTORE LINEA BRUCIATORE	BURNER LINE SWITCH
IG	INTERRUTTORE GENERALE	MAINS SWITCH
IL	INTERRUTTORE LINEA AUSILIARI	AUXILIARY LINE SWITCH
KM1	CONTATTORE MOTORE VENTILATORE	FAN MOTOR CONTACTOR
KM3 HCRMMD	REGOLATORE MODULANTE (ALTERNATIVO)	BURNER MODULATOR (ALTERNATIVE)
LAF	LAMPADA SEGNALAZIONE ALTA FIAMMA BRUCIATORE	BURNER IN HIGH FLAME INDICATOR LIGHT
LB	LAMPADA SEGNALAZIONE BLOCCO BRUCIATORE	INDICATOR LIGHT FOR BURNER LOCK-OUT
LB1	LAMPADA SEGNALAZIONE BLOCCO BRUCIATORE	INDICATOR LIGHT FOR BURNER LOCK-OUT
LBF	LAMPADA SEGNALAZIONE BASSA FIAMMA BRUCIATORE	BURNER IN LOW FLAME INDICATOR LIGHT
LEV1	LAMPADA SEGNALAZIONE APERTURA [EV1]	INDICATOR LIGHT FOR OPENING OF ELECTRO-VALVE [EV1]
LEV2	LAMPADA SEGNALAZIONE APERTURA [EV2]	INDICATOR LIGHT FOR OPENING OF ELECTRO-VALVE [EV2]
LF1	LAMPADA SEGNALAZIONE FUNZIONAMENTO BRUCIATORE	INDICATOR LIGHT BURNER OPERATION
LPG	LAMPADA SEGNALAZIONE PRESENZA GAS IN RETE	INDICATOR LIGHT FOR PRESENCE OF GAS IN THE NETWORK
LSPG	LAMPADA SEGNALAZIONE BLOCCO CONTROLLO TENUTA VALVOLE	INDICATOR LIGHT FOR LEAKAGE OF VALVES
LSPG1	LAMPADA SEGNALAZIONE BLOCCO CONTROLLO TENUTA VALVOLE	INDICATOR LIGHT FOR LEAKAGE OF VALVES
LT	LAMPADA SEGNALAZIONE BLOCCO TERMICO	INDICATOR LIGHT FOR MOTOR OVERLOAD THERMAL CUTOUT
LTA	LAMPADA SEGNALAZIONE TRASFORMATORE DI ACCENSIONE	IGNITION TRANSFORMER INDICATOR LIGHT
MV	MOTORE VENTILATORE	FAN MOTOR
PA	PRESSOSTATO ARIA	AIR PRESSURE SWITCH
PGMAX	PRESSOSTATO GAS DI MASSIMA PRESSIONE	MAXIMUM PRESSURE GAS SWITCH
PGMIN	PRESSOSTATO GAS DI MINIMA PRESSIONE	MINIMUM GAS PRESSURE SWITCH
PS	PULSANTE SBLOCCO FIAMMA	FLAME UNLOCK BUTTON
PS1	PULSANTE SBLOCCO FIAMMA	FLAME UNLOCK BUTTON
PT100	SONDA DI TEMPERATURA	TEMPERATURE PROBE
RWF50.2x	REGOLATORE MODULANTE (ALTERNATIVO)	BURNER MODULATOR (ALTERNATIVE)
RWF55.5x	REGOLATORE MODULANTE (ALTERNATIVO)	BURNER MODULATOR (ALTERNATIVE)
SD-PRESS	SONDA DI PRESSIONE	PRESSURE PROBE
SD-TEMP.	SONDA DI TEMPERATURA	TEMPERATURE PROBE
SD - 0+10V	TRASDUTTORE USCITA IN TENSIONE	TRANSDUCER VOLTAGE OUTPUT
SD - 4+20mA	TRASDUTTORE USCITA IN CORRENTE	TRANSDUCER CURRENT OUTPUT
SIEMENS LME22.331	APPARECCHIATURA CONTROLLO FIAMMA	CONTROL BOX
SIEMENS SQN30.1(2)51	SERVOCOMANDO SERRANDA ARIA (ALTERNATIVO)	AIR DAMPER ACTUATOR (ALTERNATIVE)
SIEMENS SQN72.2A4A20	SERVOCOMANDO SERRANDA ARIA (ALTERNATIVO)	AIR DAMPER ACTUATOR (ALTERNATIVE)
SIEMENS SQN72.4A4A20	SERVOCOMANDO SERRANDA ARIA (ALTERNATIVO)	AIR DAMPER ACTUATOR (ALTERNATIVE)
SMA	SELETTORE MANUALE/AUTOMATICO	MANUAL/AUTOMATIC SWITCH
SMF	SELETTORE MANUALE FUNZIONAMENTO MIN-0-MAX	MIN-0-MAX MANUAL OPERATION SWITCH
ST	SERIE TERMOSTATI/PRESSOSTATI	SERIES OF THERMOSTATS OR PRESSURE SWITCHES
TA	TRASFORMATORE DI ACCENSIONE	IGNITION TRANSFORMER
TAB	TERMOSTATO/PRESSOSTATO ALTA-BASSA FIAMMA	HIGH-LOW THERMOSTAT/PRESSURE SWITCHES
TC	TERMOCOPPIA	THERMOCOUPLE
TS	TERMOSTATO/PRESSOSTATO DI SICUREZZA	SAFETY THERMOSTAT OR PRESSURE SWITCH
TV	TERMICO MOTORE VENTILATORE	FAN MOTOR THERMAL
VPS50x	CONTROLLO DI TENUTA VALVOLE GAS (OPTIONAL)	GAS PROVING SYSTEM (OPTIONAL)
microA	MICROAMPEROMETRO	MICROAMMETER

Data	18/01/2012	PREC.	FOGLIO
Revisione	03	4	5
Dis. N.	18 - 0236	SEQUE	TOTALE
		/	5