	Impianto	Ordine	Data	22/05/2015	PREC.	FOGLIO
	TIPI/TYPES R91A ÷ R520A / TP91A ÷ TP520A MODELLO/MODEL x-.PR(MD).x.xx.A.1.xx.EA		Commissa	Data Controllato	/	1
	Descrizione LMV20.100 + COD. 6100561 + COD. 6100566		Esecutore	Controllato		
			U. PINTON	G. SCATTOLIN	Dis. N.	09 - 0429-YE
				2		12

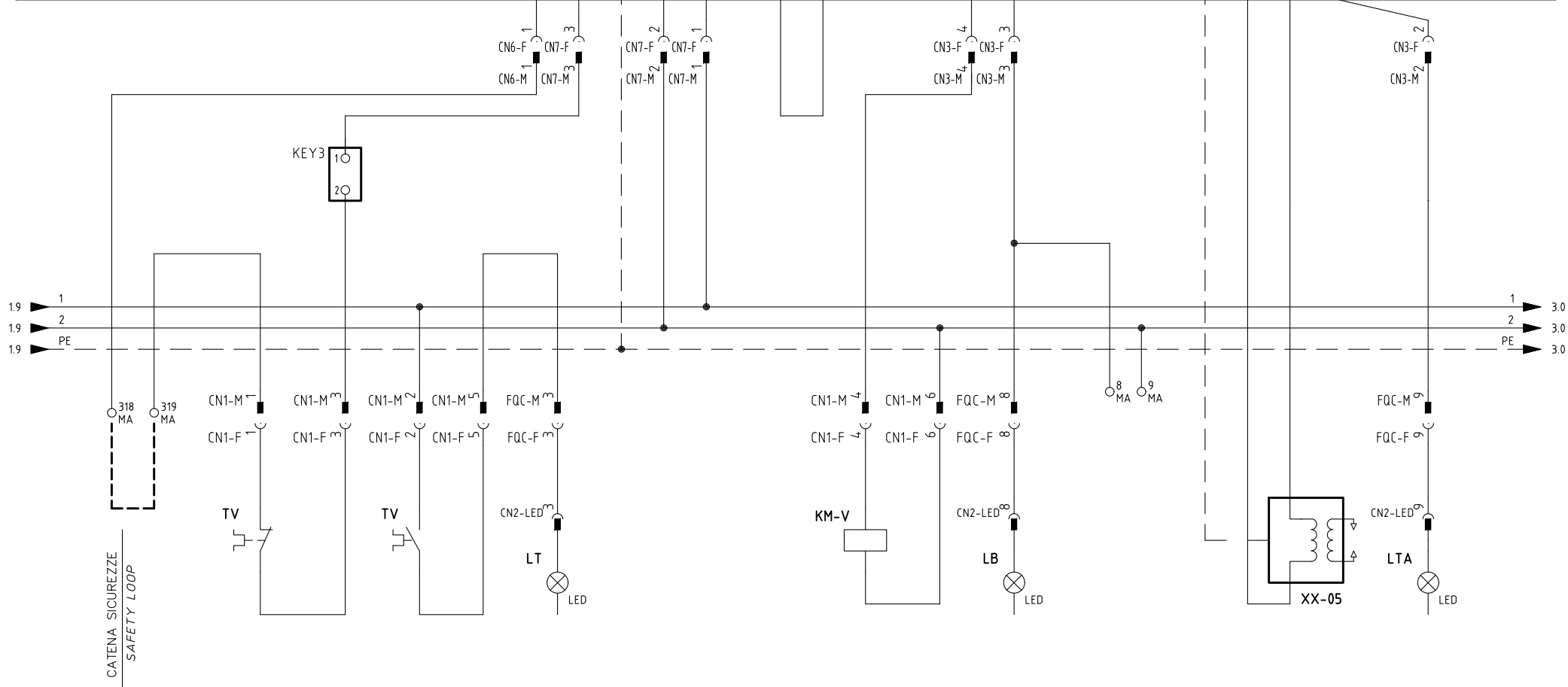

CATENA SICUREZZE
SAFETY LOOP

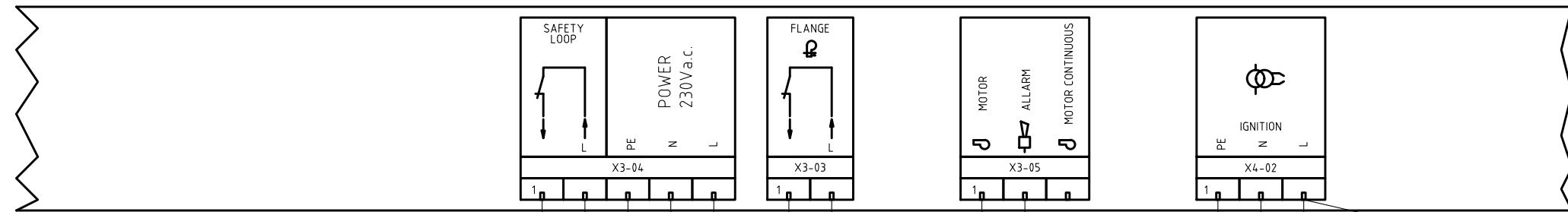

Data	22/05/2015	PREC.	FOGLIO
Revisione	00	1	2
Dis. N.	09 - 0429-YE	SEGUE	TOTALE
		3	12

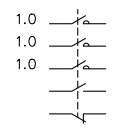
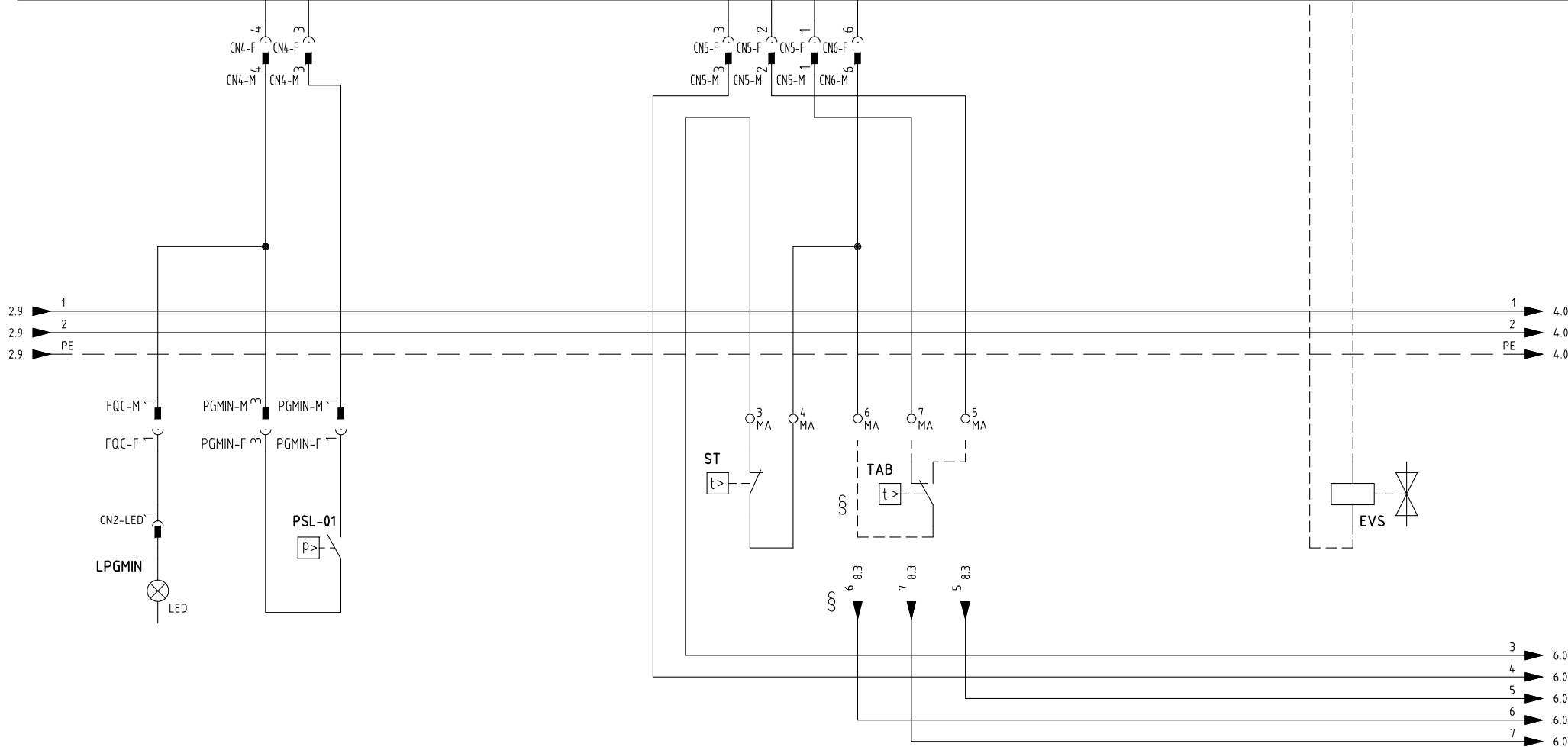
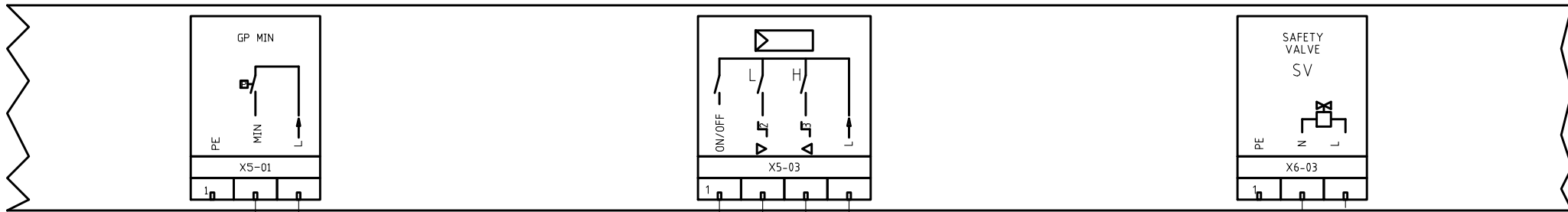

§

VERSIONE (PR) / VERSIONE (MD) CON RWF.. / 600V / KM3
 (PR) VERSION / (MD) VERSION WITH RWF.. / 600V / KM3

Data	22/05/2015	PREC.	FOGLIO
Revisione	00	2	3
Dis. N.	09 - 0429-YE	SEGUE	TOTALE
		4	12

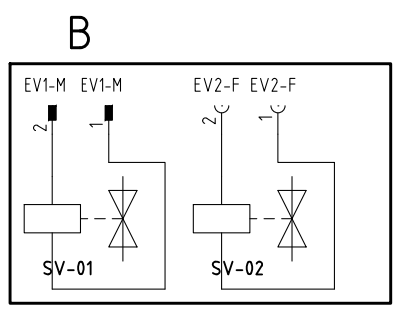
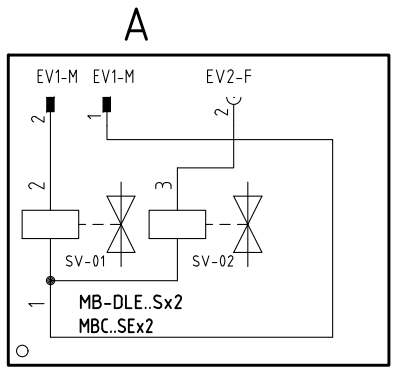
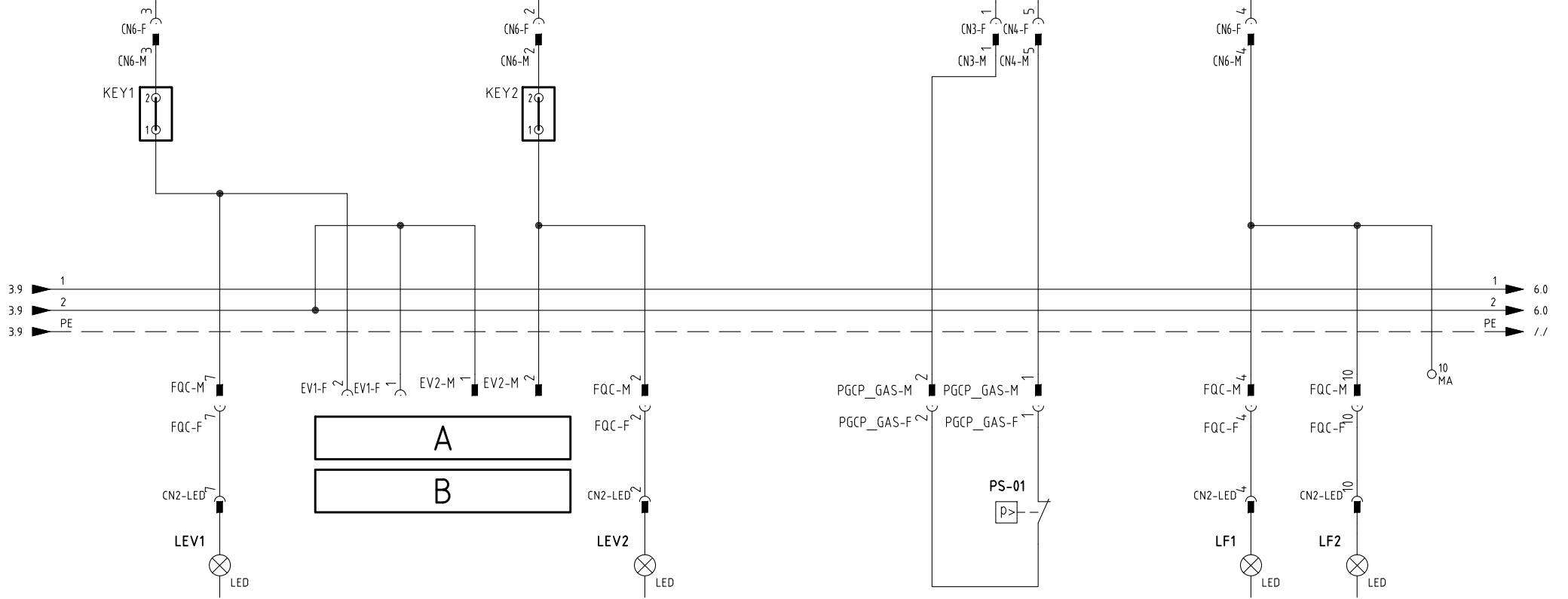
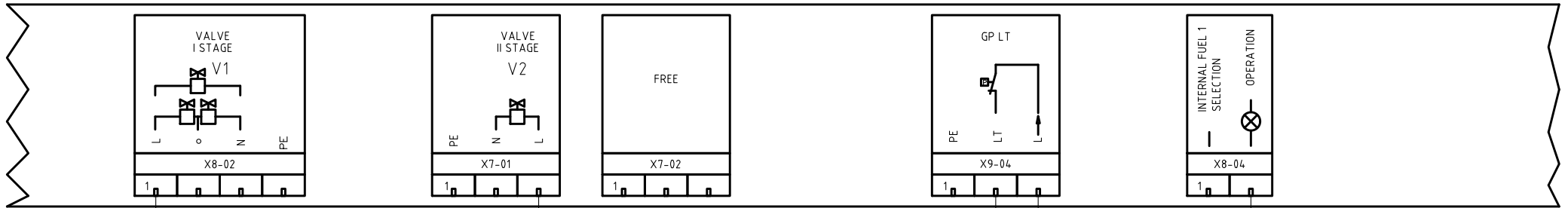

Data	22/05/2015	PREC.	FOGLIO
Revisione	00	3	4
Dis. N.	09 - 0429-YE	SEGUE	TOTALE
		5	12

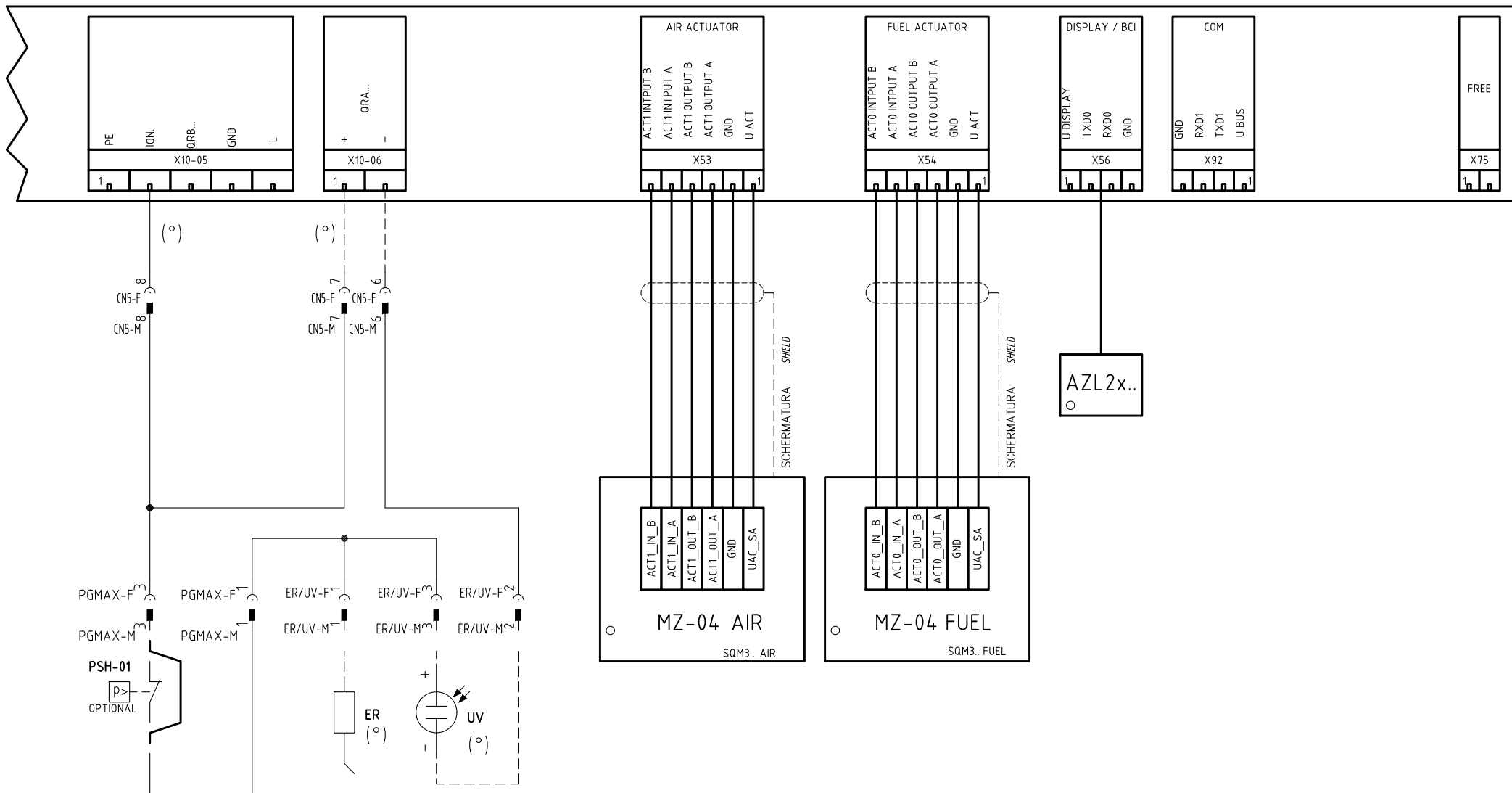

(°)

SONDA "UV" IN ALTERNATIVA A ELETTRODO "ER"
 "UV" PROBE ALTERNATIVE TO "ER"

Data	22/05/2015	PREC.	FOGLIO
Revisione	00	4	5
Dis. N.	09 - 0429-YE	SEGUE	TOTALE
		6	12

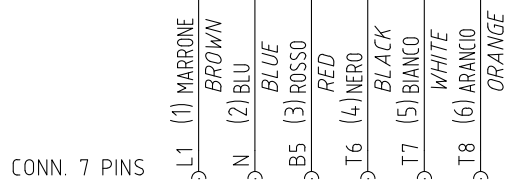
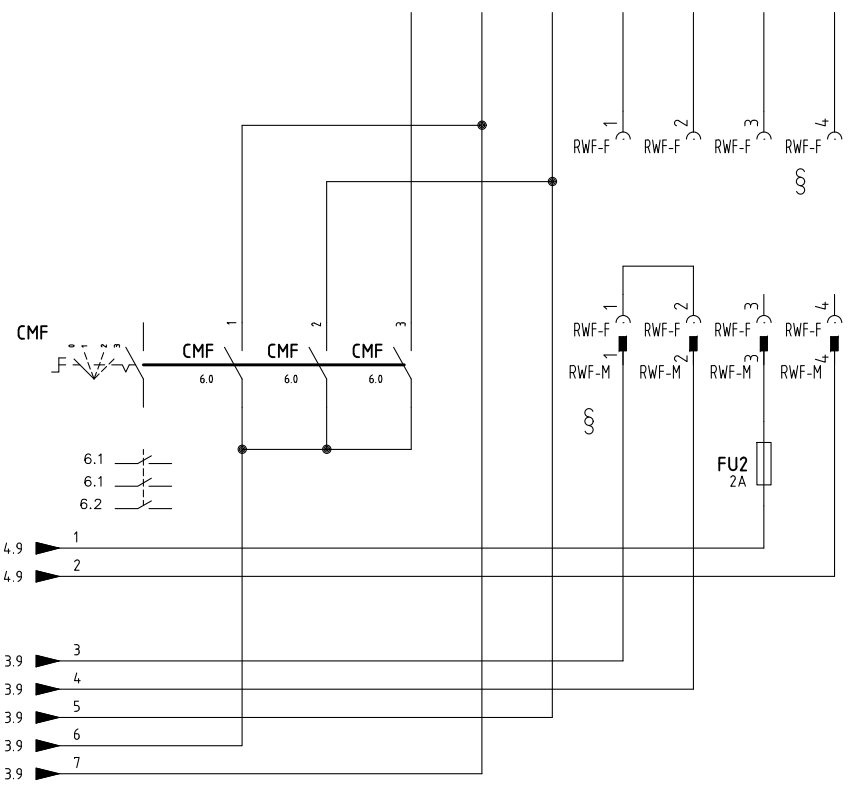
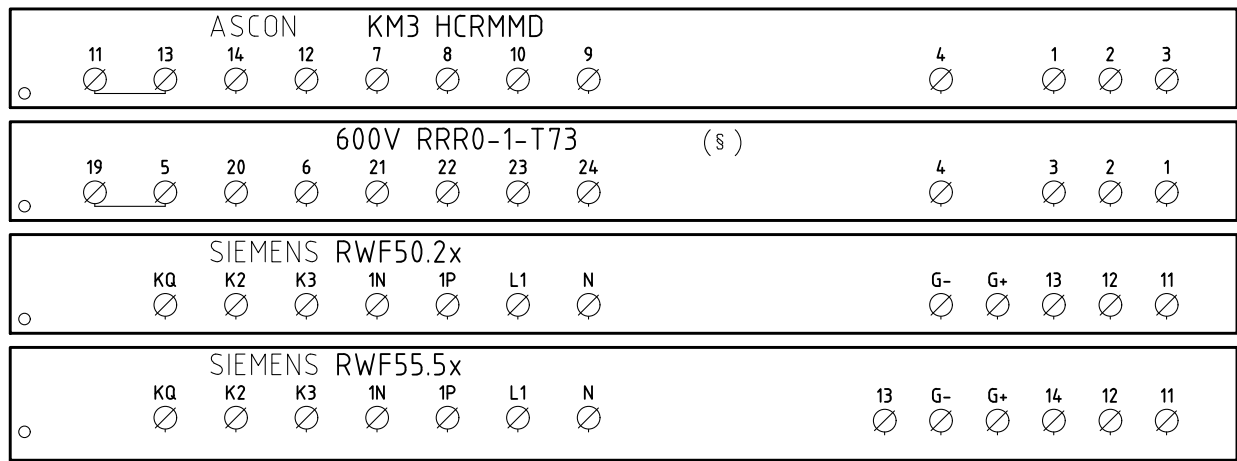

CAVO 7x0,75mmq
7x0,75mmq CABLE

(xx)
ATTENZIONE COLLEGAMENTO SONDE CON CONNETTORE 7 POLI
WARNING PROBE CONNECTION WITH 7 PINS CONNECTOR

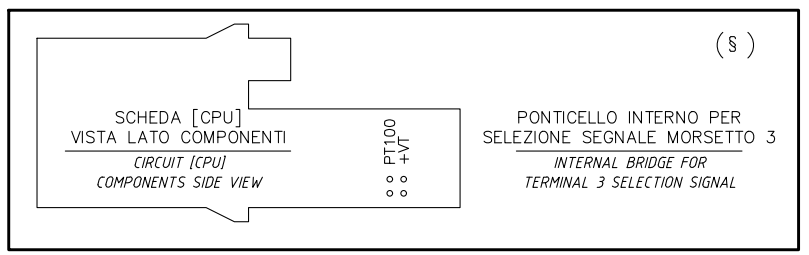

§
VERSIONE (PR) / VERSIONE (MD) CON RWF.. / 600V / KM3
(PR) VERSION / (MD) VERSION WITH RWF.. / 600V / KM3

Data	22/05/2015	PREC.	FOGLIO
Revisione	00	5	6
Dis. N.	09 - 0429-YE	SEGUE	TOTALE
		7	12

(xx)

ATTENZIONE COLLEGAMENTO SONDE CON CONNETTORE 7 POLI
WARNING PROBE CONNECTION WITH 7 PINS CONNECTOR

KM3 HCRMMD

600V RRR0-1-T73

RWF55.5x

RWF50.2x

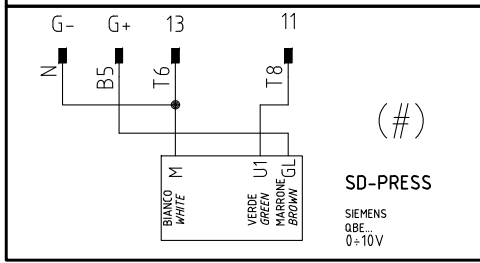
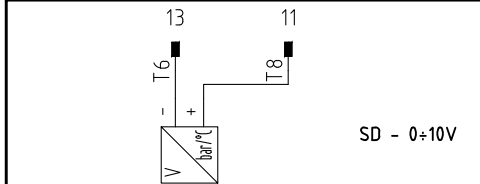
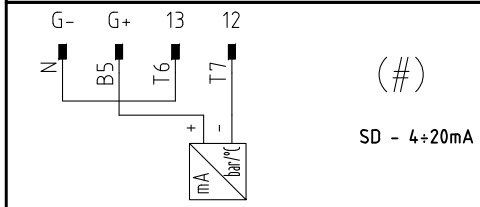
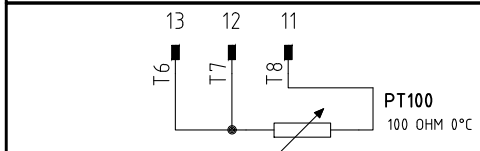
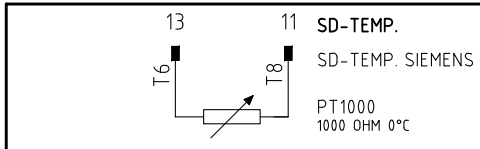
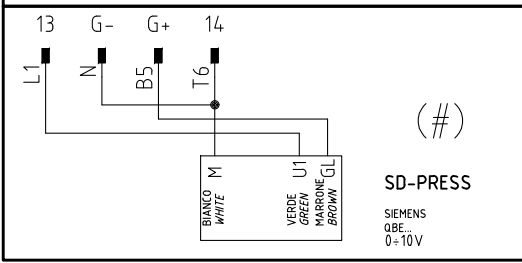
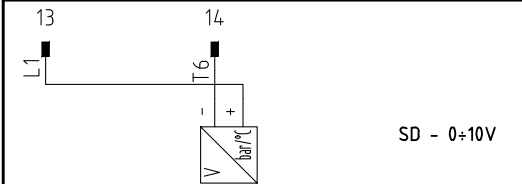
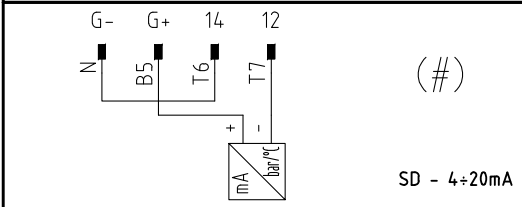
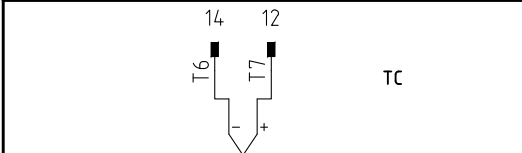
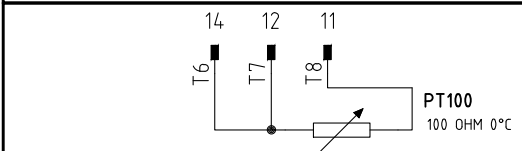
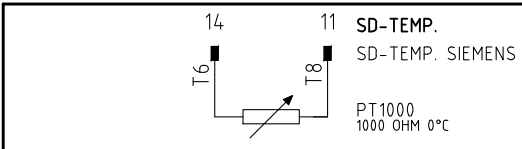
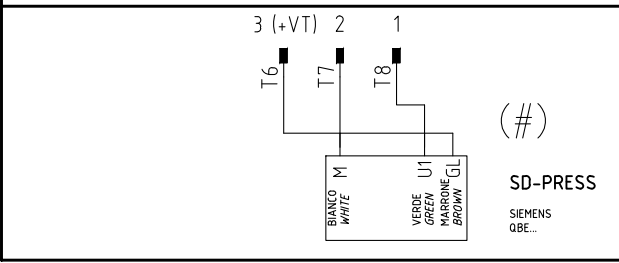
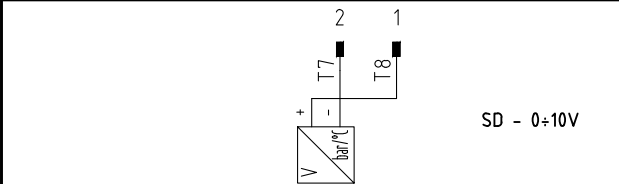
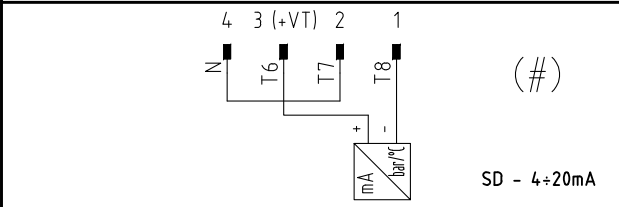
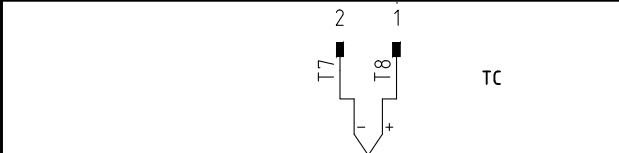
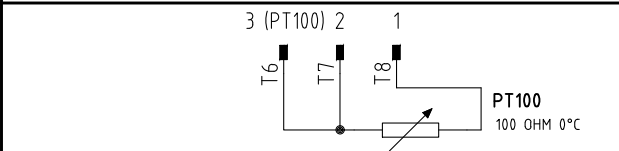
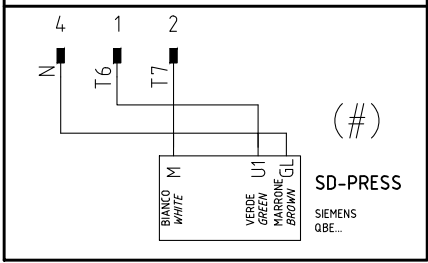
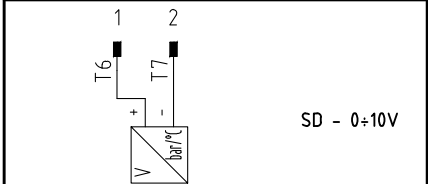
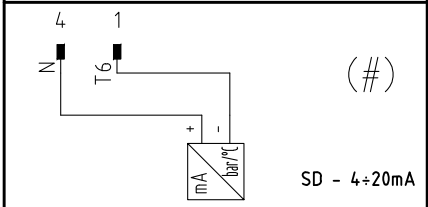
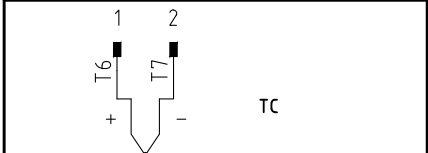
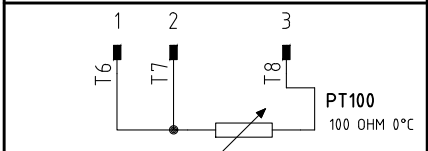
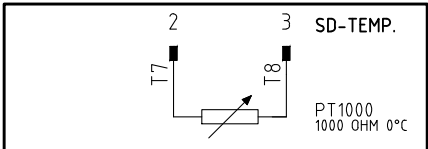

(#)

COLLEGAMENTO SOLO PER TRASDUTTORI PASSIVI
TRASDUCER PASSIVE CONNECTION ONLY

Data	22/05/2015	PREC.	FOGLIO
Revisione	00	6	7
Dis. N.	09 - 0429-YE	SEGUE	TOTALE
		8	12

QUADRO QG - MORSETTIERA MA
MORSETTIERA ALIMENTAZIONE BRUCIATORE
BURNER SUPPLY TERMINAL BOARD

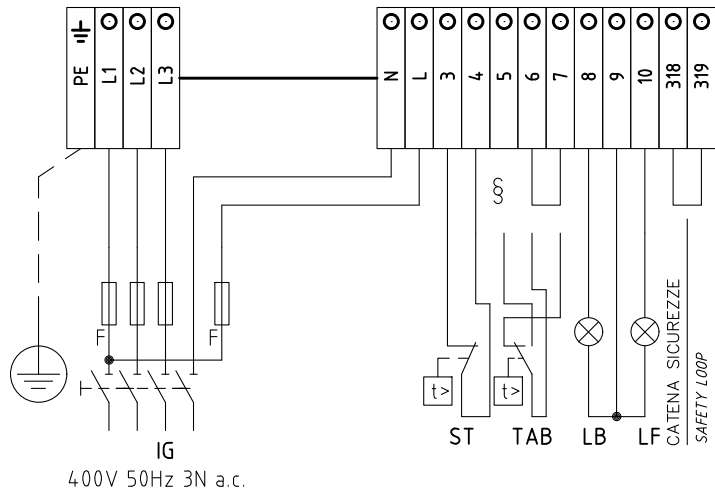

VERSIONE (PR) / VERSIONE (MD) CON RWF.. / 600V / KM3
 (PR) VERSION / (MD) VERSION WITH RWF.. / 600V / KM3

SE USATO "TAB" O "MD", TOGLIERE IL PONTE TRA I MORSETTI 6 - 7
 IF USED "TAB" OR "MD", REMOVE THE BRIDGE BETWEEN TERMINALS 6 - 7

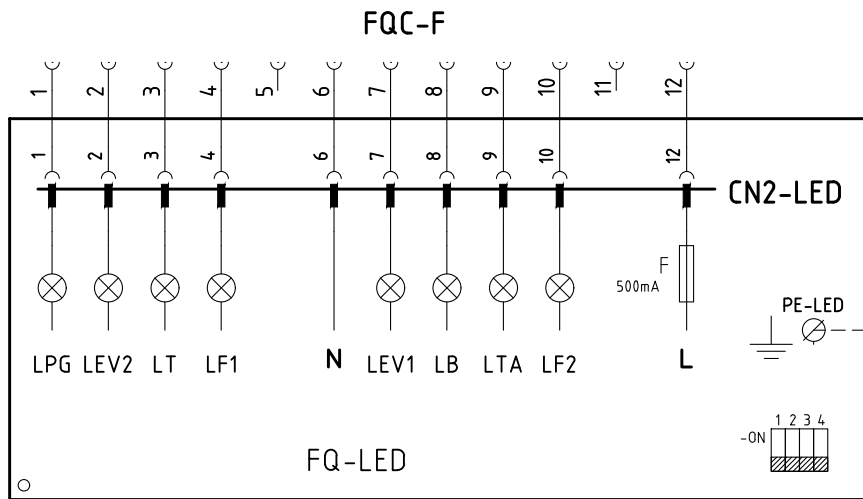
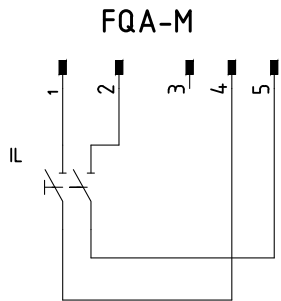
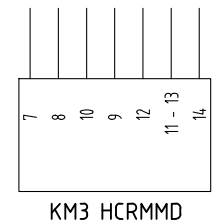
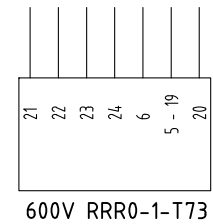
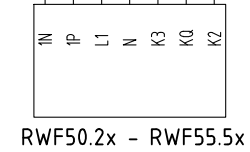
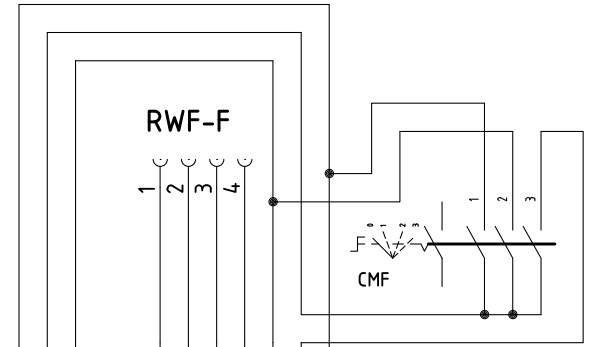

Data	22/05/2015	PREC.	FOGLIO
Revisione	00	7	8
Dis. N.	09 - 0429-YE	SEGUE	TOTALE
		9	12

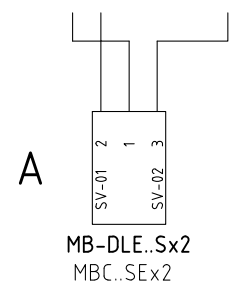
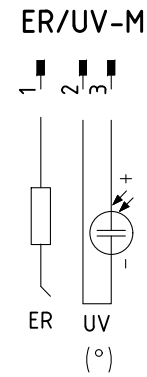
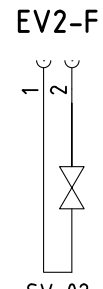
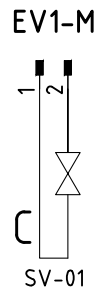
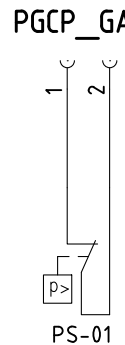
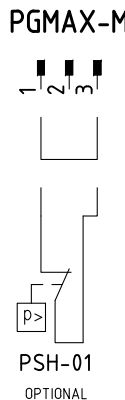
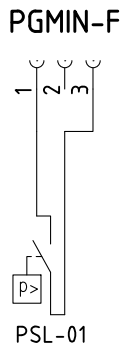
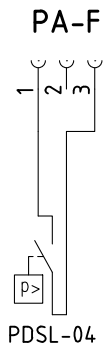
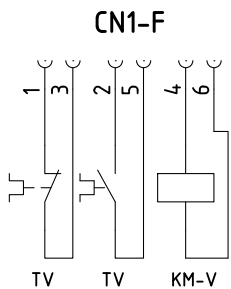

(°)
SONDA "UV" IN ALTERNATIVA A ELETTRODO "ER"
"UV" PROBE ALTERNATIVE TO "ER"

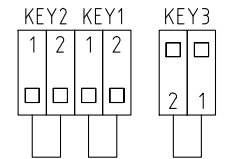
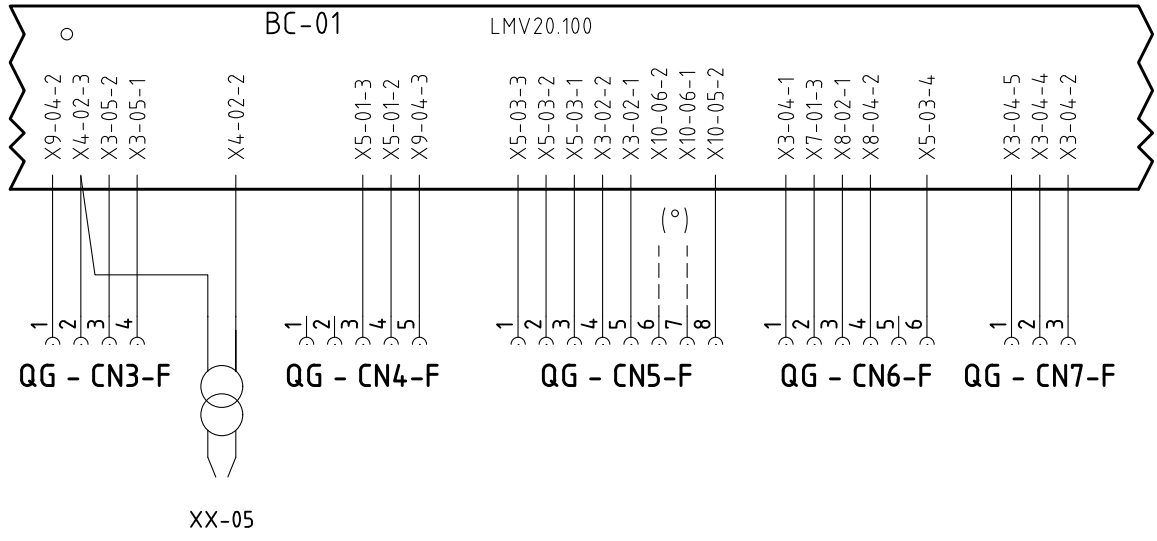

Data	22/05/2015	PREC.	FOGLIO
Revisione	00	8	9
Dis. N.	09 - 0429-YE	SEGUE	TOTALE
		10	12

Sigla/Item	Foglio/Sheet	Funzione	Function
600V RRR0-1-T73	6	REGOLATORE MODULANTE (ALTERNATIVO)	BURNER MODULATOR (ALTERNATIVE)
AZL2x..	5	INTERFACCIA UTENTE	USER INTERFACE
BC-01	1	APPARECCHIATURA DI COMANDO	CONTROL SCHEME
CMF	6	COMMUT. MANUALE FUNZ. 0)FERMO 1)ALTA FIAMMA 2)BASSA FIAMMA 3)AUTOMATICO	MANUAL SWITCH 0)OFF 1)HIGH FLAME 2)LOW FLAME 3)AUTOMATIC
ER	5	ELETTRODO RILEVAZIONE FIAMMA	FLAME DETECTION ELECTRODE
EVS	3	ELETTROVALVOLA GAS DI SICUREZZA (OPTIONAL)	SAFETY GAS SOLENOID VALVE (OPTIONAL)
FQ-LED	8	PANNELLO FRONTALE (LED)	FRONT PANEL (LED)
FU1	1	FUSIBILE AUSILIARIO	AUXILIARY FUSE
FU2	6	FUSIBILE	FUSE
FU-A	1	FUSIBILI DI LINEA	LINE FUSES
FU-B	1	FUSIBILE DI LINEA	LINE FUSE
IG	1	INTERRUTTORE GENERALE	MAINS SWITCH
IL	1	INTERRUTTORE LINEA AUSILIARI	AUXILIARY LINE SWITCH
KM3 HCRMMD	6	REGOLATORE MODULANTE (ALTERNATIVO)	BURNER MODULATOR (ALTERNATIVE)
KM-V	2	CONTATTORE MOTORE VENTILATORE	FAN MOTOR CONTACTOR
LB	2	LAMPADA SEGNALAZIONE BLOCCO BRUCIATORE	INDICATOR LIGHT FOR BURNER LOCK-OUT
LEV1	4	LAMPADA SEGNALAZIONE APERTURA [EV1]	INDICATOR LIGHT FOR OPENING OF ELECTRO-VALVE [EV1]
LEV2	4	LAMPADA SEGNALAZIONE APERTURA [EV2]	INDICATOR LIGHT FOR OPENING OF ELECTRO-VALVE [EV2]
LF1	4	LAMPADA SEGNALAZIONE FUNZIONAMENTO BRUCIATORE	INDICATOR LIGHT BURNER OPERATION
LF2	4	LAMPADA SEGNALAZIONE FUNZIONAMENTO BRUCIATORE	INDICATOR LIGHT BURNER OPERATION
LPGMIN	3	LAMPADA SEGNALAZIONE PRESENZA GAS IN RETE	INDICATOR LIGHT FOR PRESENCE OF GAS IN THE NETWORK
LT	2	LAMPADA SEGNALAZIONE BLOCCO TERMICO MOTORE VENTILATORE	INDICATOR LIGHT FOR FAN MOTOR OVERLOAD THERMAL CUTOUT
LTA	2	LAMPADA SEGNALAZIONE TRASFORMATORE DI ACCENSIONE	IGNITION TRANSFORMER INDICATOR LIGHT
M-01	1	MOTORE VENTILATORE	FAN MOTOR
MB-DLE..Sx2	4	GRUPPO VALVOLE GAS	GAS VALVES GROUP
MBC..SEx2	4	GRUPPO VALVOLE GAS (ALTERNATIVO)	GAS VALVES GROUP (ALTERNATIVE)
MZ-04 AIR	5	SERVOCOMANDO SERRANDA ARIA	AIR DAMPER ACTUATOR
MZ-04 FUEL	5	SERVOCOMANDO COMBUSTIBILE	FUEL ACTUATOR
PDSL-04	1	PRESSOSTATO ARIA	AIR PRESSURE SWITCH
PS-01	4	PRESSOSTATO GAS CONTROLLO PERDITE	GAS LEAKAGE PRESSURE SWITCH
PSH-01	5	PRESSOSTATO GAS DI MASSIMA PRESSIONE (OPTIONAL)	MAXIMUM PRESSURE GAS SWITCH (OPTIONAL)
PSL-01	3	PRESSOSTATO GAS DI MINIMA PRESSIONE	MINIMUM GAS PRESSURE SWITCH

Data	22/05/2015	PREC.	FOGLIO
Revisione	00	9	10
Dis. N.	09 - 0429-YE	SEGUE	TOTALE
		11	12

Sigla/Item	Foglio/Sheet	Funzione	Function
PT100	7	SONDA DI TEMPERATURA	TEMPERATURE PROBE
RWF50.2x	6	REGOLATORE MODULANTE	BURNER MODULATOR
RWF55.5x	6	REGOLATORE MODULANTE (ALTERNATIVO)	BURNER MODULATOR (ALTERNATIVE)
SD-PRESS	7	SONDA DI PRESSIONE	PRESSURE PROBE
SD-TEMP.	7	SONDA DI TEMPERATURA	TEMPERATURE PROBE
SD - 0÷10V	7	TRASDUTTORE USCITA IN TENSIONE	TRANSDUCER VOLTAGE OUTPUT
SD - 4÷20mA	7	TRASDUTTORE USCITA IN CORRENTE	TRANSDUCER CURRENT OUTPUT
ST	3	SERIE TERMOSTATI/PRESSOSTATI	SERIES OF THERMOSTATS OR PRESSURE SWITCHES
SV-01	4	ELETTROVALVOLA GAS LATO RETE	UPSTREAM GAS SOLENOID VALVE
SV-02	4	ELETTROVALVOLA GAS LATO BRUCIATORE	DOWNSTREAM GAS SOLENOID VALVE
TAB	3	TERMOSTATO/PRESSOSTATO ALTA-BASSA FIAMMA	HIGH-LOW THERMOSTAT/PRESSURE SWITCHES
TC	7	TERMOCOPPIA	THERMOCOUPLE
TV	1	TERMICO MOTORE VENTILATORE	FAN MOTOR THERMAL
UV	5	SONDA UV RILEVAZIONE FIAMMA	UV FLAME DETECTOR
XX-05	2	TRASFORMATORE DI ACCENSIONE	IGNITION TRANSFORMER

Data	22/05/2015	PREC.	FOGLIO
Revisione	00	10	11
Dis. N.	09 - 0429-YE	SEGUE	TOTALE
		12	12

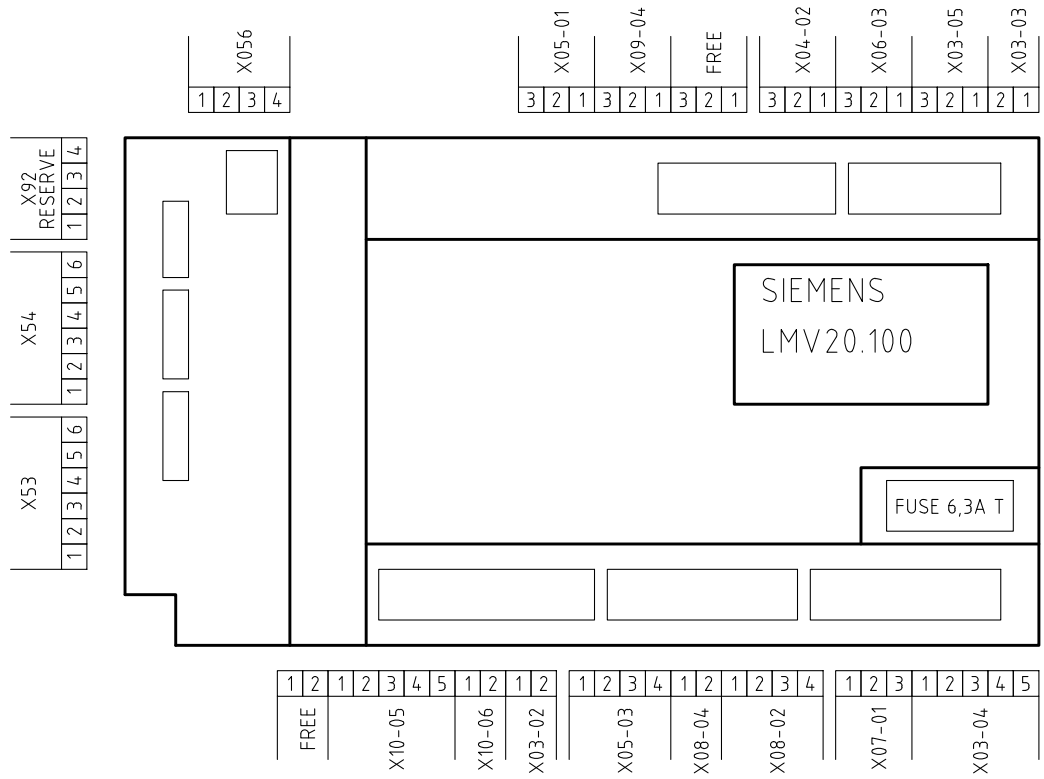

VISTA LATO COMPONENTI
COMPONENTS SIDE VIEW

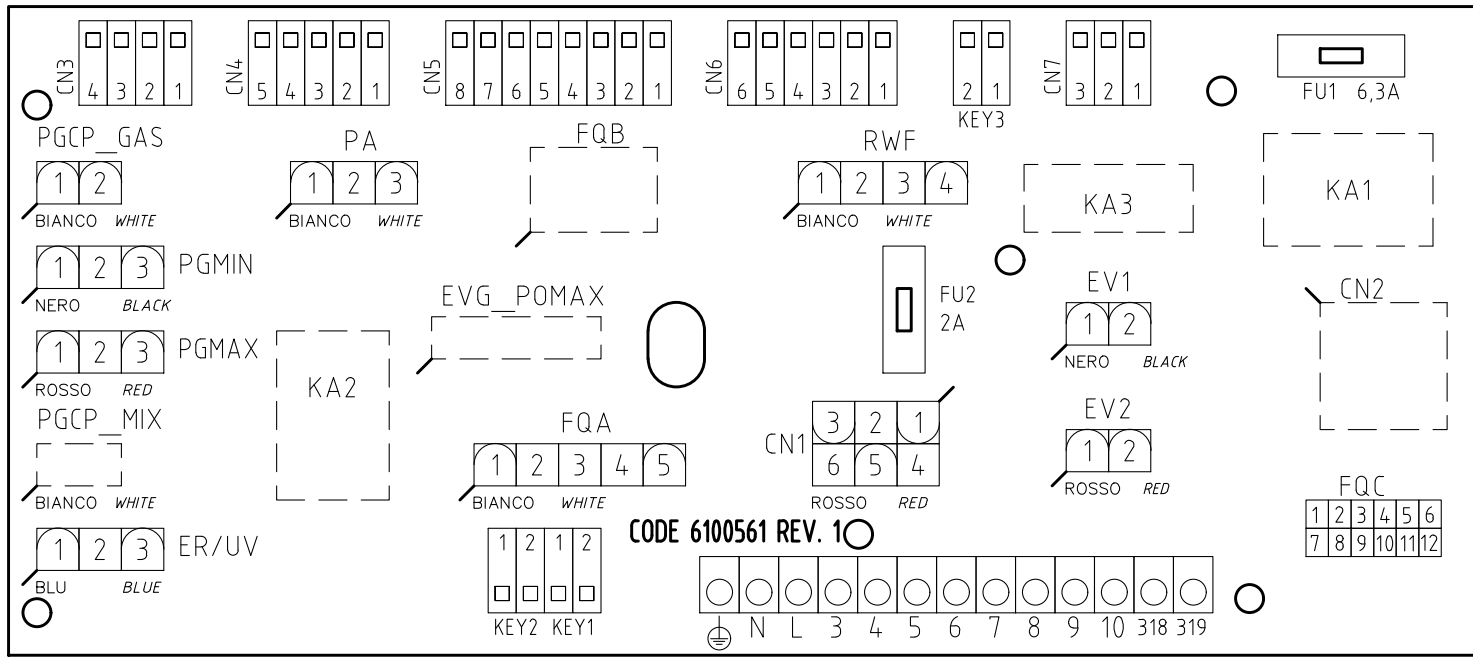

CODE 6100561 REV. 1

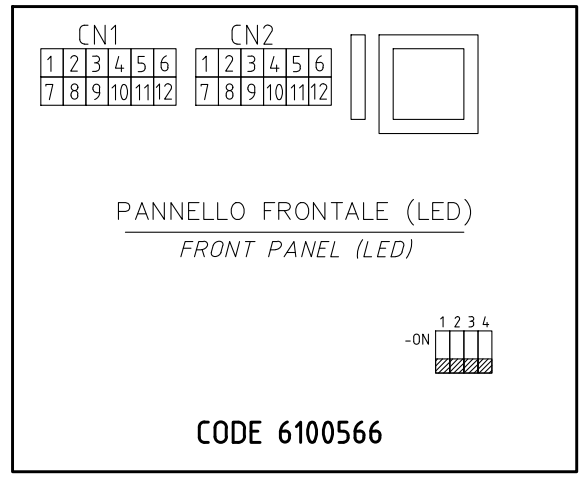

PANNELLO FRONTALE (LED)
FRONT PANEL (LED)

CODE 6100566

Data	22/05/2015	PREC.	FOGLIO
Revisione	00	11	12
Dis. N.	09 - 0429-YE	SEGUE	TOTALE
	/		12