

(x)  
 INSTALLATO SOLO SU ALCUNE VERSIONI  
 INSTALLED ON ANY VERSIONS ONLY

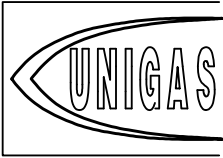

					Impianto <b>TIPO/TYPE KP60/.../KP93A - KR512A</b> MODELLO Mx.MD.x.xx.A.x.xx	Ordine  Comnessa Data Controllato 06/11/2014	Data 12/07/2013	PREC. /	FOGLIO 1	
					Descrizione <b>CON MULTI-TERMOSTATO MCX06C</b> <b>WITH MCX06C MULTI-THERMOSTAT</b>	Esecutore U. PINTON	Controllato E. CAVALLI	Revisione 01	SEGUE 2	TOTALE 11
01	ADDED "RWF55" AND "KM3" REGULATOR	06/11/14	U. PINTON			Dis. N.	05 - 1001			
REV.	MODIFICA	DATA	FIRME							

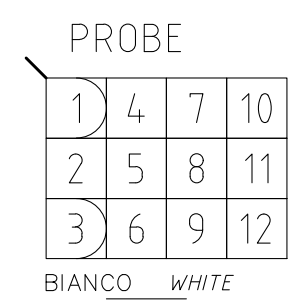
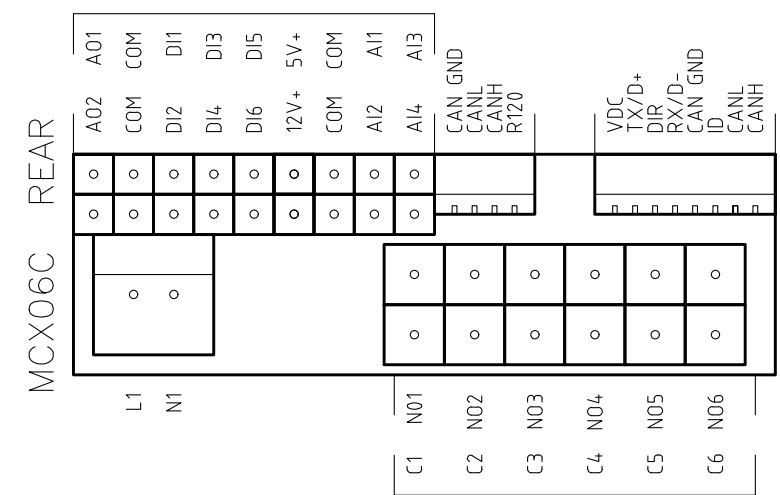
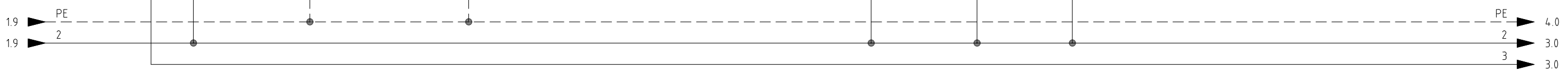
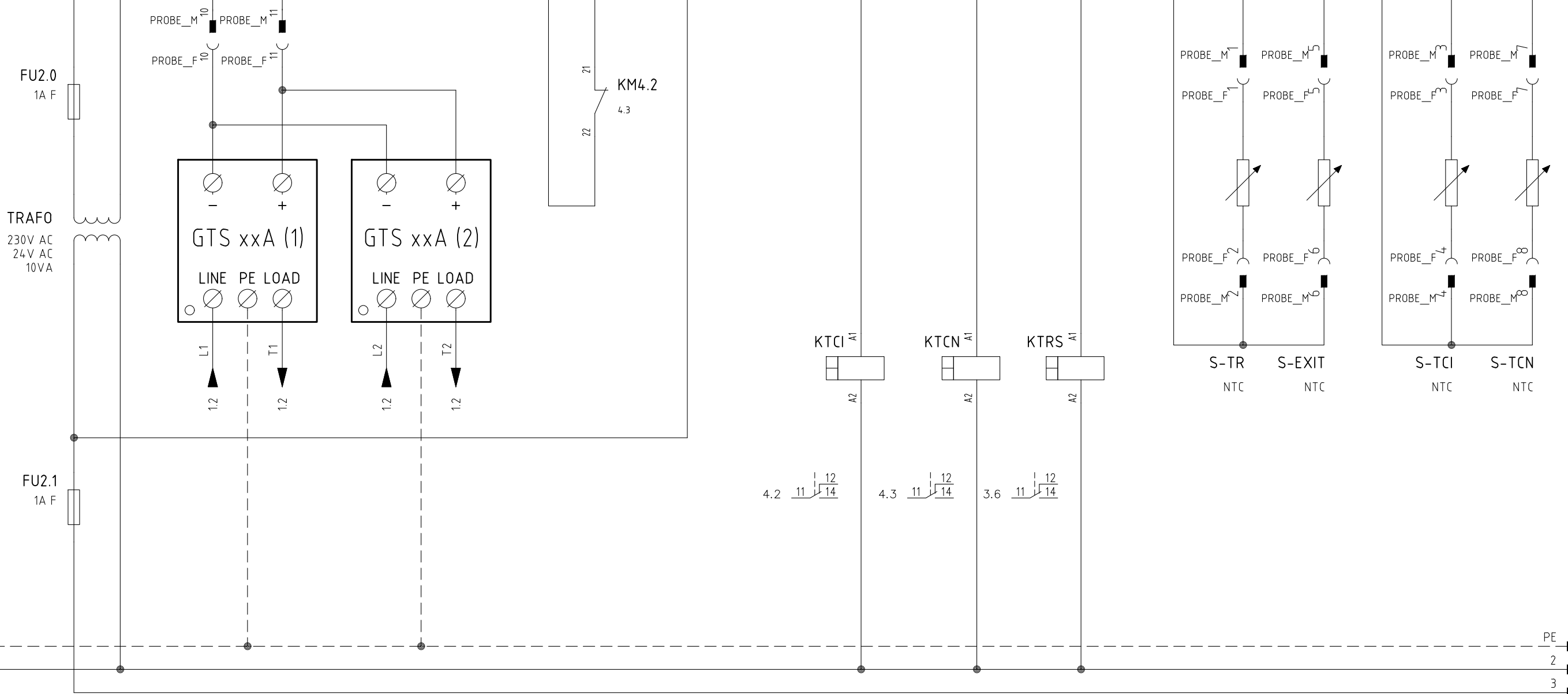
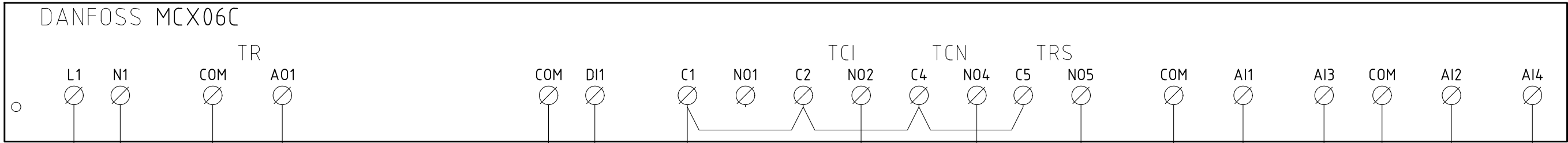

VISTA LATO COMPONENTI (SONDE)  
COMPONENTS SIDE VIEW (PROBE)

Data	12/07/2013	PREC.	FOGLIO
Revisione	01	1	2
Dis. N.	05 - 1001	SEGUE	TOTALE
		3	11

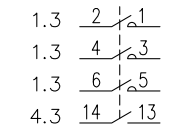
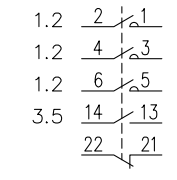
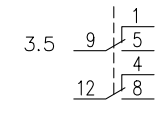
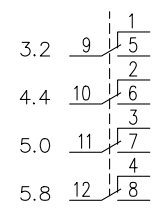
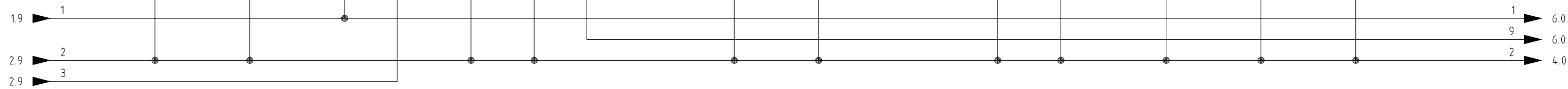
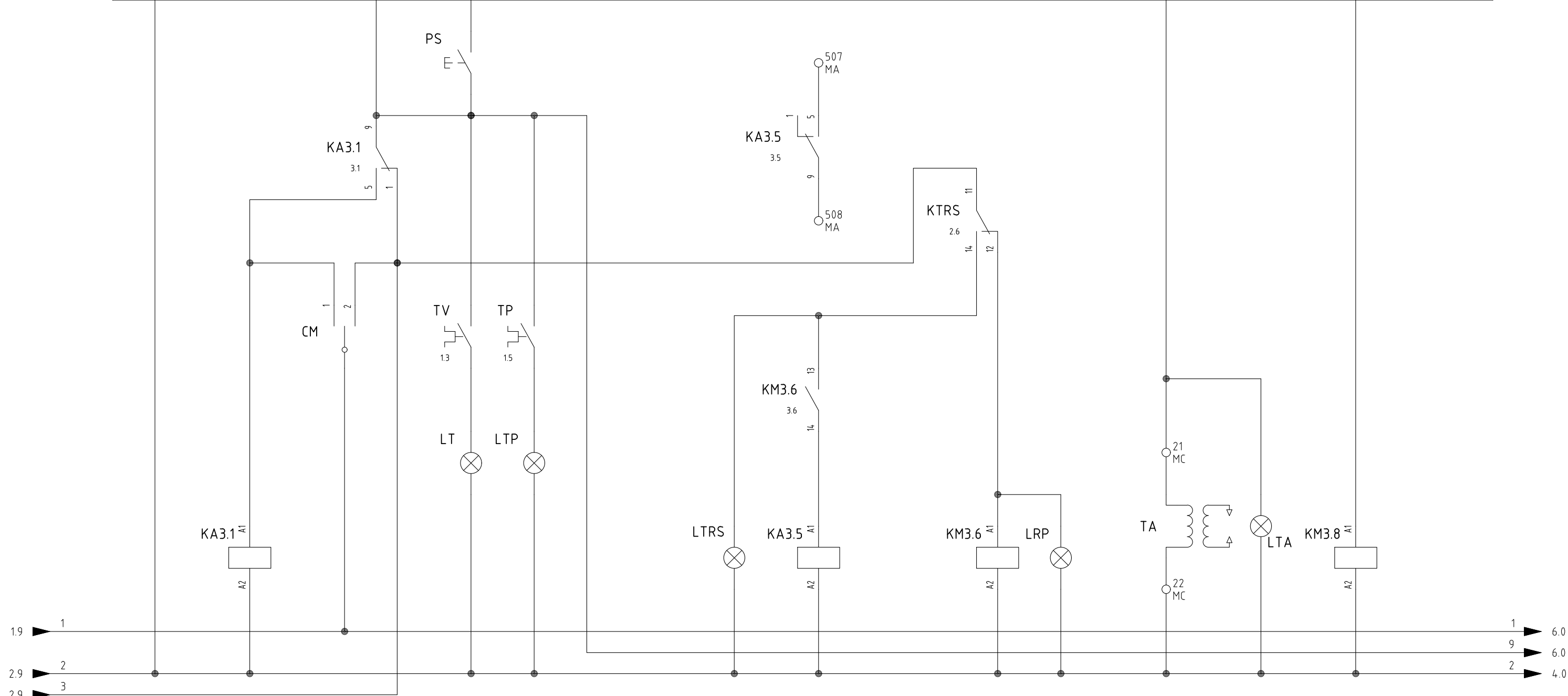
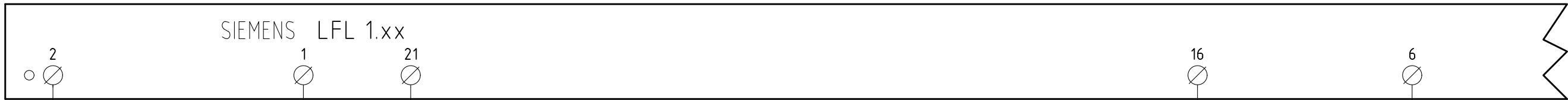

Data	12/07/2013	PREC.	FOGLIO
Revisione	01	2	3
Dis. N.	05 - 1001	SEGUE	TOTALE
		4	11

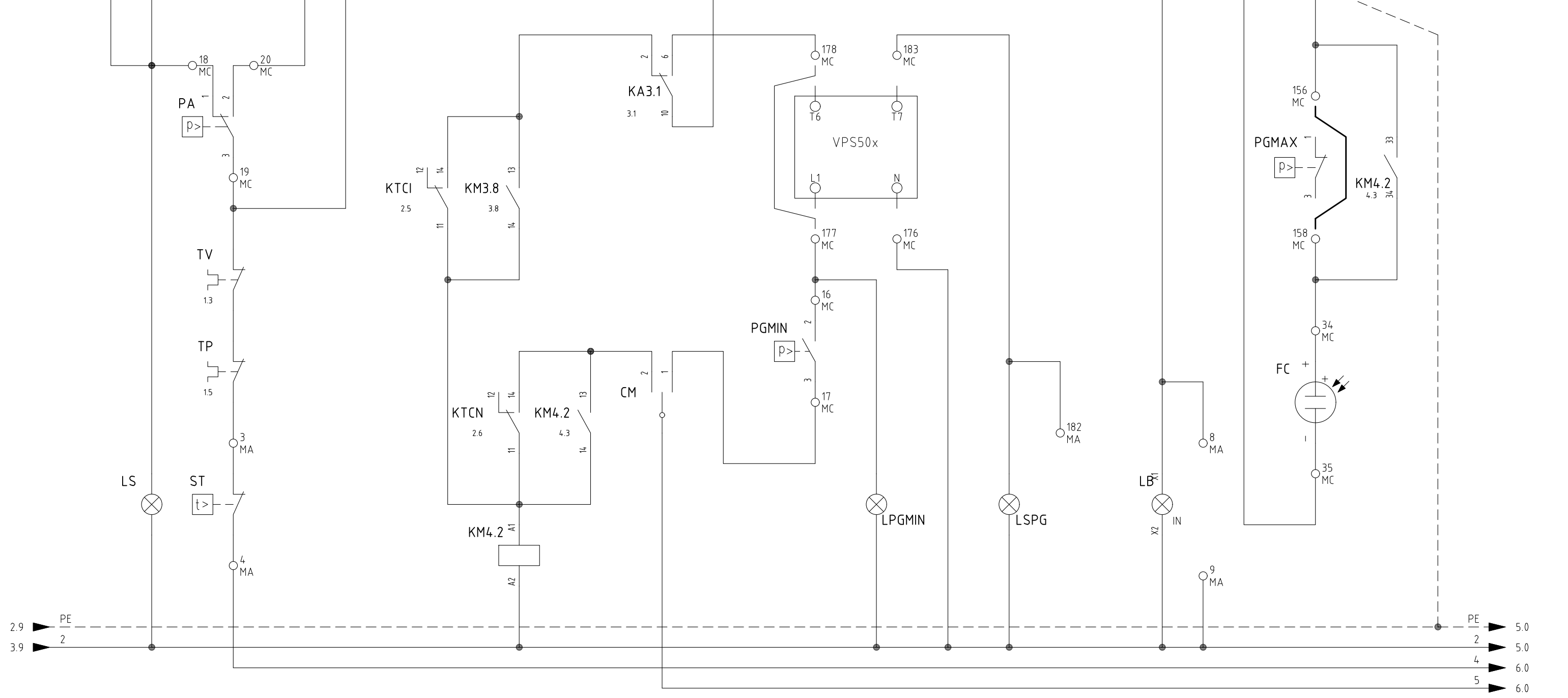
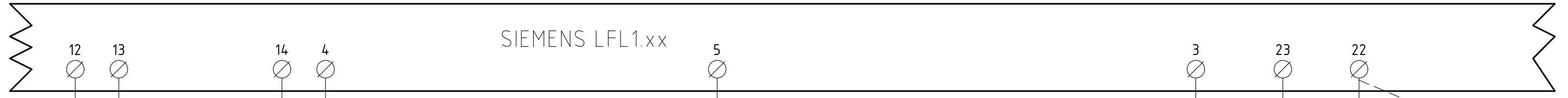

- 1.5 2 1
- 1.5 4 3
- 1.5 6 5
- 4.3 14 13
- 4.8 34 33
- 2.3 22 21

Data	12/07/2013	PREC.	FOGLIO
Revisione	01	3	4
Dis. N.	05 - 1001	SEGUE	TOTALE
		5	11

SIEMENS LFL1.xx

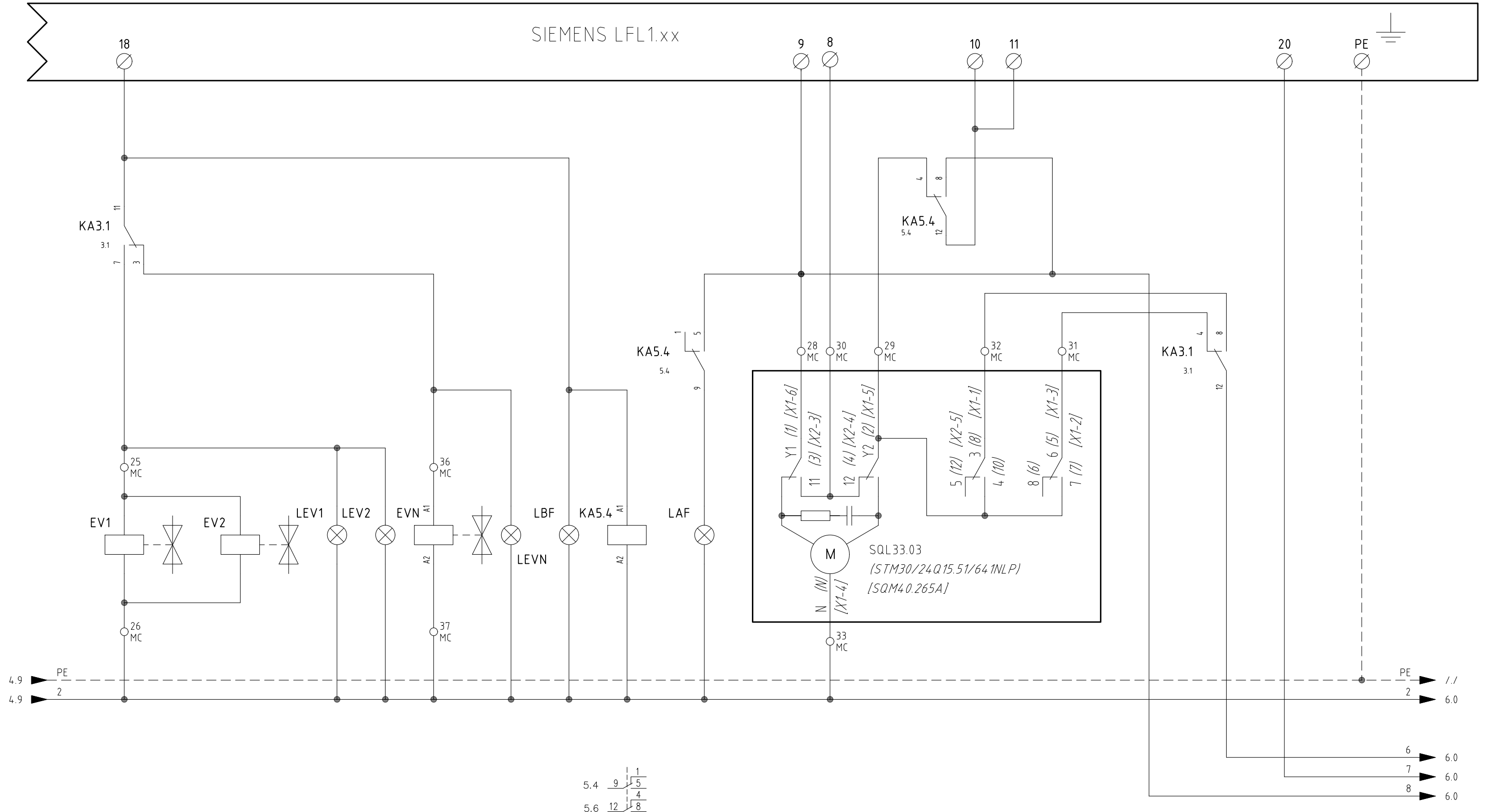

Data	12/07/2013	PREC.	FOGLIO
Revisione	01	4	5
Dis. N.	05 - 1001	SEGUE	TOTALE
		6	11

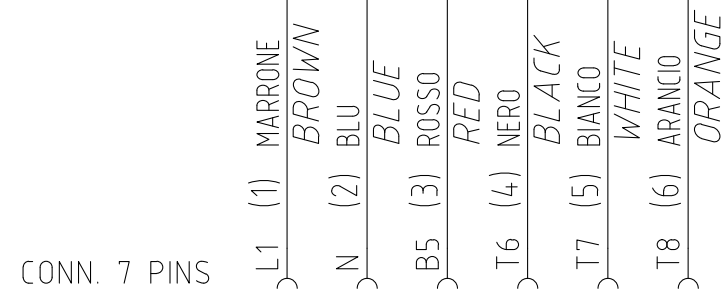
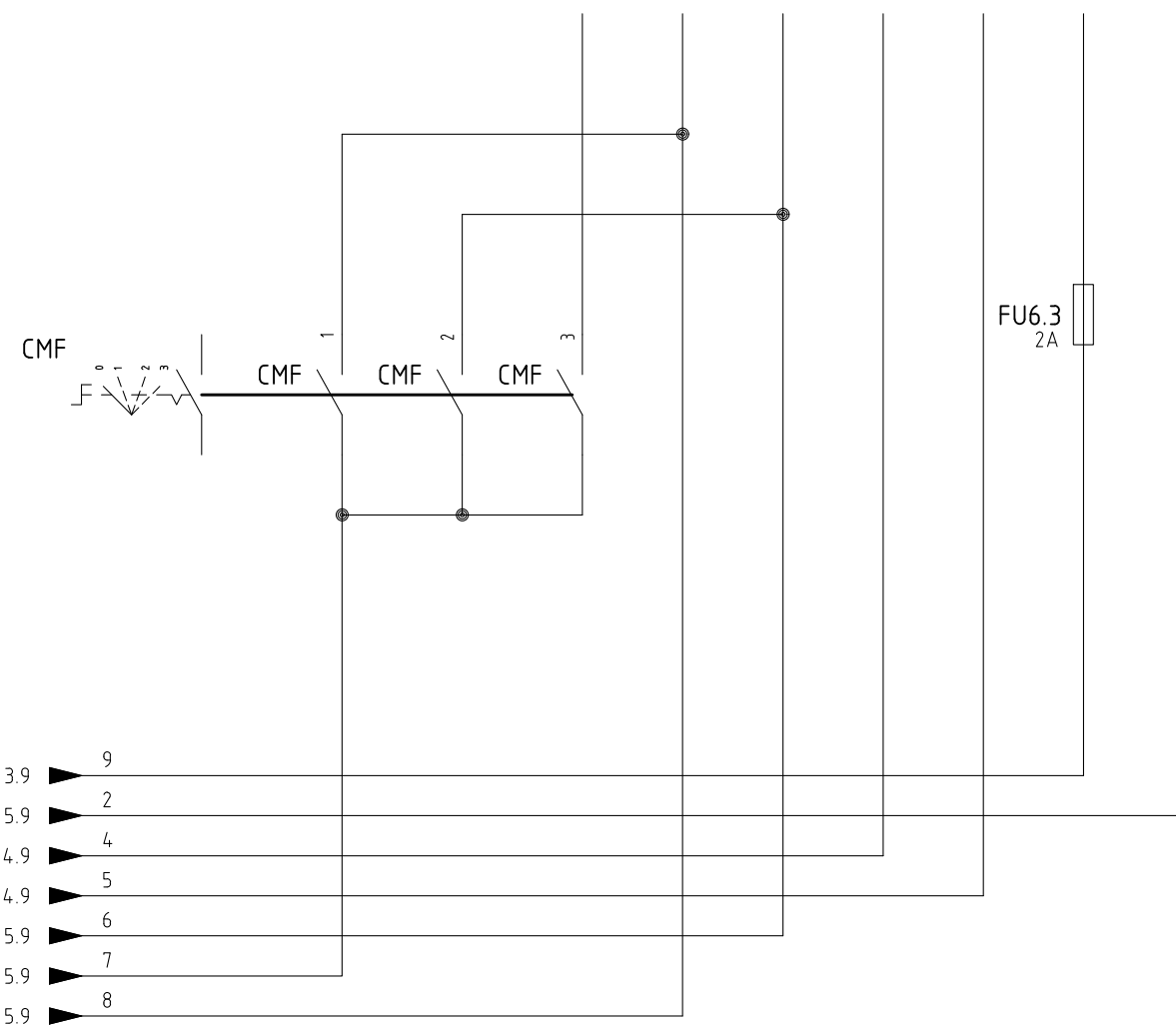
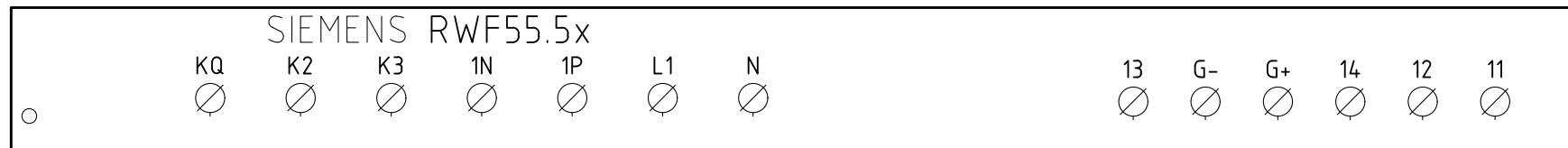
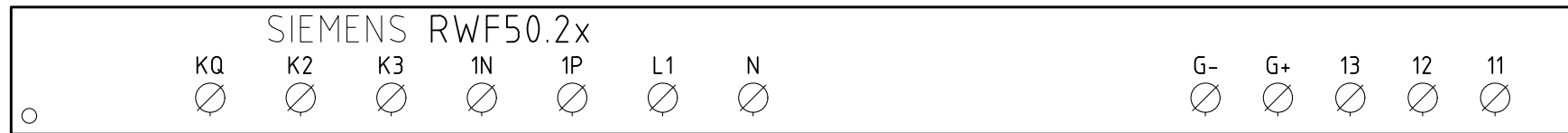
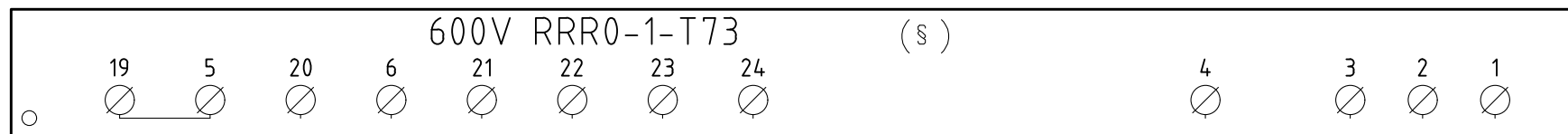
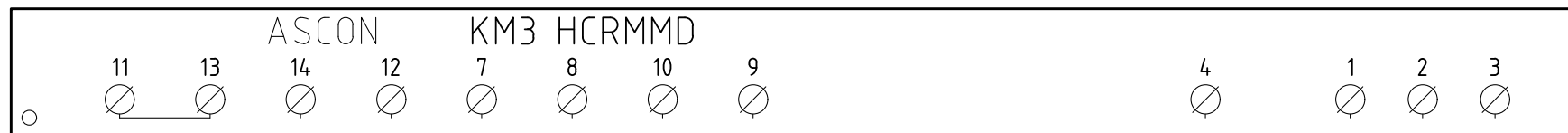

(xx)  
ATTENZIONE COLLEGAMENTO SONDE CON CONNETTORE 7 POLI  
WARNING PROBE CONNECTION WITH 7 PINS CONNECTOR

CAVO 7x0,75mmq  
7x0,75mmq CABLE

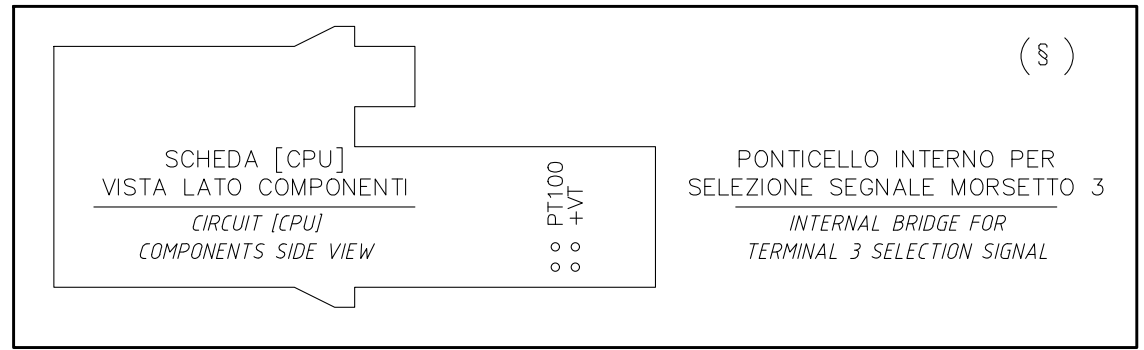

§  
VERSIONE (PR) / VERSIONE (MD) CON RWF.. / 600V / KM3  
(PR) VERSION / (MD) VERSION WITH RWF.. / 600V / KM3

Data	12/07/2013	PREC.	FOGLIO
Revisione	01	5	6
Dis. N.	05 - 1001	SEGUE	TOTALE
		7	11

(xx)

ATTENZIONE COLLEGAMENTO SONDE CON CONNETTORE 7 POLI  
 WARNING PROBE CONNECTION WITH 7 PINS CONNECTOR

### KM3 HCRMMD

### 600V RRR0-1-T73

### RWF55.5x

### RWF50.2x

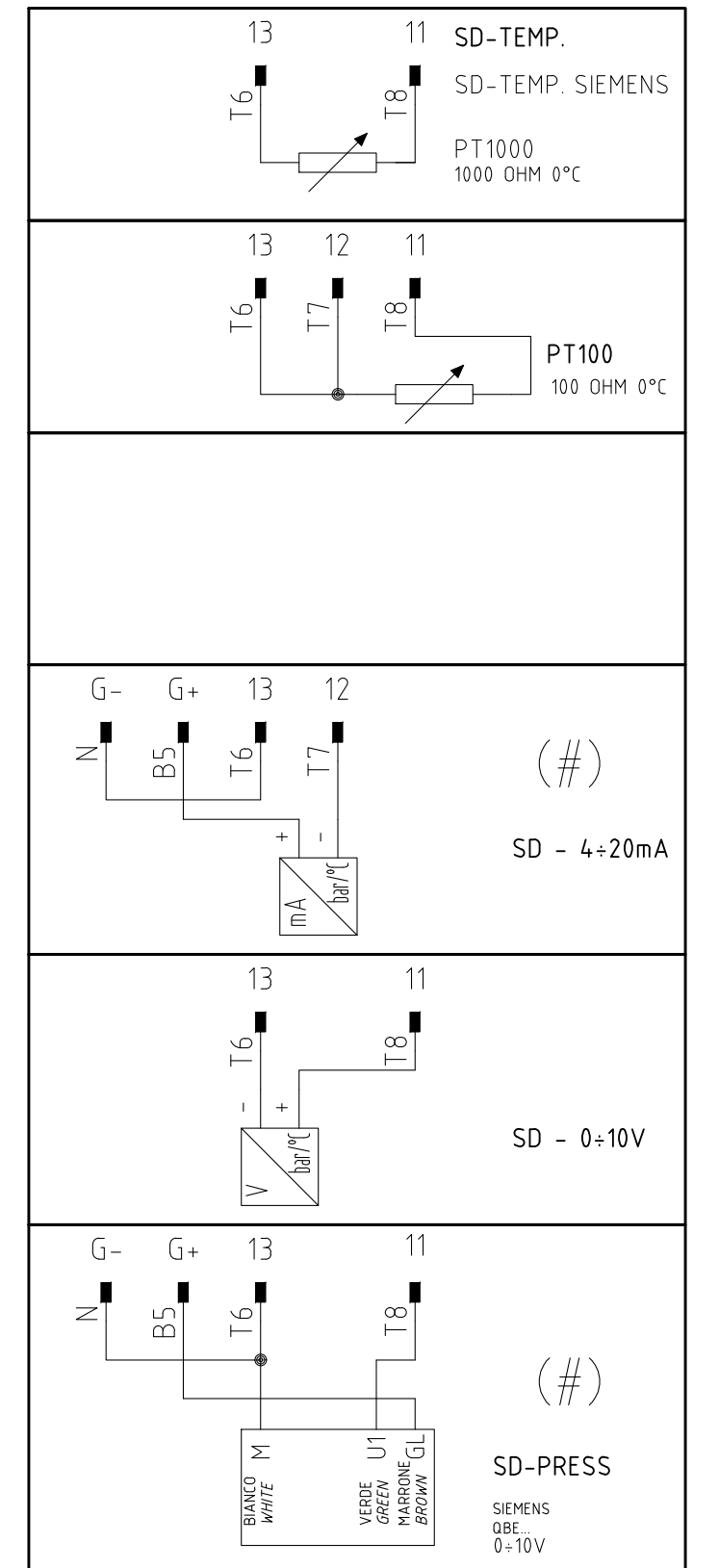
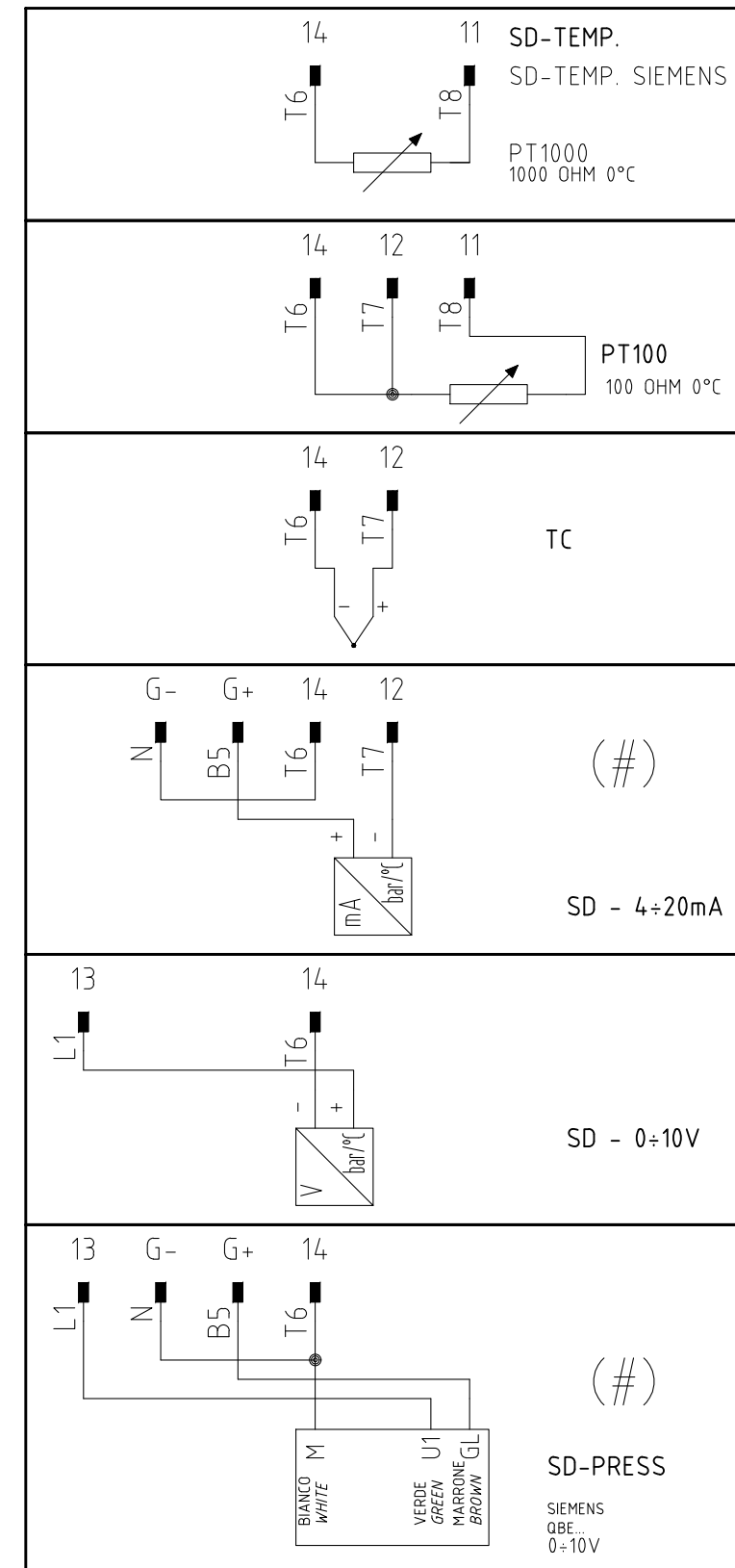
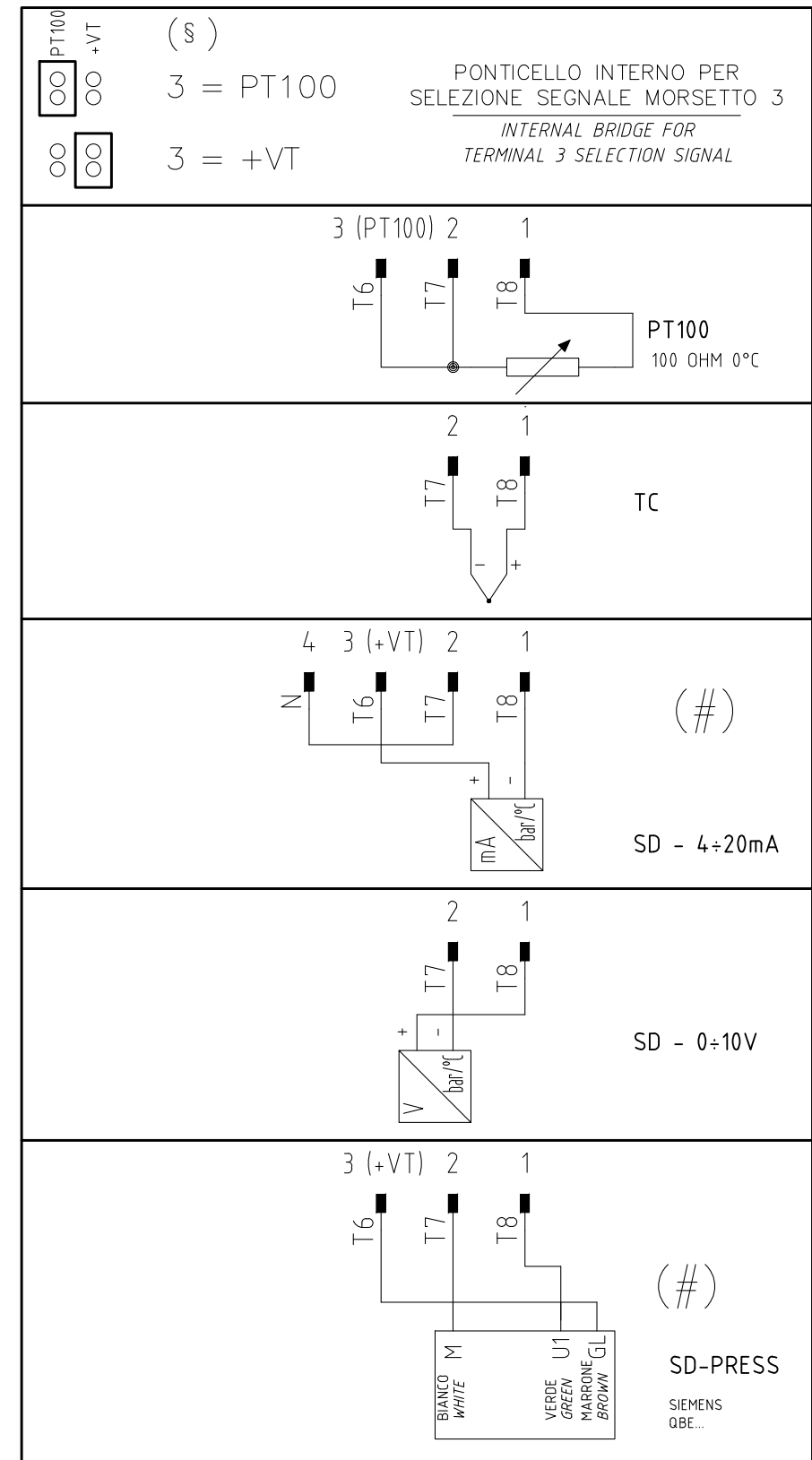
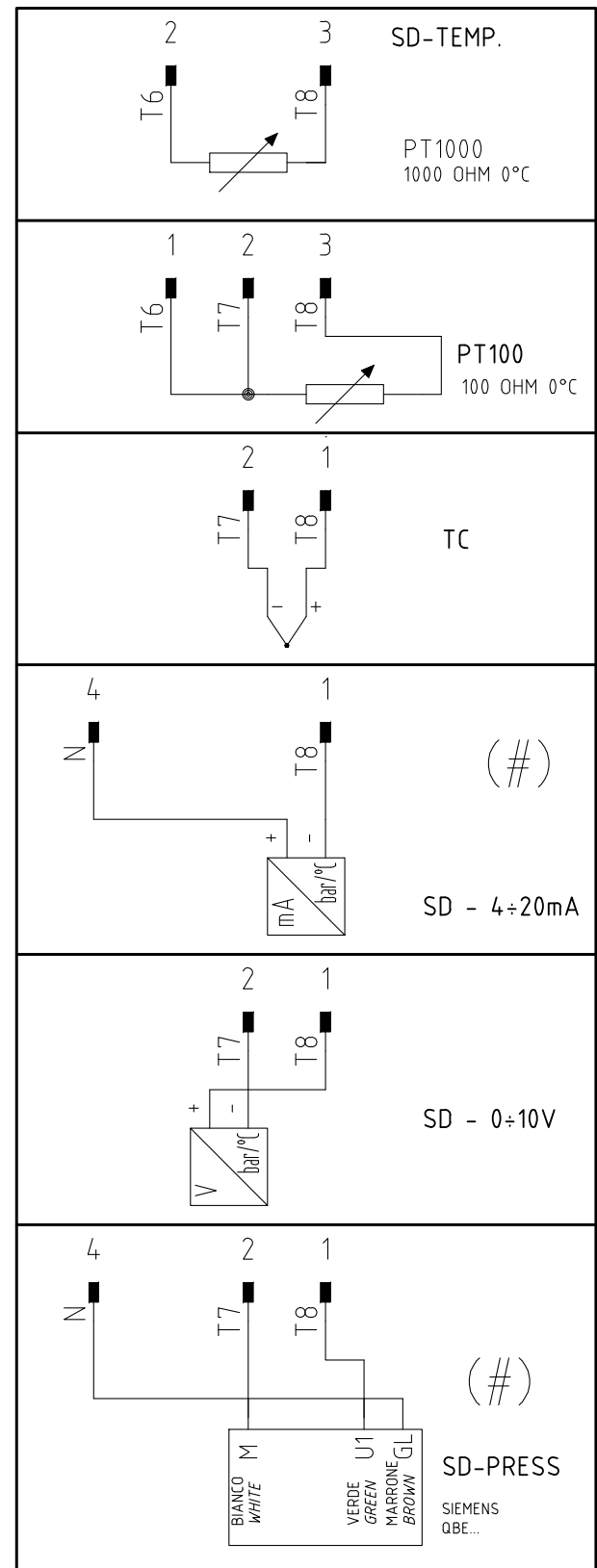

(#)  
 COLLEGAMENTO SOLO PER  
 TRASDUTTORI PASSIVI  
 TRASDUCER PASSIVE  
 CONNECTION ONLY

Data	12/07/2013	PREC.	FOGLIO
Revisione	01	6	7
Dis. N.	05 - 1001	SEGUE	TOTALE
		8	11

**QUADRO QG - MORSETTIERA MA**  
 MORSETTIERA ALIMENTAZIONE BRUCIATORE  
 BURNER SUPPLY TERMINAL BOARD

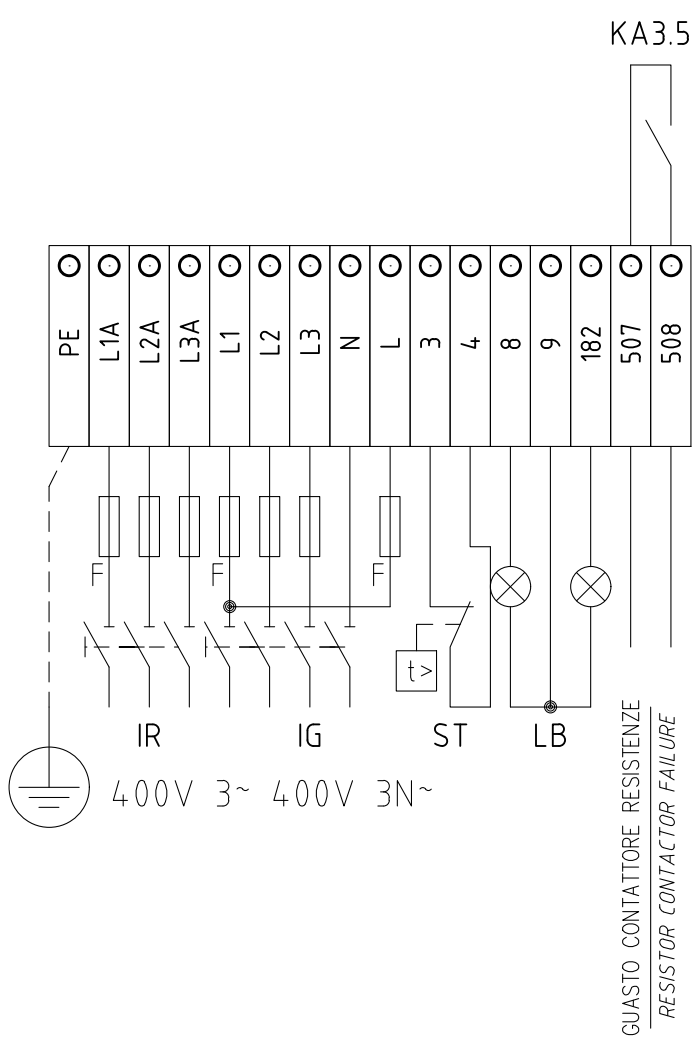

(x)  
 INSTALLATO SOLO SU ALCUNE VERSIONI  
 INSTALLED ON ANY VERSIONS ONLY

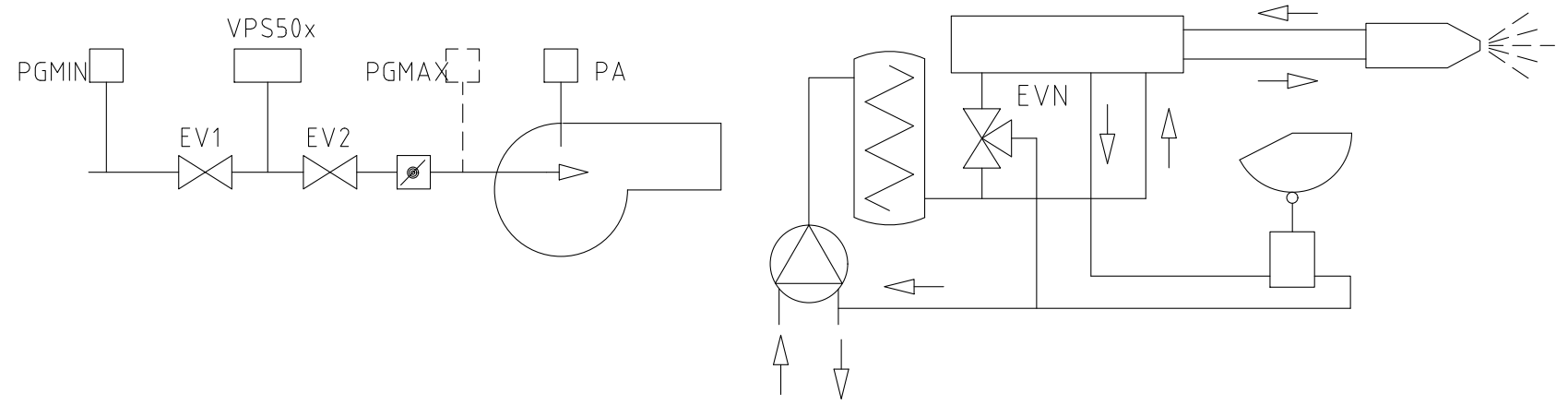

Data	12/07/2013	PREC.	FOGLIO
Revisione	01	7	8
Dis. N.	05 - 1001	SEGUE	TOTALE
		9	11



QUADRO QG - MORSETTIERA MC  
MORSETTIERA COMPONENTI BRUCIATORE  
BURNER COMPONENT TERMINAL BOARD

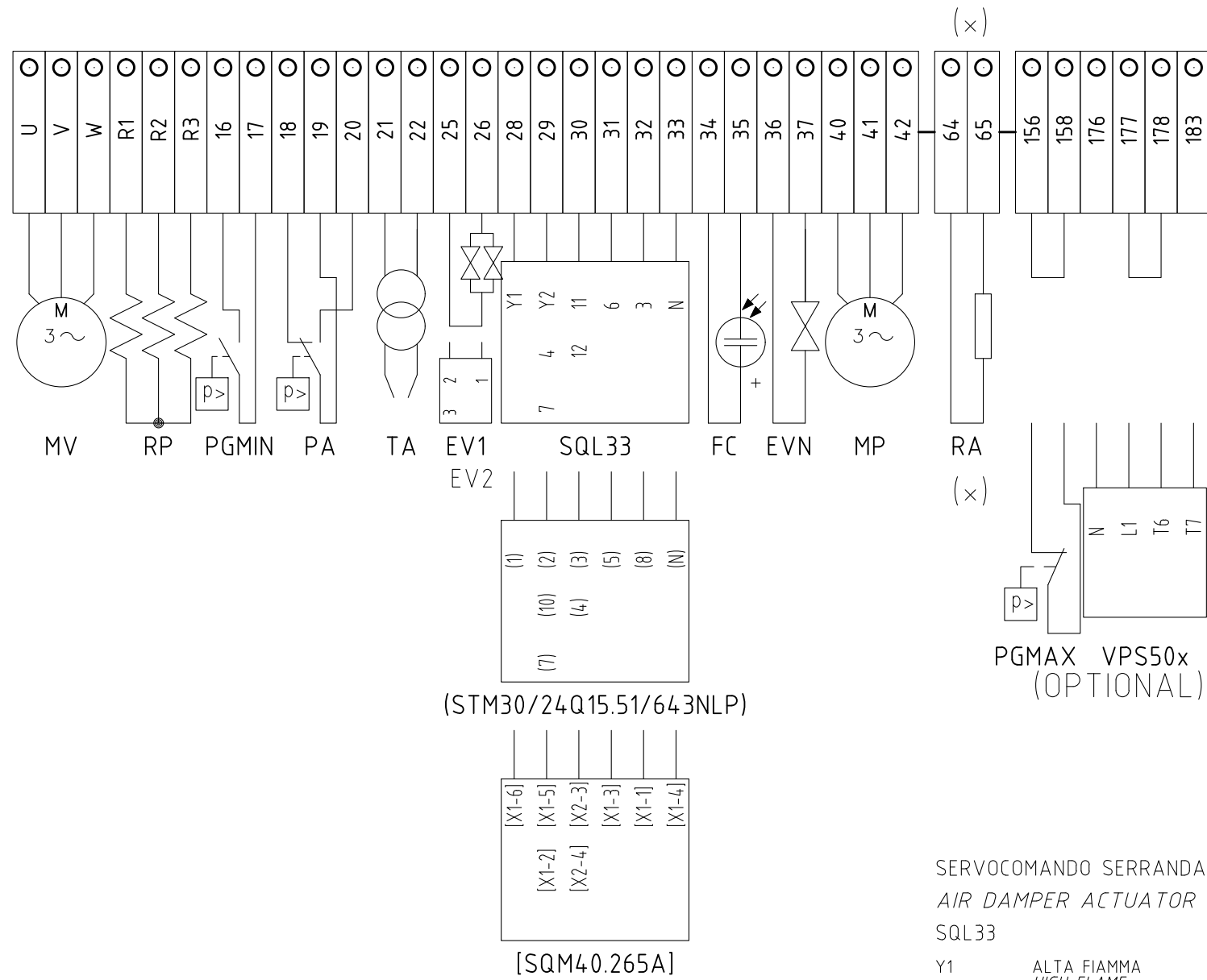

(STM30/24Q15.51/643NLP)

[SQM40.265A]

SERVOCOMANDO SERRANDA ARIA  
AIR DAMPER ACTUATOR  
SQL33

- Y1 ALTA FIAMMA  
HIGH FLAME
- Y2 SOSTA E ACCENSIONE  
STAND-BY AND IGNITION
- 3 BASSA FIAMMA GAS  
GAS LOW FLAME
- 6 BASSA FIAMMA NAFTA  
OIL LOW FLAME

SERVOCOMANDO SERRANDA ARIA (ALTERNATIVO)  
AIR DAMPER ACTUATOR (ALTERNATIVE)  
(STM30/24Q15.51/641NLP)

- I ALTA FIAMMA  
HIGH FLAME
- II SOSTA E ACCENSIONE  
STAND-BY AND IGNITION
- III BASSA FIAMMA GAS  
GAS LOW FLAME
- V BASSA FIAMMA NAFTA  
OIL LOW FLAME

QG - PROBE\_F  
CONNETTORE SONDE [MCX06C]  
[MCX06C] PROBES CONNECTOR

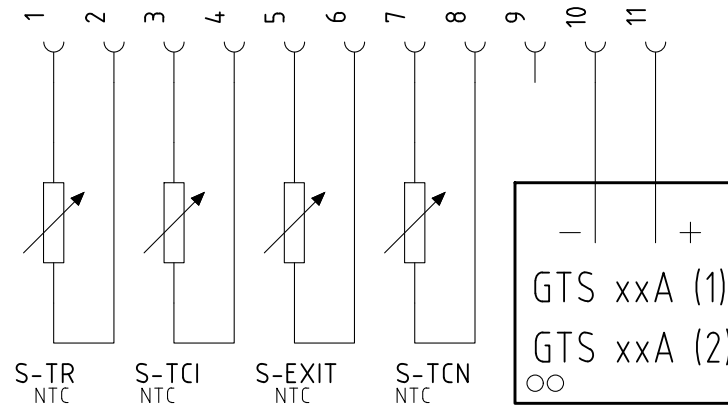

SERVOCOMANDO SERRANDA ARIA (ALTERNATIVO)  
AIR DAMPER ACTUATOR (ALTERNATIVE)  
[SQM40.265A]

- I ALTA FIAMMA  
HIGH FLAME
- II SOSTA E ACCENSIONE  
STAND-BY AND IGNITION
- III BASSA FIAMMA GAS  
GAS LOW FLAME
- IV BASSA FIAMMA NAFTA  
OIL LOW FLAME

(x)

INSTALLATO SOLO SU ALCUNE VERSIONI  
INSTALLED ON ANY VERSIONS ONLY

Data	12/07/2013	PREC.	FOGLIO
Revisione	01	8	9
Dis. N.	05 - 1001	SEGUE	TOTALE
		10	11

Sigla/Item	Foglio/Sheet	Funzione	Function
600V RRR0-1-T73	6	REGOLATORE MODULANTE (ALTERNATIVO)	BURNER MODULATOR (ALTERNATIVE)
(STM30/24Q15.51/641NLP)	5	SERVOCOMANDO SERRANDA ARIA (ALTERNATIVO)	AIR DAMPER ACTUATOR (ALTERNATIVE)
CM	1	COMMUTATORE FUNZIONAMENTO 1)GAS 0)SPENTO 2)NAFTA	MANUAL OPERATION SWITCH 1)GAS 0)SPENTO 2)OIL
CMF	6	COMMUT. MANUALE FUNZ. 0)FERMO 1)ALTA FIAMMA 2)BASSA FIAMMA 3)AUTOMATICO	MANUAL SWITCH 0)OFF 1)HIGH FLAME 2)LOW FLAME 3)AUTOMATIC
EV1	5	ELETTRIVALVOLA GAS LATO RETE (0 GRUPPO VALVOLE)	UPSTREAM GAS SOLENOID VALVE (OR VALVES GROUP)
EV2	5	ELETTRIVALVOLA GAS LATO BRUCIATORE (0 GRUPPO VALVOLE)	DOWNSTREAM GAS SOLENOID VALVE (OR VALVES GROUP)
EVN	5	ELETTRIVALVOLA NAFTA	OIL SOLENOID VALVE
FC	4	SONDA UV RILEVAZIONE FIAMMA	UV FLAME DETECTOR
(x) FU1.1	1	FUSIBILE RESISTENZE AUSILIARIE	AUXILIARY HEATERS FUSE
FU1.2	1	FUSIBILI DI LINEA	LINE FUSES
FU1.3	1	FUSIBILI DI LINEA	LINE FUSES
FU1.4	1	FUSIBILE DI LINEA	LINE FUSE
FU1.5	1	FUSIBILI LINEA POMPA	PUMP LINE FUSES
FU2.0	2	FUSIBILE AUSILIARIO	AUXILIARY FUSE
FU2.1	2	FUSIBILE AUSILIARIO	AUXILIARY FUSE
FU6.3	6	FUSIBILE	FUSE
GTS xxA (1)	2	TIRISTORE	THYRISTOR
GTS xxA (2)	2	TIRISTORE	THYRISTOR
IG	1	INTERRUTTORE GENERALE	MAINS SWITCH
(x) IR	1	INTERRUTTORE LINEA RESISTENZE PRERISCALDATORE	PRE-HEATING RESISTOR LINE SWITCH
IRA	1	INTERRUTTORE RESISTENZE AUSILIARIE	AUXILIARY HEATERS SWITCH
KA3.1	3	RELE" AUSILIARIO	AUXILIARY RELAY
KA3.5	3	RELE" AUSILIARIO SEGNALAZIONE GUASTO CONTATTORE RESISTENZE	AUXILIARY RELAY FOR RESISTOR CONTACTOR FAILURE
KA5.4	5	RELE" AUSILIARIO	AUXILIARY RELAY
KM3.6	3	CONTATTORE RESISTENZE PRERISCALDATORE [RP]	PRE-HEATING RESISTOR [RP] CONTACTOR
KM3.8	3	CONTATTORE MOTORE VENTILATORE	FAN MOTOR CONTACTOR
KM3 HCRMMD	6	REGOLATORE MODULANTE (ALTERNATIVO)	BURNER MODULATOR (ALTERNATIVE)
KM4.2	4	CONTATTORE MOTORE POMPA NAFTA	OIL PUMP MOTOR CONTACTOR
KTCI	2	RELE" AUSILIARIO	AUXILIARY RELAY
KTCN	2	RELE" AUSILIARIO	AUXILIARY RELAY
KTRS	2	RELE" AUSILIARIO	AUXILIARY RELAY
LAF	5	LAMPADA SEGNALAZIONE ALTA FIAMMA BRUCIATORE	BURNER IN HIGH FLAME INDICATOR LIGHT
LB	4	LAMPADA SEGNALAZIONE BLOCCO BRUCIATORE	INDICATOR LIGHT FOR BURNER LOCK-OUT
LBF	5	LAMPADA SEGNALAZIONE BASSA FIAMMA BRUCIATORE	BURNER IN LOW FLAME INDICATOR LIGHT
LEV1	5	LAMPADA SEGNALAZIONE APERTURA [EV1]	INDICATOR LIGHT FOR OPENING OF ELECTRO-VALVE [EV1]
LEV2	5	LAMPADA SEGNALAZIONE APERTURA [EV2]	INDICATOR LIGHT FOR OPENING OF ELECTRO-VALVE [EV2]
LEVN	5	LAMPADA SEGNALAZIONE APERTURA [EVN]	INDICATOR LIGHT FOR OPENING OF ELECTRO-VALVE [EVN]
LFL 1.xx	3	APPARECCHIATURA CONTROLLO FIAMMA	CONTROL BOX

(x)  
 INSTALLATO SOLO SU ALCUNE VERSIONI  
 INSTALLED ON ANY VERSIONS ONLY

Data	12/07/2013	PREC.	FOGLIO
Revisione	01	9	10
Dis. N.	05 - 1001	SEGUE	TOTALE
		11	11

Sigla/Item	Foglio/Sheet	Funzione	Function
LPGMIN	4	LAMPADA SEGNALAZIONE PRESENZA GAS IN RETE	INDICATOR LIGHT FOR PRESENCE OF GAS IN THE NETWORK
LRP	3	LAMPADA SEGNALAZIONE FUNZIONAMENTO PRERISCALDATORE [RP]	INDICATOR LIGHT FOR PRE-HEATING RESISTOR [RP] OPERATION
LS	4	LAMPADA SEGNALAZIONE SOSTA BRUCIATORE	INDICATOR LIGHT FOR BURNER STAND-BY
LSPG	4	LAMPADA SEGNALAZIONE BLOCCO CONTROLLO TENUTA VALVOLE	INDICATOR LIGHT FOR LEAKAGE OF VALVES
LT	3	LAMPADA SEGNALAZIONE BLOCCO TERMICO MOTORE VENTILATORE	INDICATOR LIGHT FOR FAN MOTOR OVERLOAD THERMAL CUTOUT
LTA	3	LAMPADA SEGNALAZIONE TRASFORMATORE DI ACCENSIONE	IGNITION TRANSFORMER INDICATOR LIGHT
LTP	3	LAMPADA SEGNALAZIONE BLOCCO TERMICO MOTORE POMPA	INDICATOR LIGHT FOR PUMP MOTOR OVERLOAD THERMAL CUTOUT
LTRS	3	LAMPADA SEGNALAZIONE BLOCCO TERMOSTATO DI SICUREZZA [TRS]	INDICATOR LIGHT FOR [TRS] SAFETY THERMOSTAT
MCX06C	2	REGOLATORE TEMPERATURE NAFTA	OIL TEMPERATURE REGULATOR
MP	1	MOTORE POMPA NAFTA	OIL PUMP MOTOR
MV	1	MOTORE VENTILATORE	FAN MOTOR
PA	4	PRESSOSTATO ARIA	AIR PRESSURE SWITCH
PGMAX	4	PRESSOSTATO GAS DI MASSIMA PRESSIONE (OPTIONAL)	MAXIMUM PRESSURE GAS SWITCH (OPTIONAL)
PGMIN	4	PRESSOSTATO GAS DI MINIMA PRESSIONE	MINIMUM GAS PRESSURE SWITCH
PS	3	PULSANTE SBLOCCO FIAMMA	FLAME UNLOCK BUTTON
PT100	7	SONDA DI TEMPERATURA	TEMPERATURE PROBE
(x) RA	1	RESISTENZE AUSILIARIE	AUXILIARY HEATERS
RP	1	RESISTENZE PRERISCALDATORE NAFTA	PRE-HEATING TANK RESISTORS
RWF50.2x	6	REGOLATORE MODULANTE	BURNER MODULATOR
RWF55.5x	6	REGOLATORE MODULANTE (ALTERNATIVO)	BURNER MODULATOR (ALTERNATIVE)
S-EXIT	2	SONDA TEMPERATURA USCITA BARILOTTO	TANK OUTLET OIL TEMPERATURE PROBE
S-TCI	2	SONDA TEMPERATURA CONSENSO IMPIANTO	PLANT CONSENT TEMPERATURE PROBE
S-TCN	2	SONDA TEMPERATURA CONSENSO NAFTA	OIL CONSENT TEMPERATURE PROBE
S-TR	2	SONDA TEMPERATURA RESISTENZE	RESISTOR TEMPERATURE PROBE
SD-PRESS	7	SONDA DI PRESSIONE	PRESSURE PROBE
SD-TEMP.	7	SONDA DI TEMPERATURA	TEMPERATURE PROBE
SD - 0÷10V	7	TRASDUTTORE USCITA IN TENSIONE	TRANSDUCER VOLTAGE OUTPUT
SD - 4÷20mA	7	TRASDUTTORE USCITA IN CORRENTE	TRANSDUCER CURRENT OUTPUT
SQL33.03	5	SERVOCOMANDO SERRANDA ARIA	AIR DAMPER ACTUATOR
ST	4	SERIE TERMOSTATI/PRESSOSTATI	SERIES OF THERMOSTATS OR PRESSURE SWITCHES
TA	3	TRASFORMATORE DI ACCENSIONE	IGNITION TRANSFORMER
TC	7	TERMOCOPPIA	THERMOCOUPLE
TP	1	TERMICO MOTORE POMPA	PUMP MOTOR THERMAL
TRAFO	2	TRASFORMATORE AUSILIARIO	AUXILIARY TRANSFORMER
TV	1	TERMICO MOTORE VENTILATORE	FAN MOTOR THERMAL
VPS50x	4	CONTROLLO DI TENUTA VALVOLE GAS (OPTIONAL)	GAS PROVING SYSTEM (OPTIONAL)
[SQM40.265A]	5	SERVOCOMANDO SERRANDA ARIA (ALTERNATIVO)	AIR DAMPER ACTUATOR (ALTERNATIVE)

(x)  
 INSTALLATO SOLO SU ALCUNE VERSIONI  
 INSTALLED ON ANY VERSIONS ONLY

Data	12/07/2013	PREC.	FOGLIO
Revisione	01	10	11
Dis. N.	05 - 1001	SEGUE	TOTALE
		/	11