

02	PRINTED CIRCUIT 6100561 MODIFIED (REV.1)	01/09/14	U. PINTON
01	MODIFIED PCB COD. 6100561	12/02/14	U. PINTON
REV.	MODIFICA	DATA	FIRME



PLANT
 TIPI/TYPES P61/÷/P75A/LX60/÷/LX75A/R(X)63/÷/R(X)520A
 MODELLO/MODEL M--.PR(MD).x.xx.A.x.xx.EA

DESCRIPTION
 LMV20 + COD. 6100561 CIRCUITO STAMPATO
 LMV20 + COD. 6100561 PRINTED CIRCUIT

Ordine
 Commessa
 Esecutore
 U. PINTON

Data Controllato
 01/09/2014
 Controllato
 E. CAVALLI

Data 22/07/2013
 Revisione 02
 Dis. N. 05-1004 - A

PREC. /
 FOGLIO 1
 SEQUE 2
 TOTALE 11

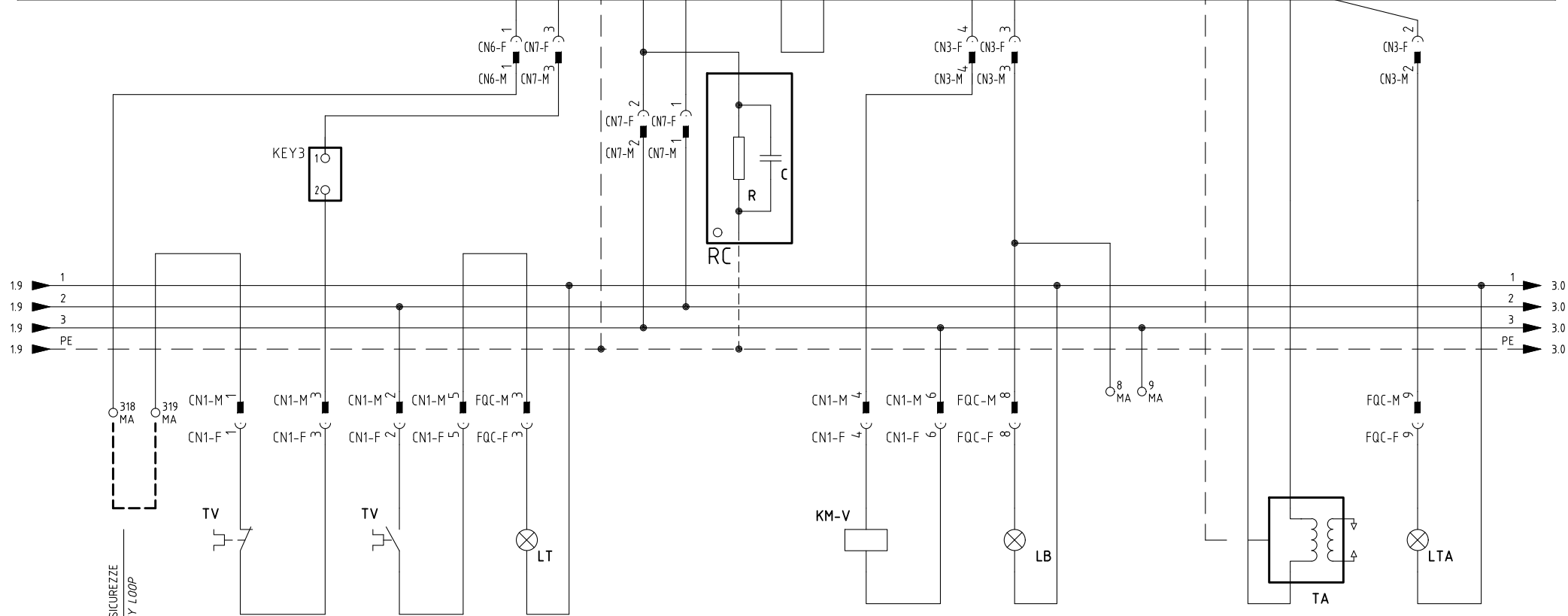
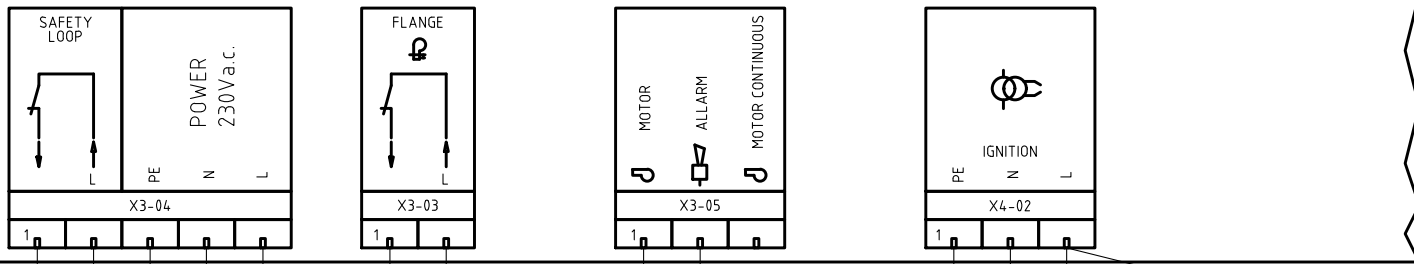

CATENA SICUREZZE
SAFETY LOOP

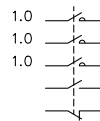

Data	22/07/2013	PREC.	FOGLIO
Revisione	02	1	2
Dis. N.	05-1004 - A	SEGUE	TOTALE
		3	11

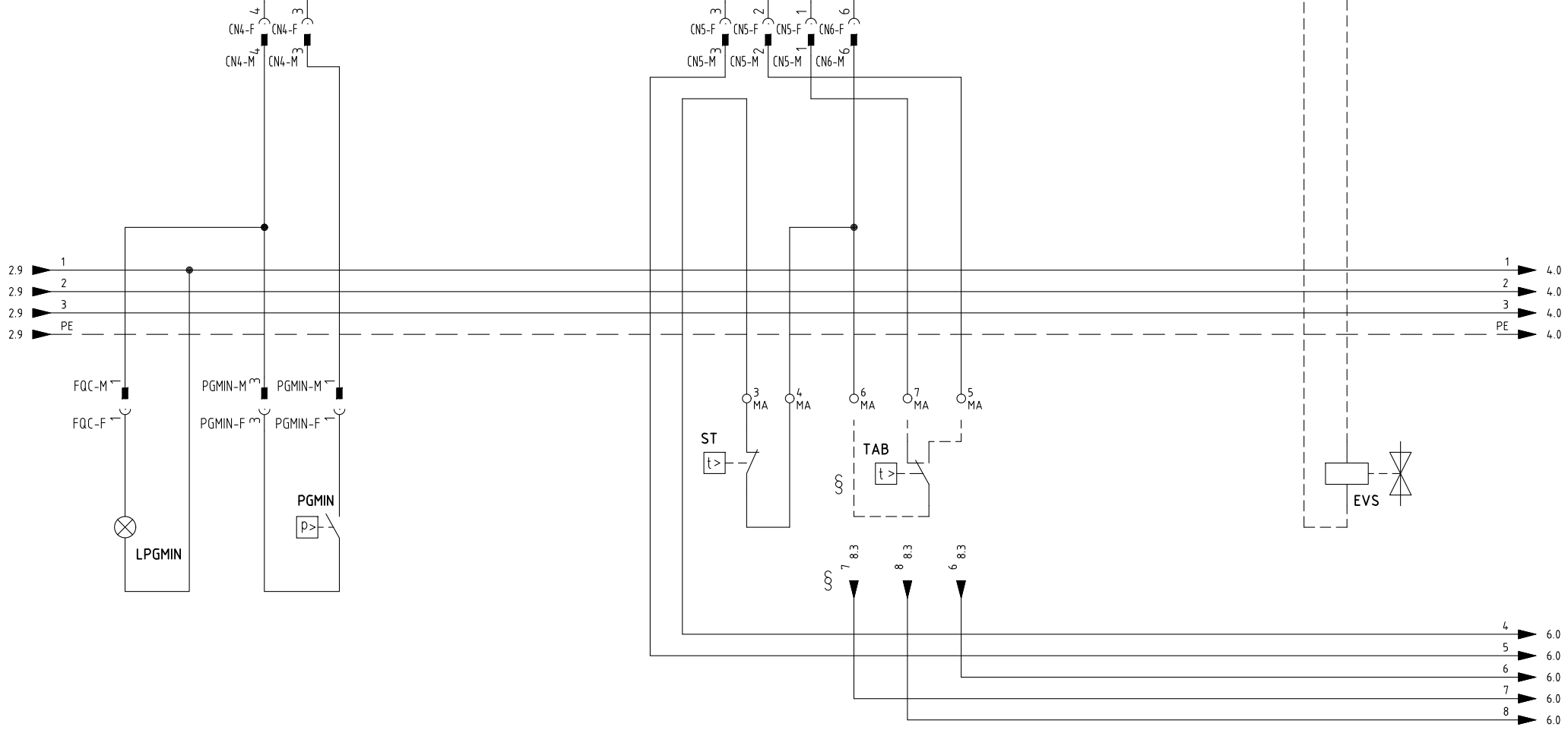
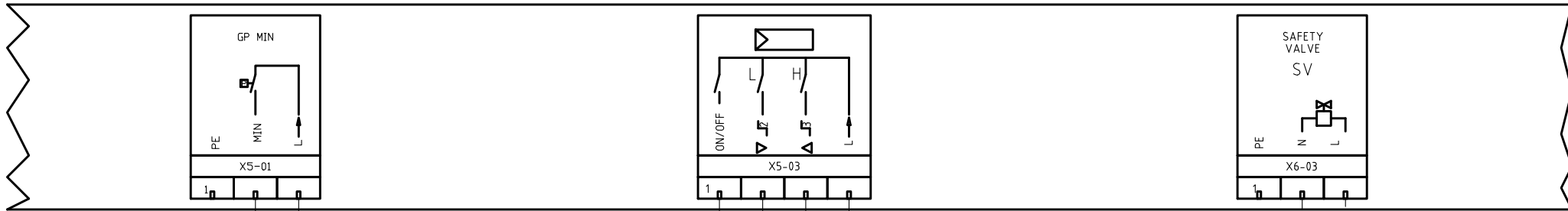

§

VERSIONE (PR) / VERSIONE (MD) CON RWF.. / 600V / KM3
 (PR) VERSION / (MD) VERSION WITH RWF.. / 600V / KM3

Data	22/07/2013	PREC.	FOGLIO
Revisione	02	2	3
Dis. N.	05-1004 - A	SEQUE	TOTALE
		4	11

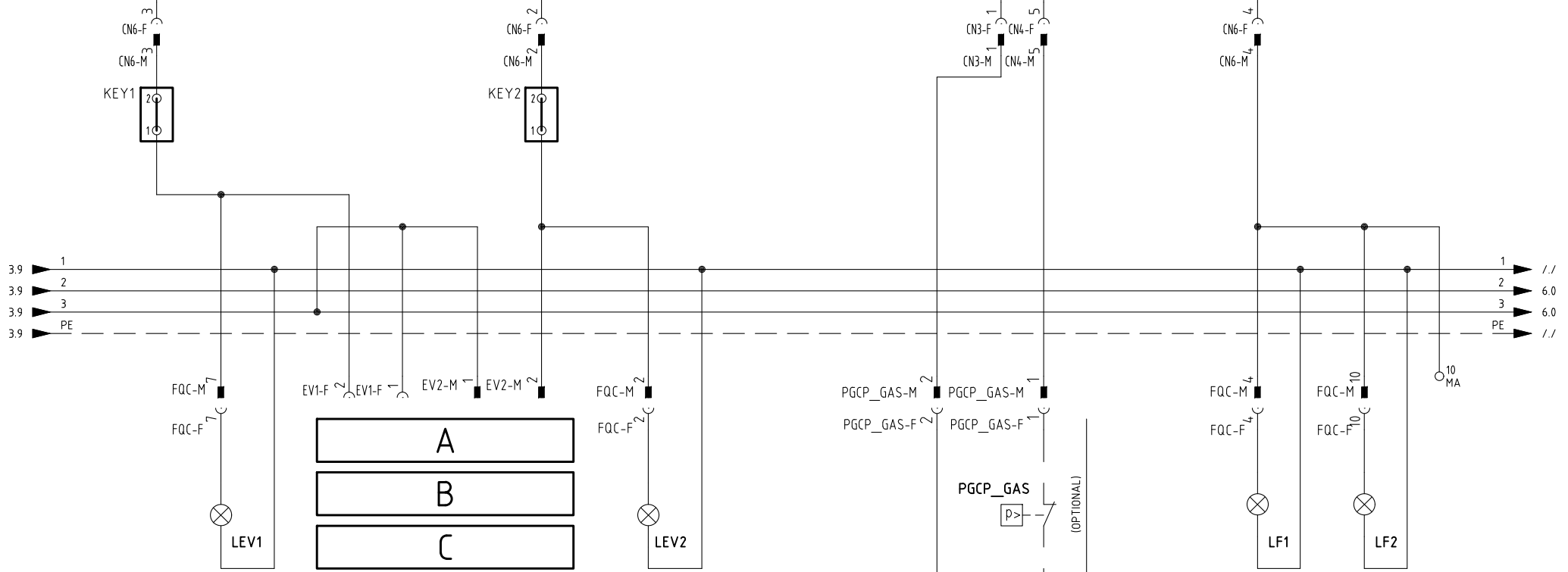
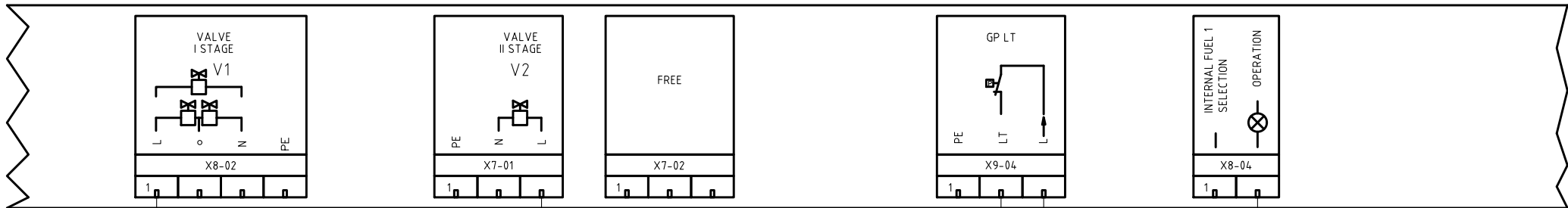

ESECUZIONE [A] = SOLO SENZA CONTROLLO TENUTA
 [A] PERFORMANCE = WITHOUT GAS LEAKAGE ONLY

A

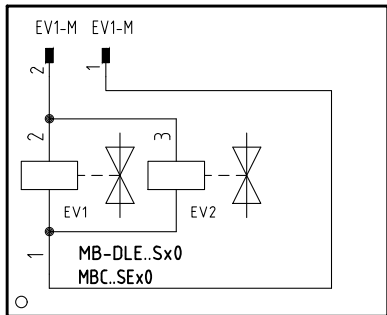

B

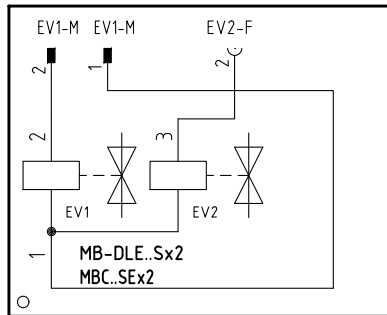

C

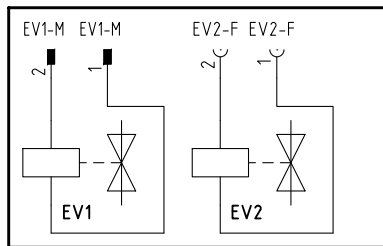

Data	22/07/2013	PREC.	FOGLIO
Revisione	02	3	4
Dis. N.	05-1004 - A	SEGUE	TOTALE
		5	11

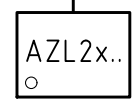
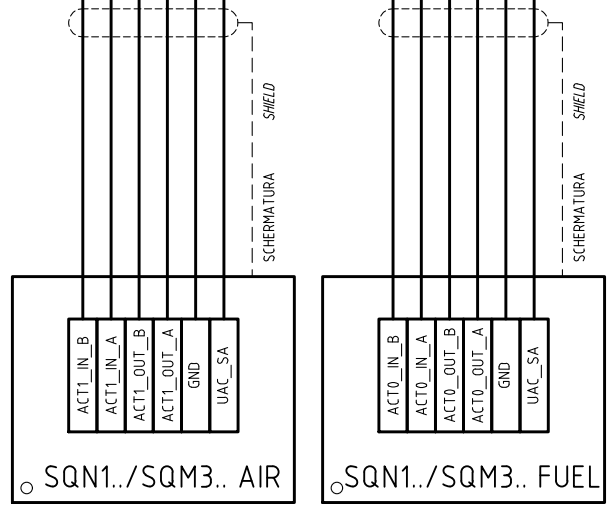
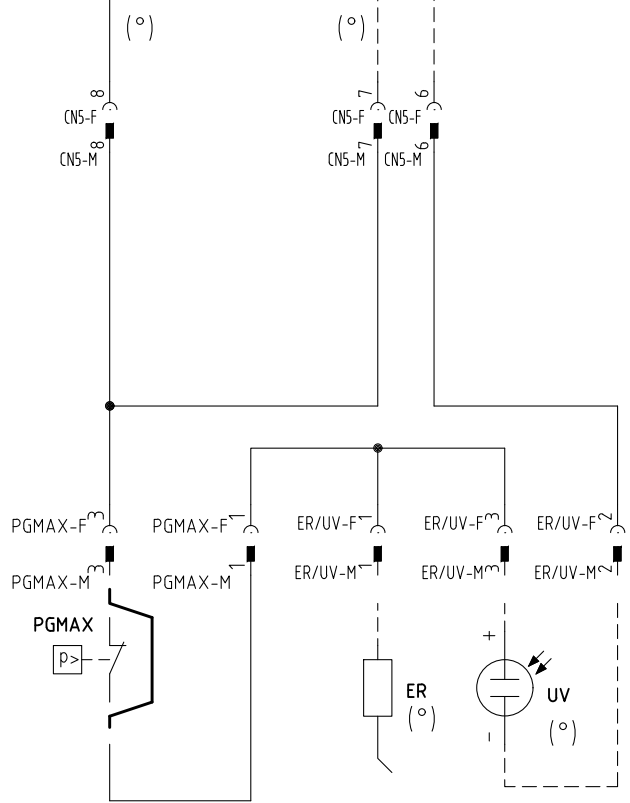
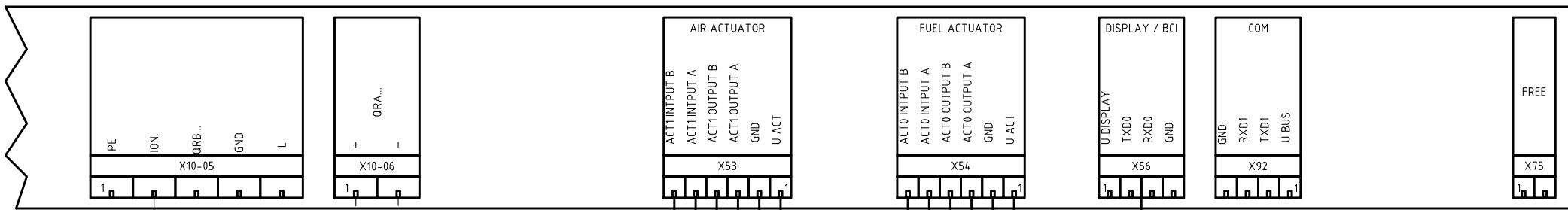

(°)
 SONDA "UV" IN ALTERNATIVA A ELETTRODO "ER"
 "UV" PROBE ALTERNATIVE TO "ER"

Data	22/07/2013	PREC.	FOGLIO
Revisione	02	4	5
Dis. N.	05-1004 - A	SEGUE	TOTALE
		6	11

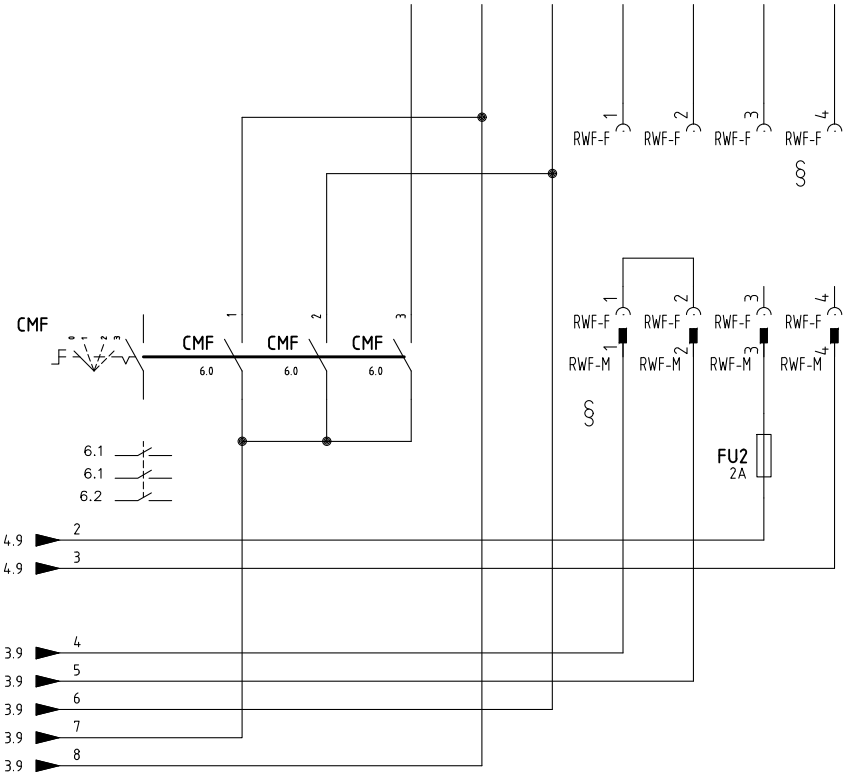
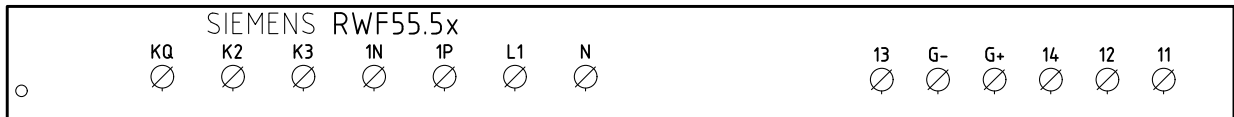
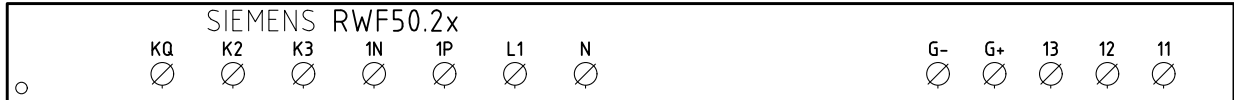
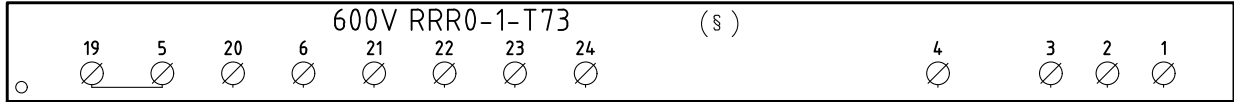
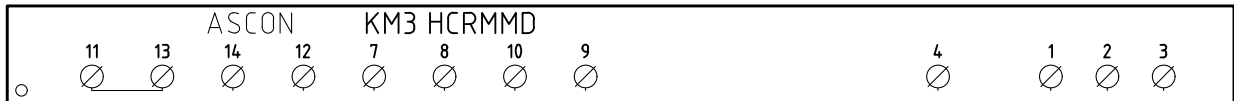

CONN. 7 PINS

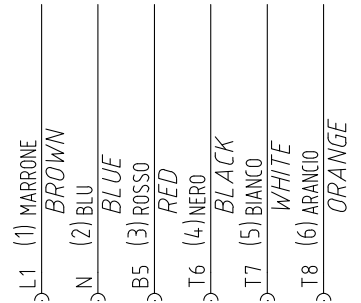

CAVO 7x0,75mmq
7x0,75mmq CABLE

(xx)
ATTENZIONE COLLEGAMENTO SONDE CON CONNETTORE 7 POLI
WARNING PROBE CONNECTION WITH 7 PINS CONNECTOR

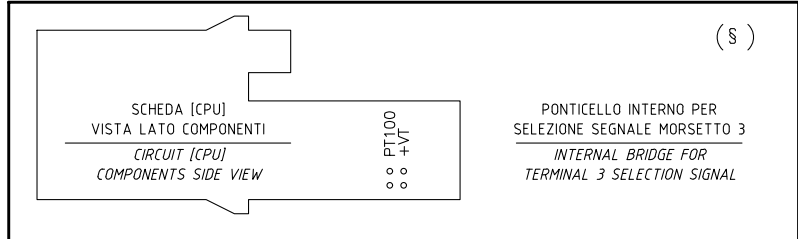

§
VERSIONE (PR) / VERSIONE (MD) CON RWF.. / 600V / KM3
(PR) VERSION / (MD) VERSION WITH RWF.. / 600V / KM3

Data	22/07/2013	PREC.	FOGLIO
Revisione	02	5	6
Dis. N.	05-1004 - A	SEGUE	TOTALE
		7	11

(xx)

ATTENZIONE COLLEGAMENTO SONDE CON CONNETTORE 7 POLI
 WARNING PROBE CONNECTION WITH 7 PINS CONNECTOR

KM3 HCRMMD

600V RRR0-1-T73

RWF55.5x

RWF50.2x

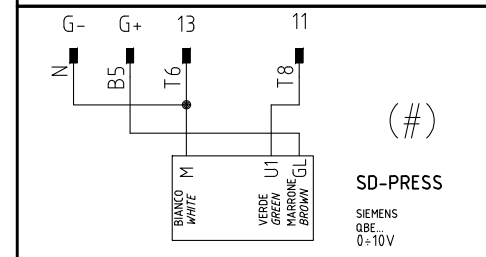
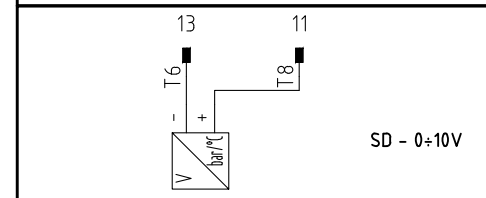
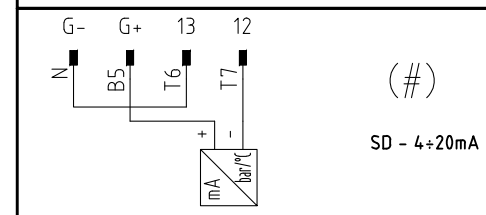
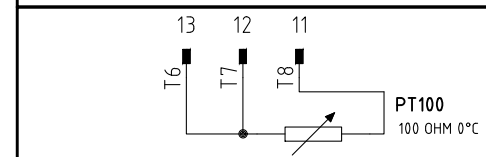
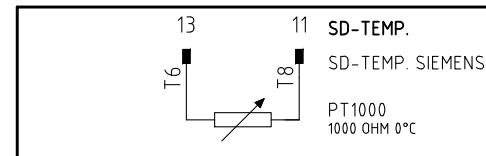
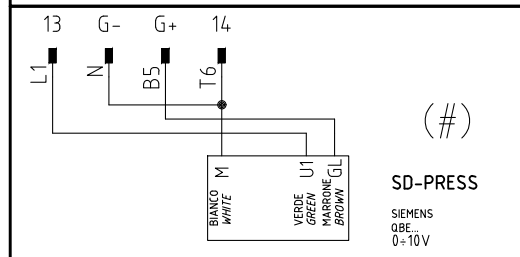
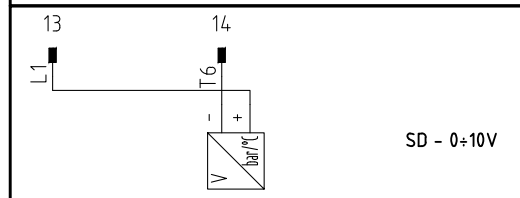
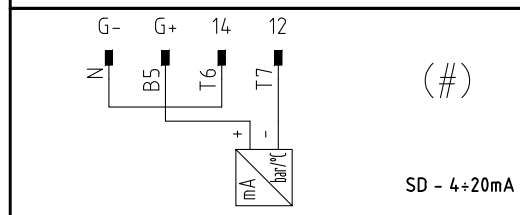
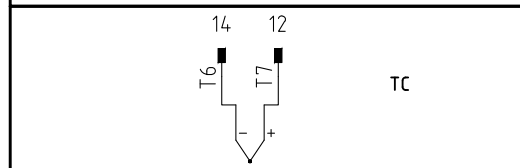
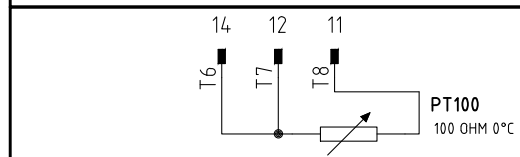
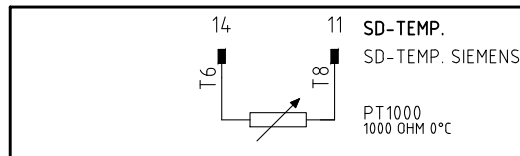
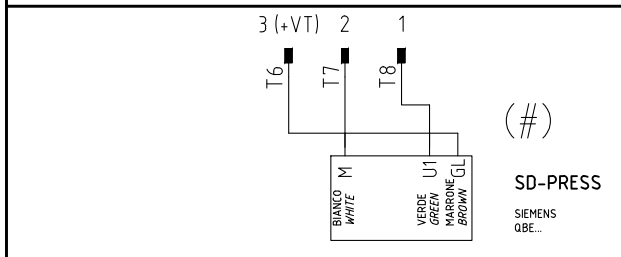
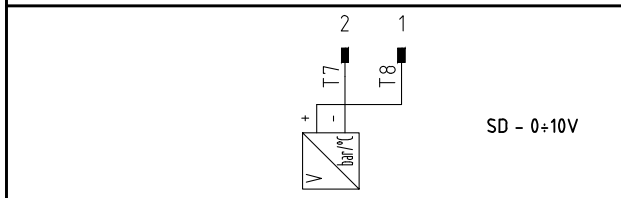
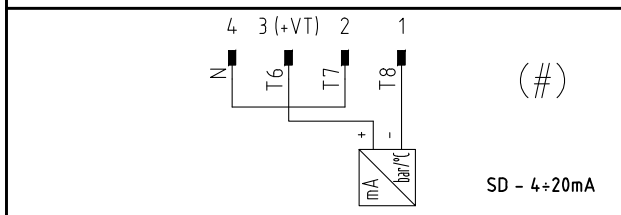
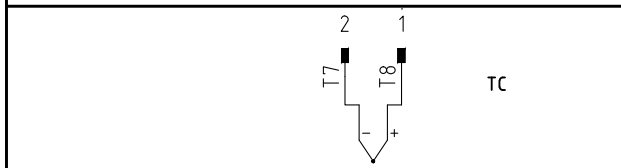
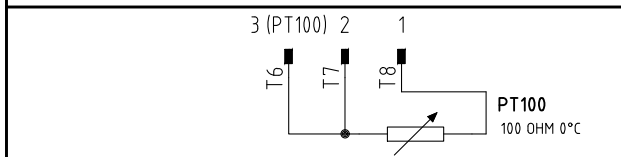
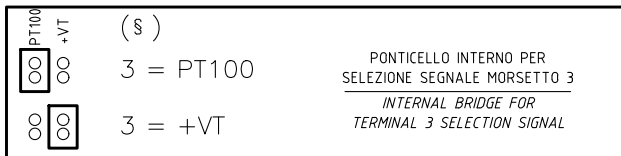
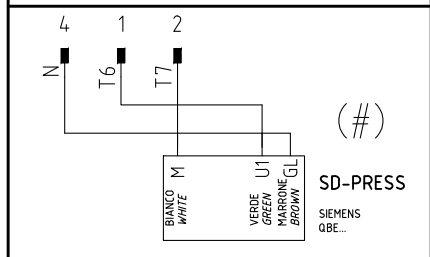
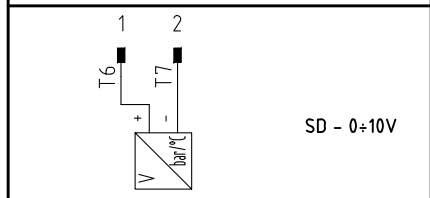
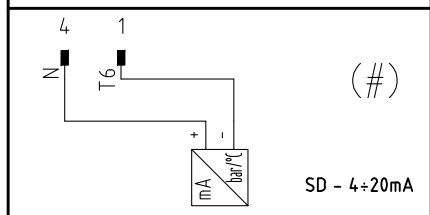
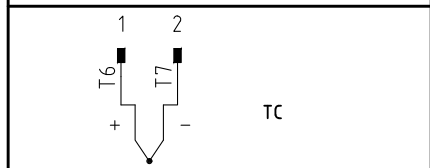
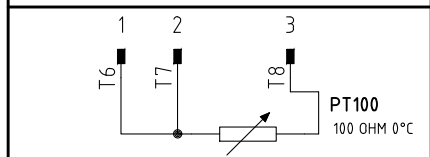
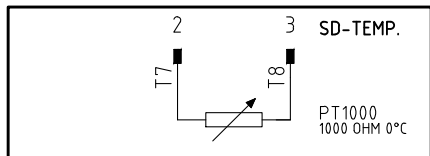

(#)

COLLEGAMENTO SOLO PER
 TRASDUTTORI PASSIVI
 TRANSDUCER PASSIVE
 CONNECTION ONLY

Data	22/07/2013	PREC.	FOGLIO
Revisione	02	6	7
Dis. N.	05-1004 - A	SEGUE	TOTALE
		8	11

QG - MA
 MORSETTIERA ALIMENTAZIONE BRUCIATORE
 BURNER SUPPLY TERMINAL BOARD

220V / 230V / 240V 3 a.c.

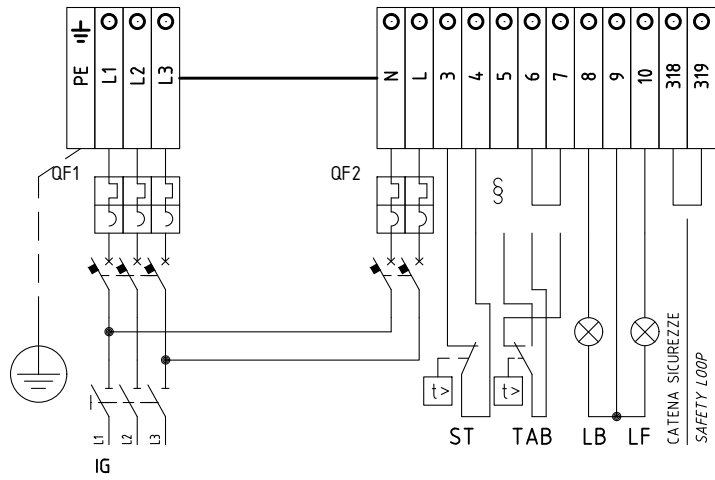

LIMITE DI FORNITURA
 SCOPE OF SUPPLY

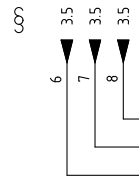

VERSIONE (PR) / VERSIONE (MD) CON RWF.. / 600V / KM3
 (PR) VERSION / (MD) VERSION WITH RWF.. / 600V / KM3

SE USATO "TAB" O "MD", TOGLIERE IL PONTE TRA I MORSETTI 6 - 7
 IF USED "TAB" OR "MD", REMOVE THE BRIDGE BETWEEN TERMINALS 6 - 7

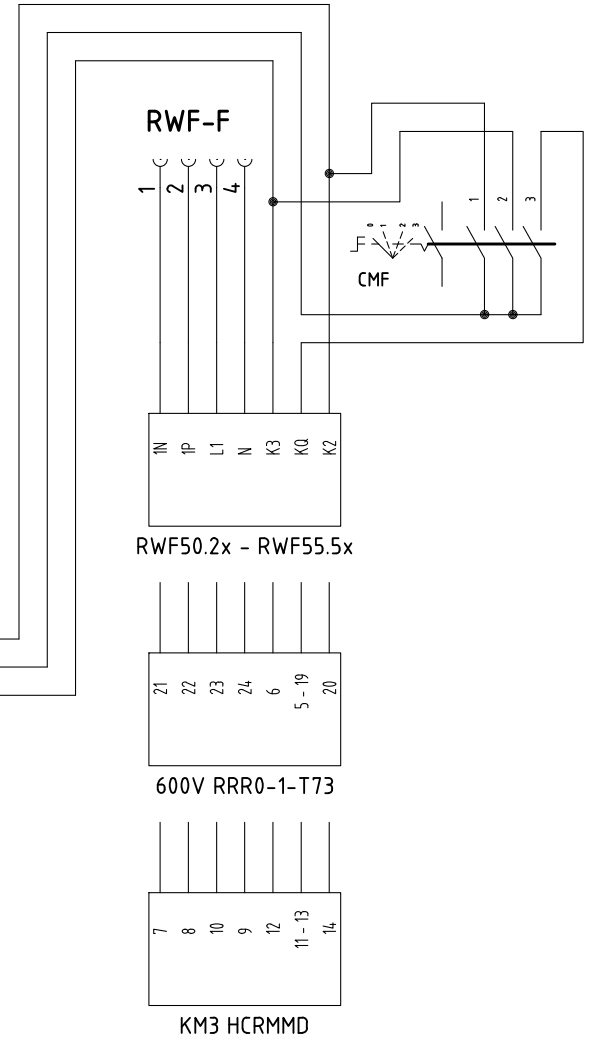

FQA-M

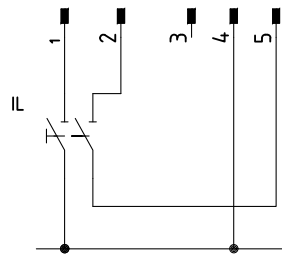

FQC-F

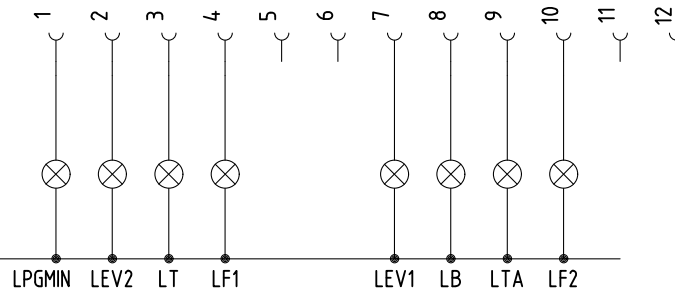

Data	22/07/2013	PREC.	FOGLIO
Revisione	02	7	8
Dis. N.	05-1004 - A	SEGUE	TOTALE
		9	11

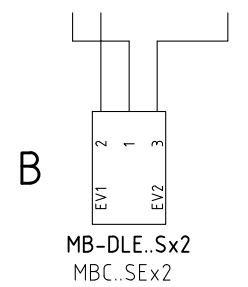
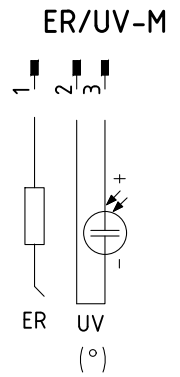
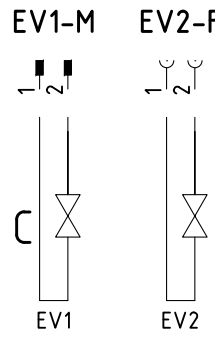
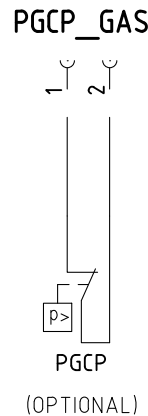
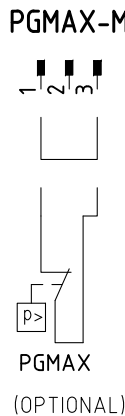
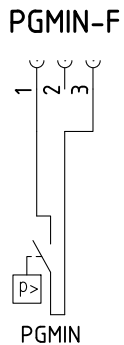
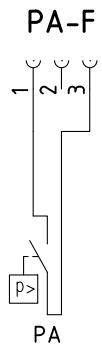
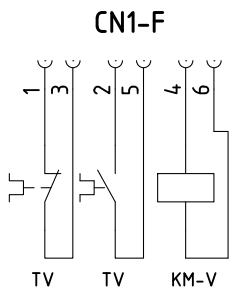

(°)
SONDA "UV" IN ALTERNATIVA A ELETTRODO "ER"
"UV" PROBE ALTERNATIVE TO "ER"

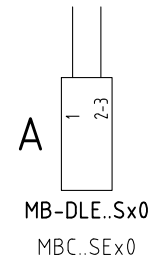

ESECUZIONE [A] = SOLO SENZA CONTROLLO TENUTA
[A] PERFORMANCE = WITHOUT GAS LEAKAGE ONLY

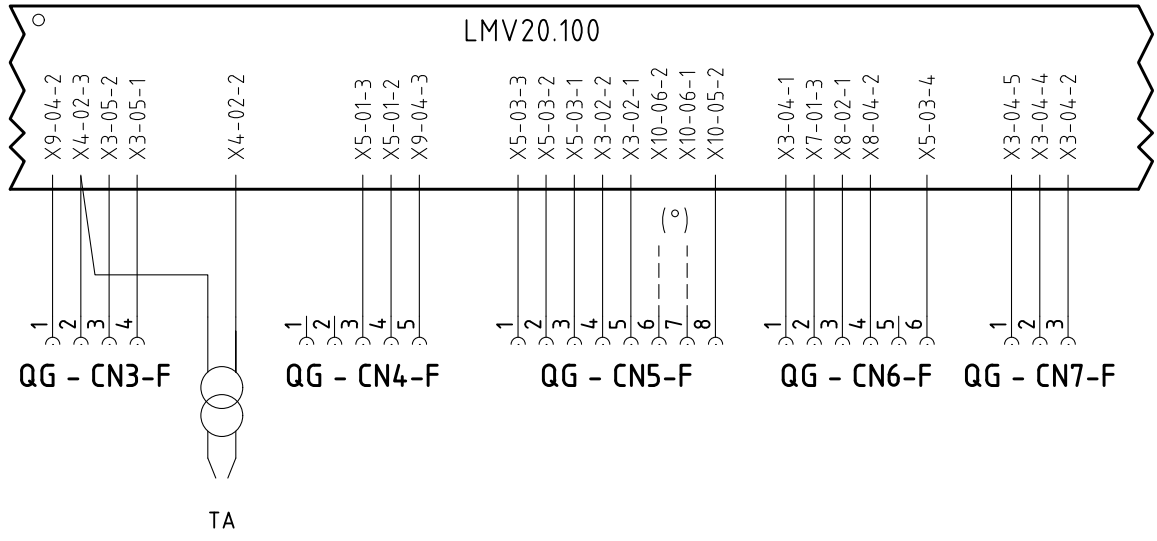
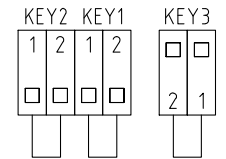

Data	22/07/2013	PREC.	FOGLIO
Revisione	02	8	9
Dis. N.	05-1004 - A	SEGUE	TOTALE
		10	11

Sigla/Item	Foglio/Sheet	Funzione	Function
600V RRR0-1-T73	6	REGOLATORE MODULANTE (ALTERNATIVO)	BURNER MODULATOR (ALTERNATIVE)
AZL2x..	5	INTERFACCIA UTENTE	USER INTERFACE
C	2	CONDENSATORE	CAPACITOR
CMF	6	COMMUT. MANUALE FUNZ. 0)FERMO 1)ALTA FIAMMA 2)BASSA FIAMMA 3)AUTOMATICO	MANUAL SWITCH 0)OFF 1)HIGH FLAME 2)LOW FLAME 3)AUTOMATIC
ER	5	ELETTRODO RILEVAZIONE FIAMMA	FLAME DETECTION ELECTRODE
EV1	4	ELETTROVALVOLA GAS LATO RETE	UPSTREAM GAS SOLENOID VALVE
EV2	4	ELETTROVALVOLA GAS LATO BRUCIATORE	DOWNSTREAM GAS SOLENOID VALVE
EVS	3	ELETTROVALVOLA GAS DI SICUREZZA (OPTIONAL)	SAFETY GAS SOLENOID VALVE (OPTIONAL)
FU1	1	FUSIBILE AUSILIARIO	AUXILIARY FUSE
FU2	6	FUSIBILE	FUSE
IG	1	INTERRUTTORE GENERALE	MAINS SWITCH
IL	1	INTERRUTTORE LINEA AUSILIARI	AUXILIARY LINE SWITCH
KM3 HCRMMD	6	REGOLATORE MODULANTE (ALTERNATIVO)	BURNER MODULATOR (ALTERNATIVE)
KM-V	2	CONTATTORE MOTORE VENTILATORE	FAN MOTOR CONTACTOR
LB	2	LAMPADA SEGNALAZIONE BLOCCO BRUCIATORE	INDICATOR LIGHT FOR BURNER LOCK-OUT
LEV1	4	LAMPADA SEGNALAZIONE APERTURA [EV1]	INDICATOR LIGHT FOR OPENING OF ELECTRO-VALVE [EV1]
LEV2	4	LAMPADA SEGNALAZIONE APERTURA [EV2]	INDICATOR LIGHT FOR OPENING OF ELECTRO-VALVE [EV2]
LF1	4	LAMPADA SEGNALAZIONE FUNZIONAMENTO BRUCIATORE	INDICATOR LIGHT BURNER OPERATION
LF2	4	LAMPADA SEGNALAZIONE FUNZIONAMENTO BRUCIATORE	INDICATOR LIGHT BURNER OPERATION
LMV20.100	1	APPARECCHIATURA DI COMANDO	CONTROL SCHEME
LPGMIN	3	LAMPADA SEGNALAZIONE PRESENZA GAS IN RETE	INDICATOR LIGHT FOR PRESENCE OF GAS IN THE NETWORK
LT	2	LAMPADA SEGNALAZIONE BLOCCO TERMICO MOTORE VENTILATORE	INDICATOR LIGHT FOR FAN MOTOR OVERLOAD THERMAL CUTOUT
LT	1	LAMPADA SEGNALAZIONE BLOCCO TERMICO MOTORE VENTILATORE	INDICATOR LIGHT FOR FAN MOTOR OVERLOAD THERMAL CUTOUT
LTA	2	LAMPADA SEGNALAZIONE TRASFORMATORE DI ACCENSIONE	IGNITION TRANSFORMER INDICATOR LIGHT
MB-DLE..Sx0	4	GRUPPO VALVOLE GAS	GAS VALVES GROUP
MB-DLE..Sx2	4	GRUPPO VALVOLE GAS	GAS VALVES GROUP
MBC..SEx0	4	GRUPPO VALVOLE GAS (ALTERNATIVO)	GAS VALVES GROUP (ALTERNATIVE)
MBC..SEx2	4	GRUPPO VALVOLE GAS (ALTERNATIVO)	GAS VALVES GROUP (ALTERNATIVE)
MV	1	MOTORE VENTILATORE	FAN MOTOR
PA	1	PRESSOSTATO ARIA	AIR PRESSURE SWITCH
PGCP_GAS	4	PRESSOSTATO GAS CONTROLLO PERDITE (OPTIONAL)	GAS LEAKAGE PRESSURE SWITCH (OPTIONAL)
PGMAX	5	PRESSOSTATO GAS DI MASSIMA PRESSIONE (OPTIONAL)	MAXIMUM PRESSURE GAS SWITCH (OPTIONAL)

Data	22/07/2013	PREC.	FOGLIO
Revisione	02	9	10
Dis. N.	05-1004 - A	SEGUE	TOTALE
		11	11

Sigla/Item	Foglio/Sheet	Funzione	Function
PGMIN	3	PRESSOSTATO GAS DI MINIMA PRESSIONE	MINIMUM GAS PRESSURE SWITCH
PT100	7	SONDA DI TEMPERATURA	TEMPERATURE PROBE
QF1	1	MAGNETOTERMICO PROTEZIONE ALIMENTAZIONE TRIFASE	THREE-PHASE POWER CIRCUIT BREAKER PROTECTION
QF2	1	MAGNETOTERMICO PROTEZIONE LINEA AUSILIARI	AUXILIARY SUPPLY CIRCUIT BREAKER PROTECTION
R	2	RESISTENZA	RESISTOR
RC	2	CIRCUITO RC SIEMENS	SIEMENS RC CIRCUIT
RWF50.2x	6	REGOLATORE MODULANTE	BURNER MODULATOR
RWF55.5x	6	REGOLATORE MODULANTE (ALTERNATIVO)	BURNER MODULATOR (ALTERNATIVE)
SD-PRESS	7	SONDA DI PRESSIONE	PRESSURE PROBE
SD-TEMP.	7	SONDA DI TEMPERATURA	TEMPERATURE PROBE
SD - 0÷10V	7	TRASDUTTORE USCITA IN TENSIONE	TRANSDUCER VOLTAGE OUTPUT
SD - 4÷20mA	7	TRASDUTTORE USCITA IN CORRENTE	TRANSDUCER CURRENT OUTPUT
SQN1../SQM3.. AIR	5	SERVOCOMANDO SERRANDA ARIA	AIR DAMPER ACTUATOR
SQN1../SQM3.. FUEL	5	SERVOCOMANDO COMBUSTIBILE	FUEL ACTUATOR
ST	3	SERIE TERMOSTATI/PRESSOSTATI	SERIES OF THERMOSTATS OR PRESSURE SWITCHES
TA	2	TRASFORMATORE DI ACCENSIONE	IGNITION TRANSFORMER
TAB	3	TERMOSTATO/PRESSOSTATO ALTA-BASSA FIAMMA	HIGH-LOW THERMOSTAT/PRESSURE SWITCHES
TC	7	TERMOCOPPIA	THERMOCOUPLE
TV	1	TERMICO MOTORE VENTILATORE	FAN MOTOR THERMAL
UV	5	SONDA UV RILEVAZIONE FIAMMA	UV FLAME DETECTOR

Data	22/07/2013	PREC.	FOGLIO
Revisione	02	10	11
Dis. N.	05-1004 - A	SEGUE	TOTALE
		12	11

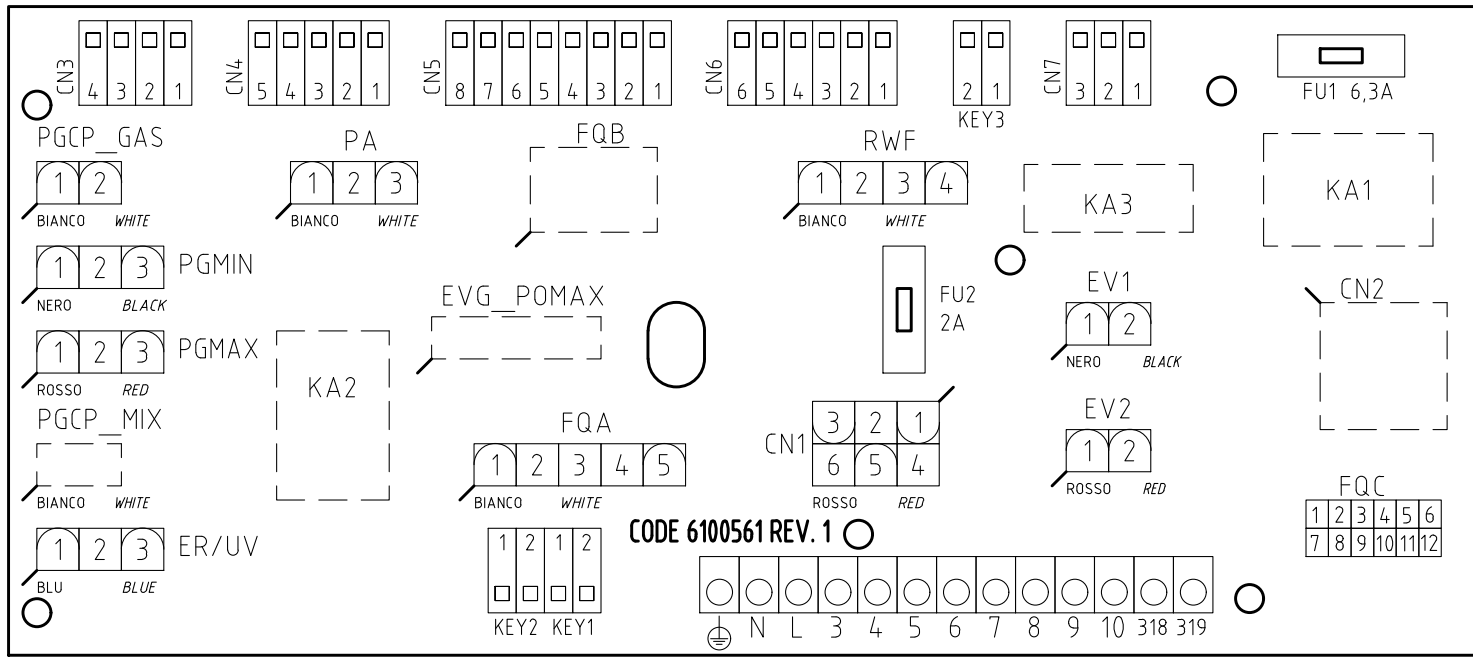
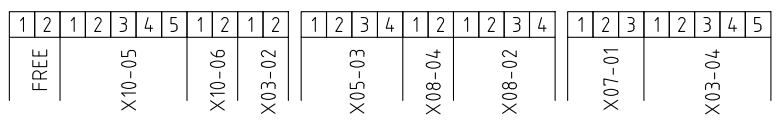
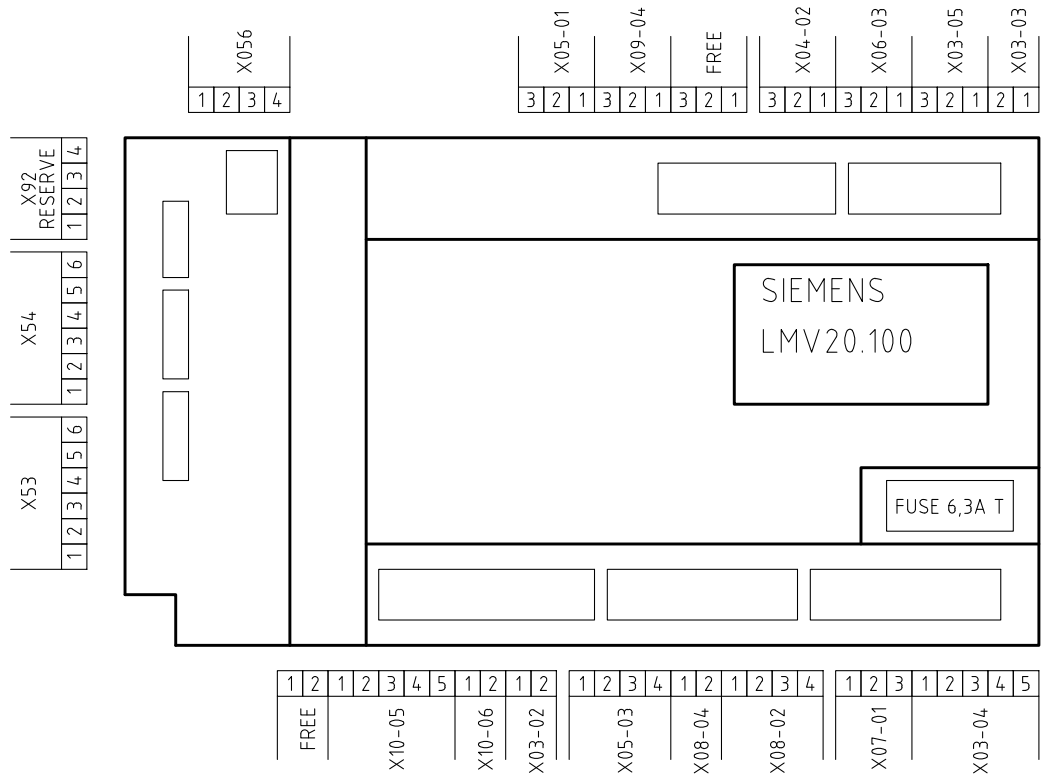

CODE 6100561 REV. 1

VISTA LATO COMPONENTI
COMPONENTS SIDE VIEW

Data	22/07/2013	PREC.	FOGLIO
Revisione	02	11	12
Dis. N.	05-1004 - A	SEGUE	TOTALE
	/		11