

RG91 - RG92 - RG93
RG510 - RG515
RG520 - RG525

Light oil burners

Progressive, Fully-modulating

MANUAL OF INSTALLATION - USE - MAINTENANCE



BURNERS - BRUCIATORI - BRULERS - BRENNER - QUEMADORES - ГОРЕЛКИ

DANGERS, WARNINGS AND NOTES OF CAUTION

THIS MANUAL IS SUPPLIED AS AN INTEGRAL AND ESSENTIAL PART OF THE PRODUCT AND MUST BE DELIVERED TO THE USER.

INFORMATION INCLUDED IN THIS SECTION ARE DEDICATED BOTH TO THE USER AND TO PERSONNEL FOLLOWING PRODUCT INSTALLATION AND MAINTENANCE.

THE USER WILL FIND FURTHER INFORMATION ABOUT OPERATING AND USE RESTRICTIONS, IN THE SECOND SECTION OF THIS MANUAL. WE HIGHLY RECOMMEND TO READ IT.

CAREFULLY KEEP THIS MANUAL FOR FUTURE REFERENCE.

1) GENERAL INTRODUCTION

- The equipment must be installed in compliance with the regulations in force, following the manufacturer's instructions, by qualified personnel.
- Qualified personnel means those having technical knowledge in the field of components for civil or industrial heating systems, sanitary hot water generation and particularly service centres authorised by the manufacturer.
- Improper installation may cause injury to people and animals, or damage to property, for which the manufacturer cannot be held liable.
- Remove all packaging material and inspect the equipment for integrity. In case of any doubt, do not use the unit - contact the supplier.

The packaging materials (wooden crate, nails, fastening devices, plastic bags, foamed polystyrene, etc), should not be left within the reach of children, as they may prove harmful.

- Before any cleaning or servicing operation, disconnect the unit from the mains by turning the master switch OFF, and/or through the cut-out devices that are provided.
- Make sure that inlet or exhaust grilles are unobstructed.
- In case of breakdown and/or defective unit operation, disconnect the unit. Make no attempt to repair the unit or take any direct action.

Contact qualified personnel only.

Units shall be repaired exclusively by a servicing centre, duly authorised by the manufacturer, with original spare parts and accessories.

Failure to comply with the above instructions is likely to impair the unit's safety.

To ensure equipment efficiency and proper operation, it is essential that maintenance operations are performed by qualified personnel at regular intervals, following the manufacturer's instructions.

- When a decision is made to discontinue the use of the equipment, those parts likely to constitute sources of danger shall be made harmless.
- In case the equipment is to be sold or transferred to another user, or in case the original user should move and leave the unit behind, make sure that these instructions accompany the equipment at all times so that they can be consulted by the new owner and/or the installer.
- This unit shall be employed exclusively for the use for which it is meant. Any other use shall be considered as improper and, therefore, dangerous.

The manufacturer shall not be held liable, by agreement or otherwise, for damages resulting from improper installation, use and failure to comply with the instructions supplied by the manufacturer. The occurrence of any of the following circumstances may cause explosions, polluting unburnt gases (example: carbon monoxide CO), burns, serious harm to people, animals and things:

- Failure to comply with one of the WARNINGS in this chapter
- Incorrect handling, installation, adjustment or maintenance of the burner
- Incorrect use of the burner or incorrect use of its parts or optional supply

2) SPECIAL INSTRUCTIONS FOR BURNERS

- The burner should be installed in a suitable room, with ventilation openings complying with the requirements of the regulations in force, and sufficient for good combustion.
- Only burners designed according to the regulations in force should be used.
- This burner should be employed exclusively for the use for which it was designed.
- Before connecting the burner, make sure that the unit rating is the same as delivery mains (electricity, gas oil, or other fuel).
- Observe caution with hot burner components. These are, usually, near to the flame and the fuel pre-heating system, they become hot during the unit operation and will remain hot for some time after the burner has stopped.

When the decision is made to discontinue the use of the burner, the user shall have qualified personnel carry out the following operations:

- a Remove the power supply by disconnecting the power cord from the mains.
- b Disconnect the fuel supply by means of the hand-operated shut-off valve and remove the control handwheels from their spindles.

Special warnings

- Make sure that the burner has, on installation, been firmly secured to the appliance, so that the flame is generated inside the appliance fire-box.
- Before the burner is started and, thereafter, at least once a year, have qualified personnel perform the following operations:
 - a set the burner fuel flow rate depending on the heat input of the appliance;
 - b set the flow rate of the combustion-supporting air to obtain a combustion efficiency level at least equal to the lower level required by the regulations in force;
 - c check the unit operation for proper combustion, to avoid any harmful or polluting unburnt gases in excess of the limits permitted by the regulations in force;
 - d make sure that control and safety devices are operating properly;
 - e make sure that exhaust ducts intended to discharge the products of combustion are operating properly;
 - f on completion of setting and adjustment operations, make sure that all mechanical locking devices of controls have been duly tightened;
 - g make sure that a copy of the burner use and maintenance instructions is available in the boiler room.
- In case of a burner shut-down, reset the control box by means of the RESET pushbutton. If a second shut-down takes place, call the Technical Service, **without trying to RESET further**.
- The unit shall be operated and serviced by qualified personnel only, in compliance with the regulations in force.

3) GENERAL INSTRUCTIONS DEPENDING ON FUEL USED

3a) ELECTRICAL CONNECTION

- For safety reasons the unit must be efficiently earthed and installed as required by current safety regulations.
- It is vital that all safety requirements are met. In case of any doubt, ask for an accurate inspection of electrics by qualified personnel, since the manufacturer cannot be held liable for damages that may be caused by failure to correctly earth the equipment.
- Qualified personnel must inspect the system to make sure that it is adequate to take the maximum power used by the equipment shown on the equipment rating plate. In particular, make sure that the system cable cross section is adequate for the power absorbed by the unit.
- No adaptors, multiple outlet sockets and/or extension cables are permitted to connect the unit to the electric mains.
- An omnipolar switch shall be provided for connection to mains, as required by the current safety regulations.
- The use of any power-operated component implies observance of a few basic rules, for example:
 - do not touch the unit with wet or damp parts of the body and/or with bare feet;
 - do not pull electric cables;
 - do not leave the equipment exposed to weather (rain, sun, etc.) unless expressly required to do so;
 - do not allow children or inexperienced persons to use equipment;
- The unit input cable shall not be replaced by the user. In case of damage to the cable, switch off the unit and contact qualified personnel to replace. When the unit is out of use for some time the electric switch supplying all the power-driven components in the system (i.e. pumps, burner, etc.) should be switched off.

3b) FIRING WITH GAS, LIGHT OIL OR OTHER FUELS

GENERAL

- The burner shall be installed by qualified personnel and in compliance with regulations and provisions in force; wrong installation can cause injuries to people and animals, or damage to property, for which the manufacturer cannot be held liable.
- Before installation, it is recommended that all the fuel supply system pipes be carefully cleaned inside, to remove foreign matter that might impair the burner operation.
- Before the burner is commissioned, qualified personnel should inspect the following:
 - a the fuel supply system, for proper sealing;
 - b the fuel flow rate, to make sure that it has been set based on the firing rate required of the burner;
 - c the burner firing system, to make sure that it is supplied for the designed fuel type;
 - d the fuel supply pressure, to make sure that it is included in the range shown on the rating plate;
 - e the fuel supply system, to make sure that the system dimensions are adequate to the burner firing rate, and that the system is equipped with all the safety and control devices required by the regulations in force.
- When the burner is to remain idle for some time, the fuel supply tap or taps should be closed.

SPECIAL INSTRUCTIONS FOR USING GAS

Have qualified personnel inspect the installation to ensure that:

- a the gas delivery line and train are in compliance with the regulations and provisions in force;
 - b all gas connections are tight;
 - c the boiler room ventilation openings are such that they ensure the air supply flow required by the current regulations, and in any case are sufficient for proper combustion.
- Do not use gas pipes to earth electrical equipment.
 - Never leave the burner connected when not in use. Always shut the gas valve off.
 - In case of prolonged absence of the user, the main gas delivery valve to the burner should be shut off.

Precautions if you can smell gas

- a do not operate electric switches, the telephone, or any other item likely to generate sparks;
 - b immediately open doors and windows to create an air flow to purge the room;
 - c close the gas valves;
 - d contact qualified personnel.
- Do not obstruct the ventilation openings of the room where gas appliances are installed, to avoid dangerous conditions such as the development of toxic or explosive mixtures.

DIRECTIVES AND STANDARDS

Gas burners

European directives

- Regulation 2016/426/UE (appliances burning gaseous fuels)
- 2014/35/UE (Low Tension Directive)
- 2014/30/UE (Electromagnetic compatibility Directive)
- 2006/42/EC (Machinery Directive)

Harmonized standards

- UNI EN 676 (Automatic forced draught burners for gaseous fuels)
- EN 55014-1 (Electromagnetic compatibility- Requirements for household appliances, electric tools and similar apparatus)
- EN 60204-1:2006 (Safety of machinery – Electrical equipment of machines.)
- CEI EN 60335-1 (Specification for safety of household and similar electrical appliances);
- CEI EN 60335-2-102 (Household and similar electrical appliances. Safety. Particular requirements for gas, oil and solid-fuel burning appliances having electrical connections).
- UNI EN ISO 12100:2010 (Safety of machinery - General principles for design - Risk assessment and risk reduction);

Light oil burners

European directives

- 2014/35/UE (Low Tension Directive)
- 2014/30/UE (Electromagnetic compatibility Directive)
- 2006/42/EC (Machinery Directive)

Harmonized standards

- UNI EN 267-2011(Automatic forced draught burners for liquid fuels)
- EN 55014-1 (Electromagnetic compatibility- Requirements for household appliances, electric tools and similar apparatus)
- EN 60204-1:2006 (Safety of machinery – Electrical equipment of machines.)
- CEI EN 60335-1 (Specification for safety of household and similar electrical appliances);
- CEI EN 60335-2-102 (Household and similar electrical appliances. Safety. Particular requirements for gas, oil and solid-fuel burning appliances having electrical connections).
- UNI EN ISO 12100:2010 (Safety of machinery - General principles for design - Risk assessment and risk reduction);

Heavy oil burners

European Directives

- 2014/35/UE (Low Tension Directive)
- 2014/30/UE (Electromagnetic compatibility Directive)
- 2006/42/EC (Machinery Directive)

Harmonized standards

- UNI EN 267(Automatic forced draught burners for liquid fuels)
- EN 55014-1 (Electromagnetic compatibility- Requirements for household appliances, electric tools and similar apparatus)
- EN 60204-1:2006 (Safety of machinery – Electrical equipment of machines.)
- CEI EN 60335-1 (Specification for safety of household and similar electrical appliances);
- CEI EN 60335-2-102 (Household and similar electrical appliances. Safety. Particular requirements for gas, oil and solid-fuel burning appliances having electrical connections).
- UNI EN ISO 12100:2010 (Safety of machinery - General principles for design - Risk assessment and risk reduction);

Gas - Light oil burners

European Directives

- Regulation 2016/426/UE (appliances burning gaseous fuels)
- 2014/35/UE (Low Tension Directive)
- 2014/30/UE (Electromagnetic compatibility Directive)
- 2006/42/EC (Machinery Directive)

Harmonized standards

- UNI EN 676 (Automatic forced draught burners for gaseous fuels)
- UNI EN 267 (Automatic forced draught burners for liquid fuels)
- EN 55014-1 (Electromagnetic compatibility- Requirements for household appliances, electric tools and similar apparatus)
- EN 60204-1:2006 (Safety of machinery – Electrical equipment of machines.)
- CEI EN 60335-1 (Specification for safety of household and similar electrical appliances);
- CEI EN 60335-2-102 (Household and similar electrical appliances. Safety. Particular requirements for gas, oil and solid-fuel burning appliances having electrical connections).
- UNI EN ISO 12100:2010 (Safety of machinery - General principles for design - Risk assessment and risk reduction);

Gas - Heavy oil burners

European directives:

- Regulation 2016/426/UE (appliances burning gaseous fuels)
- 2014/35/UE (Low Tension Directive)
- 2014/30/UE (Electromagnetic compatibility Directive)
- 2006/42/EC (Machinery Directive)

Harmonized standards

- UNI EN 676 (Automatic forced draught burners for gaseous fuels)
- EN 55014-1 (Electromagnetic compatibility- Requirements for household appliances, electric tools and similar apparatus)
- EN 60204-1:2006 (Safety of machinery – Electrical equipment of machines.)
- CEI EN 60335-1 (Specification for safety of household and similar electrical appliances);
- CEI EN 60335-2-102 (Household and similar electrical appliances. Safety. Particular requirements for gas, oil and solid-fuel burning appliances having electrical connections).
- UNI EN ISO 12100:2010 (Safety of machinery - General principles for design - Risk assessment and risk reduction);

Industrial burners

European directives

- Regulation 2016/426/UE (appliances burning gaseous fuels)
- 2014/35/UE (Low Tension Directive)
- 2014/30/UE (Electromagnetic compatibility Directive)
- 2006/42/EC (Machinery Directive)

Harmonized standards

- EN 55014-1 (Electromagnetic compatibility- Requirements for household appliances, electric tools and similar apparatus)
- EN 746-2 (Industrial thermoprocessing equipment - Part 2: Safety requirements for combustion and fuel handling systems)
- UNI EN ISO 12100:2010 (Safety of machinery - General principles for design - Risk assessment and risk reduction);
- EN 60204-1:2006 (Safety of machinery – Electrical equipment of machines.)
- EN 60335-2 (Electrical equipment of non-electric appliances for household and similar purposes. Safety requirements)

Burner data plate

For the following information, please refer to the data plate:

- burner type and burner model: must be reported in any communication with the supplier
- burner ID (serial number): must be reported in any communication with the supplier
- date of production (year and month)
- information about fuel type and network pressure

Type	--
Model	--
Year	--
S.Number	--
Output	--
Oil Flow	--
Fuel	--
Category	--
Gas Pressure	--
Viscosity	--
El.Supply	--
El.Consump.	--
Fan Motor	--
Protection	--
Drwaing n°	--
P.I.N.	--

SYMBOLS USED



WARNING!

Failure to observe the warning may result in irreparable damage to the unit or damage to the environment



DANGER!

Failure to observe the warning may result in serious injuries or death.



WARNING!

Failure to observe the warning may result in electric shock with lethal consequences

Figures, illustrations and images used in this manual may differ in appearance from the actual product.

BURNER SAFETY

The burners - and the configurations described below - comply with the regulations in force regarding health, safety and the environment. For more in-depth information, refer to the declarations of conformity that are an integral part of this Manual.



DANGER! Incorrect motor rotation can seriously damage property and injure people.

Residual risks deriving from misuse and prohibitions

The burner has been built in order to make its operation safe; there are, however, residual risks.



Do not touch any mechanical moving parts with your hands or any other part of your body. Injury hazard
Do not touch any parts containing fuel (i.e. tank and pipes). Scalding hazard
Do not use the burner in situations other than the ones provided for in the data plate.
Do not use fuels other than the ones stated.
Do not use the burner in potentially explosive environments.
Do not remove or by-pass any machine safety devices.
Do not remove any protection devices or open the burner or any other component while the burner is running.
Do not disconnect any part of the burner or its components while the burner is running.
Untrained staff must not modify any linkages.



After any maintenance, it is important to restore the protection devices before restarting the machine.
All safety devices must be kept in perfect working order.
Personnel authorized to maintain the machine must always be provided with suitable protections.



ATTENTION: while running, the parts of the burner near the generator (coupling flange) are subject to overheating. Where necessary, avoid any contact risks by wearing suitable PPE.

PART I: INSTALLATION

GENERAL FEATURES

The burners of this series represent monoblock burners made in die-cast aluminium housing with relative flange to work on heating generators. The maximum output range is from 2100kW to 8000kW (according to the model). They can be provided in progressive or fully-modulating version.

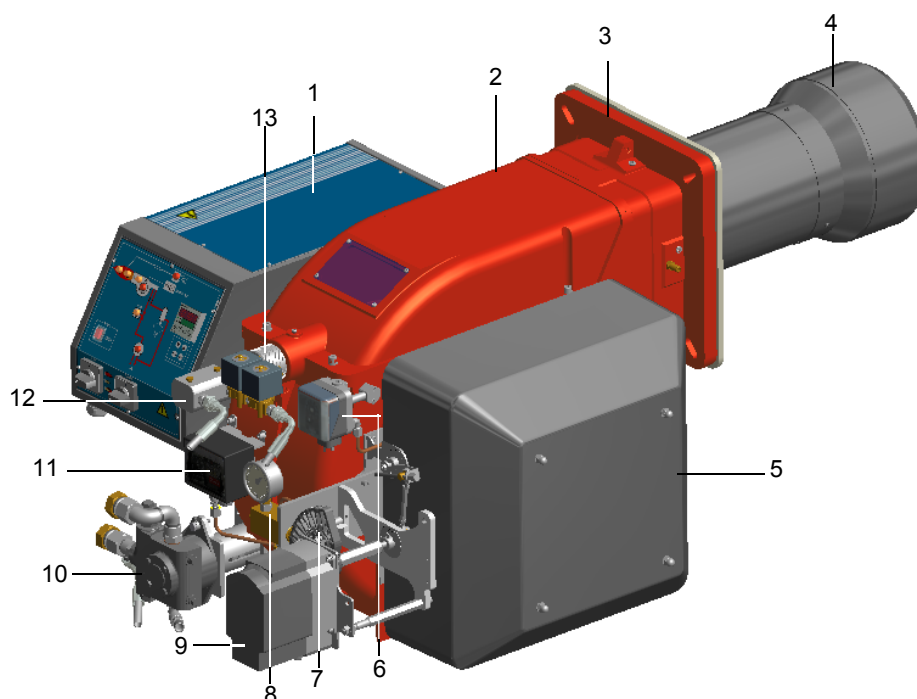

Note: the figure is indicative only

Keys

- 1 Mimic panel with startup switch
- 2 Cover
- 3 Flange
- 4 Blast tube-Combustion head group
- 5 Air intake
- 6 Air pressure switch
- 7 Adjusting cams
- 8 Oil pressure governor
- 9 Actuator
- 10 Pump
- 11 Oil pressure switch
- 12 Oil manifold
- 13 Head adjusting ring nut

The fuel coming from the supply line, is pushed by the pump to the nozzle and then into the combustion chamber, where the mixture between fuel and air takes place and consequently the flame. In the burners, the mixture between fuel and air, to perform clean and efficient combustion, is activated by atomisation of oil into very small particles. This process is achieved making pressurised oil passing through the nozzle.

The pump main function is to transfer oil from the tank to the nozzle in the desired quantity and pressure. To adjust this pressure, pumps are provided with a pressure regulator (except for some models for which a separate regulating valve is provided). Other pumps are provided with two pressure regulators: one for the high and one for low pressure (in double-stage systems with one nozzle).

In the double-stage burners, the electric actuator, that moves the air damper, allows the optimisation of the gas flue values, as to get an efficient combustion. The position of the combustion head determines the burner output. The air (comburent) and fuel (light oil) are forced into the combustion chamber, as to let the flame light up.

How to interpret the burner's "Performance curve"

To check if the burner is suitable for the boiler to which it must be installed, the following parameters are needed:

- furnace input, in kW or kcal/h ($\text{kW} = \text{kcal/h} / 860$);
- backpressure (data are available on the boiler's ID plate or in the user's manual).

Example:

Furnace input: 600kW

Backpressure: 4mbar

In the "Performance curve" diagram (Fig. 4), draw a vertical line matching the furnace input value and an horizontal line matching the backpressure value. The burner is suitable if the intersection point A is inside the performance curve.

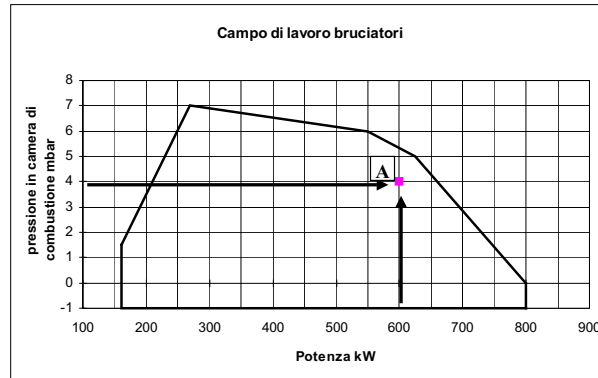

Fig. 4

Data are referred to standard conditions: atmospheric pressure at 1013mbar, ambient temperature at 15°C.

Burner model identification

Burners are identified by burner type and model. Burner model identification is described as follows.

Type	RG91	Model	G-. MD. S. *. A.
	(1)		(2) (3) (4) (5) (6)

1	BURNER TYPE	RG91, RG92, RG93, RG512, RG515, RG520, RG525
2	FUEL	G- Light oil, A- biodiesel
3	OPERATION (Available versions)	PR - Progressive , MD - Fully modulating
4	BLAST TUBE	S - Standard, L - Extended
5	DESTINATION COUNTRY	* - see data plate
6	BURNER VERSION	A - Standard, Y - Special

Burner performance

		RG91	RG92	RG93	RG510	RG515	RG520	RG525
Output	min. - max. kW	698 - 2093	849 - 2558	550 - 4100	1314 - 3953	1628 - 4884	2326 - 6977	2000 - 8000
Fuel		G - Light oil						
Protection		IP40						
Operation		Progressive - Fully modulating						
Operating temperature	°C	-10 ÷ +50						
Storage Temperature	°C	-20 ÷ +60						
Working service		(5)						

Electrical data 50 Hz

Possible voltages, check the actual three-phase and single-phase supply voltage on the burner nameplate.

Power supply triphase	V	380 400 415 +/-10% 50HZ 3 a.c.						
Auxiliary power supply Mono Phase	V	110 120 230V +/-10% 50HZ 2 a.c.						
	Hz	50						
Electric motor	kW	4,0	5,5	7,5	7,5	11,0	15,0	18,5
Pump motor	kW	1,1	1,1	1,1	1,1	1,5	1,5	3,0
Total power consumption	kW	5,6	7,1	9,1	9,1	13,0	17,0	22,0

Electrical data 60 Hz

Possible voltages, check the actual three-phase and single-phase supply voltage on the burner nameplate.

Power supply triphase	V	220 / 230 / 265 / 277 / 380 / 440 / 460 / 480 / 525 / 690 3 a.c.						
Auxiliary power supply Mono Phase	v	110 / 120 / 220 / 230 2 a.c.						
	Hz	60						
Electric motor	kW	4,8	6,6	9,0	9	13,2	18	22,2
Pump motor	kW	1,32	1,32	1,32	1,32	1,8	1,8	3,6
Total power consumption	kW	6,62	8,42	10,82	10,82	15,5	20,3	26,3

Fuel data

Light oil rate min.- max.	(Stm ³ /h)	59 - 176	72 - 215	46 - 345	111 - 333	137 - 411	196 - 588	169 - 674
Biodiesel rate min.- max.	(Stm ³ /h)	67 - 201	67 - 246	53 - 394	126 - 380	156 - 469	224 - 670	192 - 769
Gas pressure (2)	mbar	(see Note 2)						

Note 1:	All gas flow rates are referred to Stm ³ / h (1.013 mbar absolute pressure, 15 °C temperature) and are valid for G20 gas (net calorific value H _i = 34,02 MJ / Stm ³); for L.P.G. (net calorific value H _i = 93,5 MJ / Stm ³).							
Note 2:	Maximum gas pressure	360 mbar (with Dungs MBDLE).						
	Minimum gas pressure	500 mbar (with Siemens VGD or Dungs MultiBloc MBE).						
Note 3:	Burners are suitable only for indoor operation with a maximum relative humidity of 80 %.							
Note 4:	With electrode: for safety reasons the burner must stop automatically every 24 hours.							
Note 5:	The type of service can be continuous (flame signal presence for more than 24 h without any stop) or intermittent (at least once every 24 h there is a work stoppage and the flame is extinguished) depending on the configuration ordered. Operation can be continuous in the presence of flame detection via ION ionisation or Siemens QRI..., QRA5..., QRA7... or Lamtec FSS... with Siemens LMV37x or LMV5x flame control equipment (BMS) and Lamtec BT3...							

Performance curves

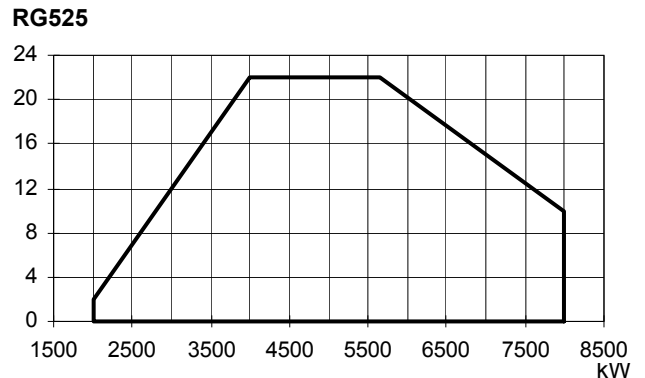
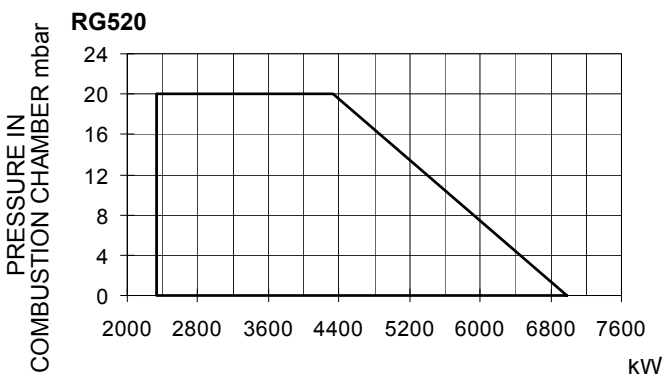
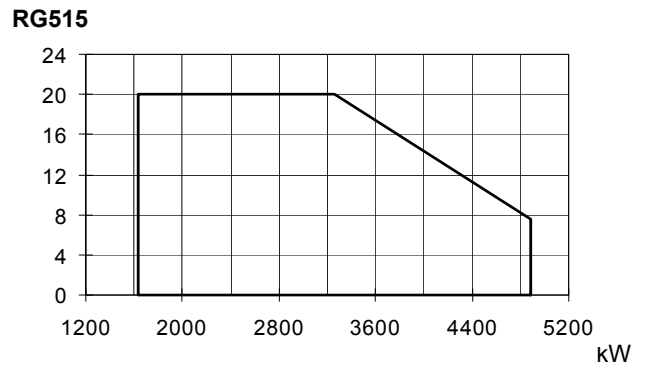
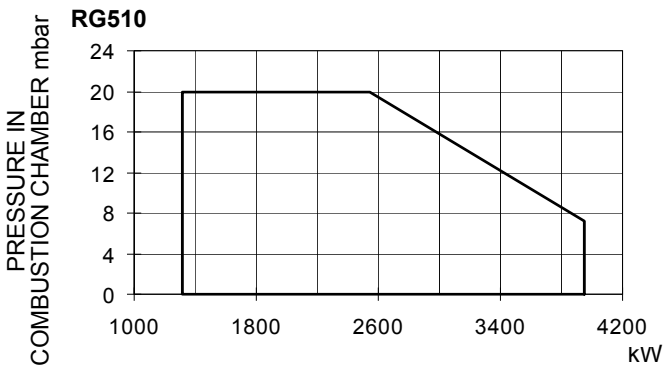
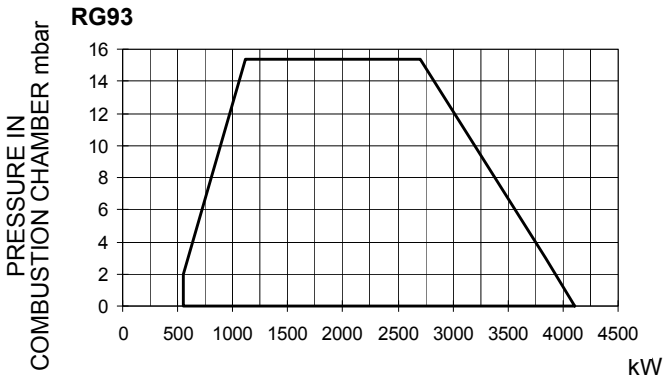
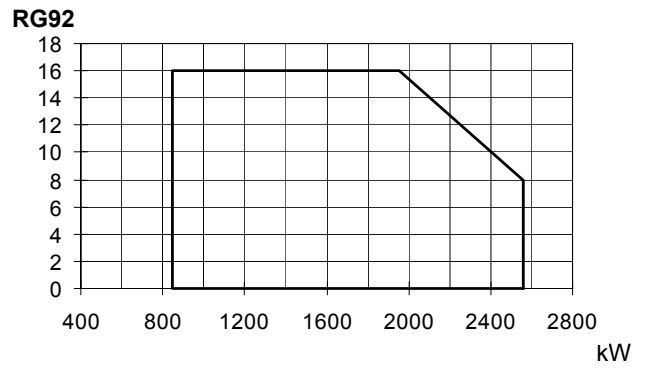
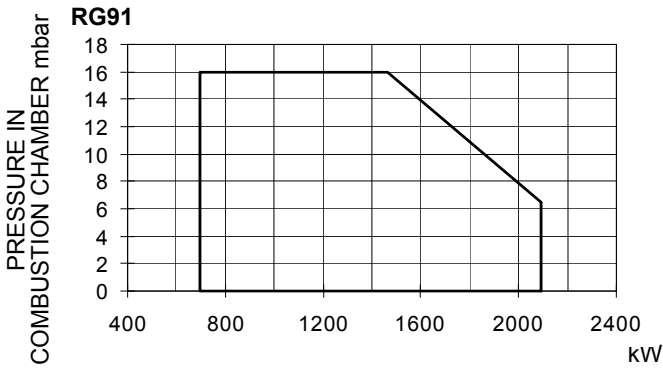

To get the input in kcal/h, multiply value in kW by 860.. Data are referred to standard conditions: atmospheric pressure at 1013mbar, ambient temperature at 15°C.

NOTE: The performance curve is a diagram that represents the burner performance in the type approval phase or in the laboratory tests, but does not represent the regulation range of the machine. On this diagram the maximum output point is usually reached by adjusting the combustion head to its "MAX" position (see paragraph "Adjusting the combustion head"); the minimum output point is reached setting the combustion head to its "MIN" position. During the first ignition, the combustion head is set in order to find a compromise between the burner output and the generator specifications, that is why the minimum output may be different from the Performance curve minimum.

Overall dimensions (mm)

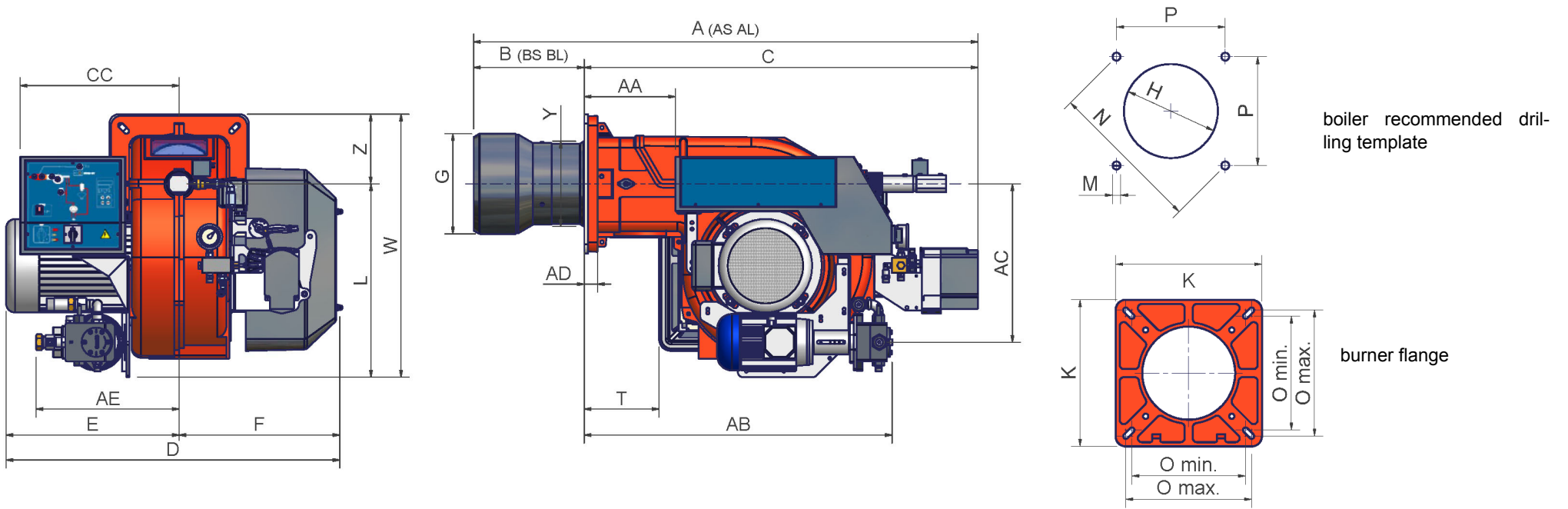

B*: SPECIAL blast tube lengths must be agreed with **Cib Unigas**

	A (AS)	A (AL)	AA	AB	AC	AD	AE	B*(BS)	B*(BL)	BB	C	CC	E	F	G	H	K	L	M	N	Omin	Omax	P	W	Y	Z
RG91	1345	1518	242	820	421	35	380	300	473	419	1045	422	419	434	238	268	360	513	M12	417	280	310	295	698	228	185
RG92	1339	1512	242	820	421	35	380	294	467	419	1045	422	419	434	266	296	360	513	M12	417	280	310	295	698	228	185
RG93	1339	1512	242	820	421	35	380	301	491	460	1045	422	460	434	292	322	360	513	M12	417	280	310	295	698	228	185

*AS/BS: measure referred to burner with standard blast tube provided

*AL/BL: measure referred to burner with extended blast tube provided

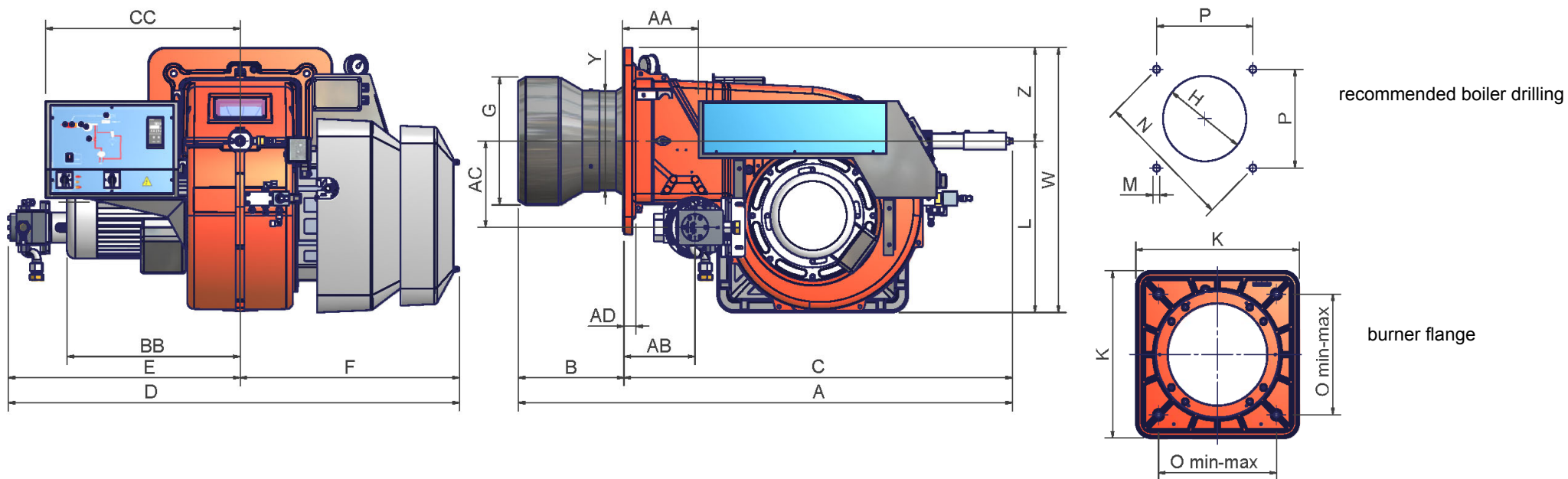

B*: SPECIAL blast tube lengths must be agreed with **Cib Unigas**

	A (AS)	A (AL)	AA	AB	AC	AD	B*(BS)	B*(BL)	BB	C	CC	D	E	F	G	H	K	L	M	N	O	P	UU	W	Y	Z
RG510	1451	1671	219	217	246	35	310	530	468	1141	571	1313	671	642	329	369	540	496	M14	552	390	390	x	766	328	270
RG515	1451	1671	219	217	246	35	310	530	508	1141	571	1323	681	642	350	390	540	496	M14	552	390	390	x	766	328	270
RG520	1451	1671	219	207	250	35	310	530	508	1141	571	1323	681	642	370	410	540	496	M14	552	390	390	114	880	328	270
RG525	1511	1691	219	197	275	35	350	530	650	1161	571	1341	698	642	434	484	540	496	M14	552	390	390	172	938	434	270

*AS/BS: measure referred to burner with standard blast tube provided measure referred to burner with standard blast tube provided

*AL/BL: measure referred to burner with extended blast tube provided measure referred to burner with extended blast tube provided

MOUNTINGS AND CONNECTIONS

Transport and storage



ATTENTION! The equipment must be installed in compliance with the regulations in force, following the manufacturer's instructions, by qualified personnel. All handling operations must be carried out with appropriate resources and qualified personnel



ATTENTION: Use intact and correctly dimensioned hoisting equipment, conforms to the local regulations and health and safety regulations. Do not stand under lifted loads.

If the product must be stored, avoid humid and corrosive places. Observe the temperatures stated in the burner data table at the beginning of this manual. The packages containing the burners must be locked inside the means of transport in such a way as to guarantee the absence of dangerous movements and avoid any possible damage.

In case of storage, the burners must be stored inside their packaging, in storerooms protected from the weather. Avoid humid or corrosive places and respect the temperatures indicated in the burner data table at the beginning of this manual.

Packing

The burners are dispatched in wooden packages whose dimensions are:

series 9x: 1720 mm x 1270 mm x 1020 mm (L x P x H)

series 5xx: 1800 mm x 1500 mm x 1300 mm (L x P x H)

Packing cases of this kind are affected by humidity and are not suitable for stacking. The following are placed in each packing case.

- burner;
- light oil flexible hoses;
- light oil filter;
- gasket to be inserted between the burner and the boiler;
- envelope containing this manual.

To get rid of the burner's packing, follow the procedures laid down by current laws on disposal of materials.

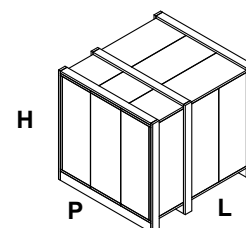

Fitting the burner to the boiler

To install the burner into the boiler, proceed as follows:

make a hole on the closing door of the combustion chamber as described on paragraph "Overall dimensions")

place the burner to the boiler: lift it up and handle it according to the procedure described on paragraph "Handling the burner";

place the 4 stud bolts (5), according to the burner's drilling plate described on paragraph "Overall dimensions";

fasten the 4 stud bolts;

place the ceramic fibre plait on the burner flange;

install the burner into the boiler;

fix the burner to the stud bolts, by means of the fixing nuts, according to the next picture.

After fitting the burner to the boiler, ensure that the gap between the blast tube and the refractory lining is sealed with appropriate insulating material (ceramic fibre cord or refractory cement).

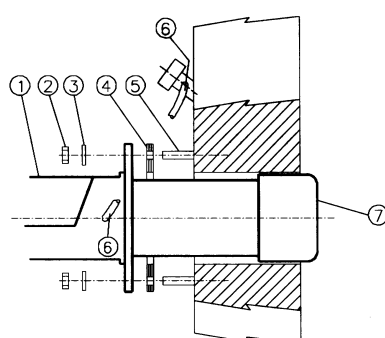

Keys

- 1 Burner
- 2 Fixing nut
- 3 Washer
- 4 Ceramic fibre plait
- 5 Stud bolt
- 7 Blast tube

Matching the burner to the boiler

The burners described in this manual have been tested with combustion chambers that comply with EN676 regulation and whose dimensions are described in the diagram. In case the burner must be coupled with boilers with a combustion chamber smaller in diameter or shorter than those described in the diagram, please contact the supplier, to verify that a correct matching is possible, with respect of the application involved. To correctly match the burner to the boiler verify the type of the blast tube. Verify the necessary input and the pressure in combustion chamber are included in the burner performance curve; otherwise the choice of the burner must be revised consulting the burner manufacturer. To choose the blast tube length follow the instructions of the boiler manufacturer. In absence of these consider the following:

- Cast-iron boilers, three pass flue boilers (with the first pass in the rear part): the blast tube must protrude no more than **Dist** = 100 mm into the combustion chamber. (please see the picture below)
- Pressurised boilers with flame reversal: in this case the blast tube must penetrate **Dm** 50 ÷ 100 mm into combustion chamber in respect to the tube bundle plate.(please see the picture below)

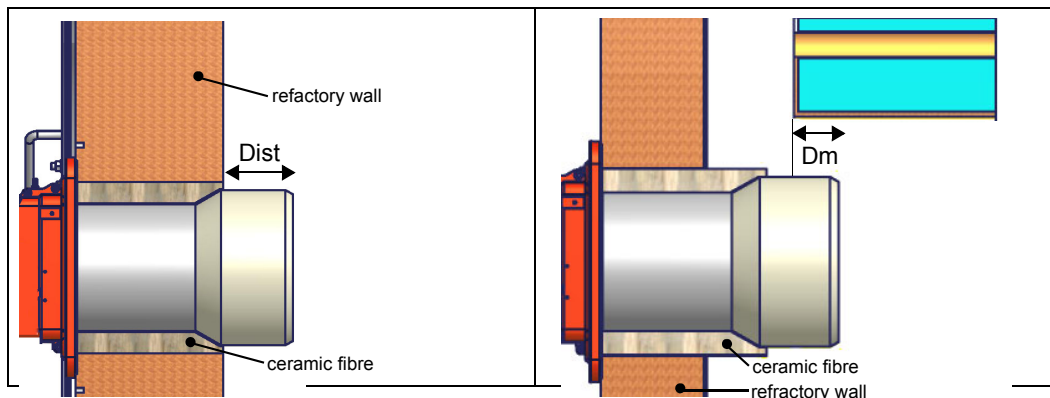

WARNING! Carefully seal the free space between blast tube and the refractory lining with ceramic fibre rope or other suitable means.

The length of the blast tubes does not always allow this requirement to be met, and thus it may be necessary to use a suitably-sized spacer to move the burner backwards or to design a blast tube that suits the utilisation (please, contact the manufacturer).

Handling the burner



ATTENTION! The handling operations must be carried out by specialised and trained personnel. If these operations are not carried out correctly, the residual risk for the burner to overturn and fall down still persists. To move the burner, use means suitable to support its weight (see paragraph "Technical specifications"). The unpacked burner must be lifted and moved only by means of a fork lift truck.

The burner is mounted on a stirrup provided for handling the burner by means of a fork lift truck: the forks must be inserted into the A and B ways. Remove the stirrup only once the burner is installed to the boiler.

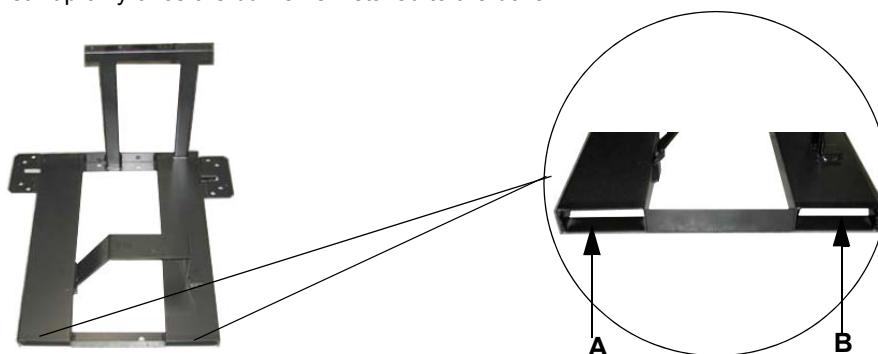

OIL TRAIN CONNECTIONS

Hydraulic diagrams for light oil supplying circuits

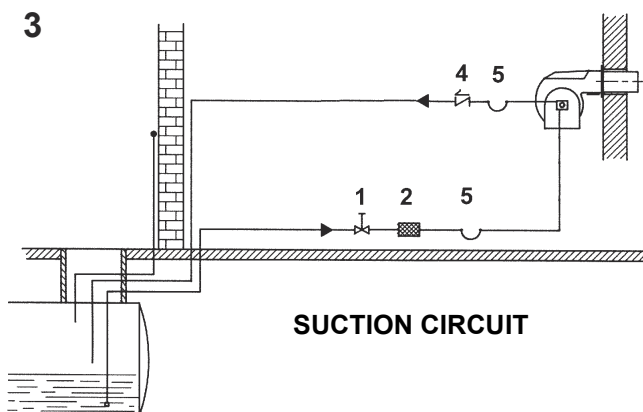
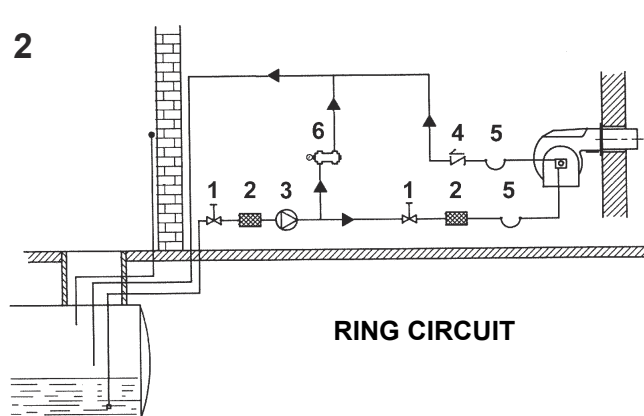
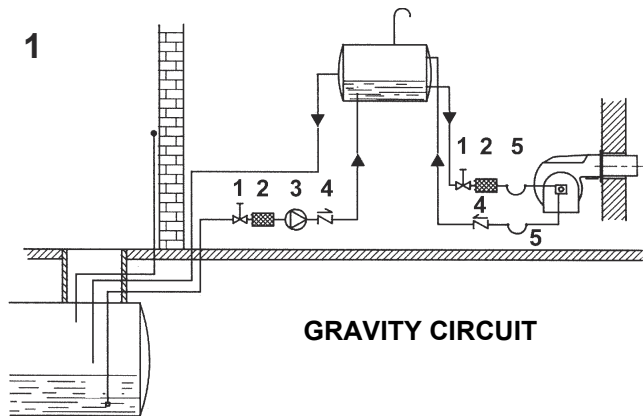

Key

- 1 Manual valve
- 2 Light oil filter
- 3 Light oil feeding pump
- 4 One way valve
- 5 Flexible hoses
- 6 Relief valve

NOTE: in plants where gravity or ring feed systems are provided, install an automatic interception device.

Installation diagram of light oil pipes

! PLEASE READ CAREFULLY THE “WARNINGS” CHAPTER AT THE BEGINNING OF THIS MANUAL.

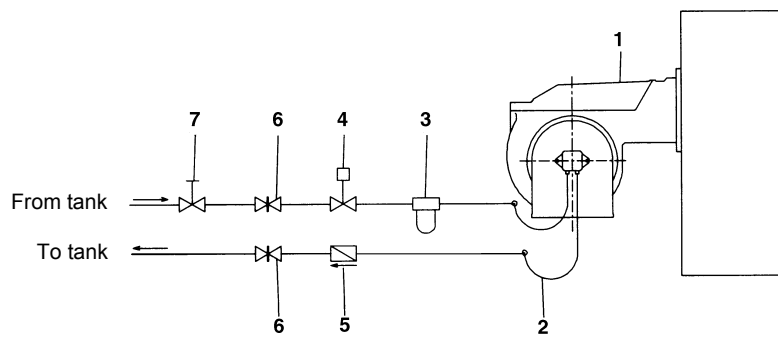

Double-pipe system

The burner is supplied with filter and flexible hoses, all the parts upstream the filter and downstream the return flexible hose, must be installed by the customer. As far as the hoses connection, see the related paragraph.

Key

- 1 Burner
- 2 Flexible hoses (fitted)
- 3 Light oil filter (fitted)
- 4 Automatic interceptor (*)
- 5 One-way valve (*)
- 6 Gate valve
- 7 Quick-closing gate-valve (outside the tank or boiler rooms)

(*) Only for installations with gravity, siphon or forced circulation feed systems. If the device installed is a solenoid valve, a timer must be installed to delay the valve closing.

The direct connection of the device without a timer may cause pump breaks.

The pumps that are used can be installed both into single-pipe and double-pipe systems.

Single-pipe system: a single pipe drives the oil from the tank to the pump's inlet. Then, from the pump, the pressurised oil is driven to the nozzle: a part comes out from the nozzle while the other part goes back to the pump. In this system, the by-pass plug, if provided, must be removed and the optional return port, on the pump's body, must be sealed by steel plug and washer.

Double-pipe system: as for the single pipe system, a pipe that connects the tank to the pump's inlet is used besides another pipe that connects the pump's return port to the tank, as well. The excess of oil goes back to the tank: this installation can be considered self-bleeding. If provided, the inside by-pass plug must be installed to avoid air and fuel passing through the pump.

Burners come out from the factory provided for double-stage systems. They can be suited for single-pipe system (recommended in the case of gravity feed) as described before.

● Suntec TA Pumps

To change from a 1-pipe system to a 2-pipe-system, insert the by-pass plug **G** (as for ccw-rotation- referring to the pump shaft).

Caution: Changing the direction of rotation, all connections on top and side are reversed.

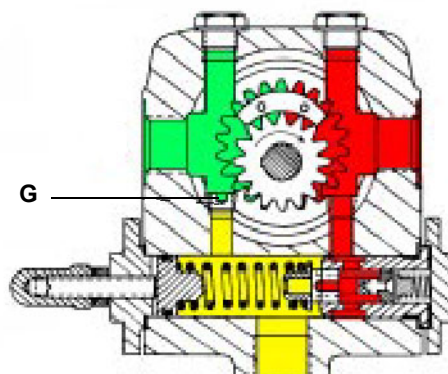

● Suntec T Pump

The bypass plug inserted between the pressure-side and shaft seal is only intended to change the pump rotation, check the presence of this plug by means of a 4 mm Allen key in the pressure outlet of the pump.

Caution: changing the direction of pump rotation involves changing of all pump connections.

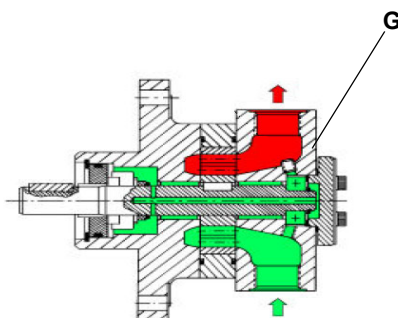

About the use of fuel pumps

- Do not use fuel with additives to avoid the possible formation over time of compounds which may deposit between the gear teeth, thus obstructing them.
- After filling the tank, wait before starting the burner. This will give any suspended impurities time to deposit on the bottom of the tank, thus avoiding the possibility that they might be sucked into the pump.
- On initial commissioning a "dry" operation is foreseen for a considerable length of time (for example, when there is a long suction line to bleed). To avoid damages inject some lubrication oil into the vacuum inlet.
- Care must be taken when installing the pump not to force the pump shaft along its axis or laterally to avoid excessive wear on the joint, noise and overloading the gears.
- Pipes should not contain air pockets. Rapid attachment joint should therefore be avoided and threaded or mechanical seal junctions preferred. Junction threads, elbow joints and couplings should be sealed with removable component. The number of junctions should be kept to a minimum as they are a possible source of leakage.
- Do not use PTFE tape on the suction and return line pipes to avoid the possibility that particles enter circulation. These could deposit on the pump filter or the nozzle, reducing efficiency. Always use O-Rings or mechanical seal (copper or aluminium gaskets) junctions if possible.
- An external filter should always be installed in the suction line upstream the fuel unit.



ATTENTION: before the burner first start, it is mandatory to fill the adduction pipes with diesel fuel and bleed out residual air bubbles. Prior to switching on the burner, check direction of rotation of the pump motor by briefly pressing the starter switch; ensure there are no anomalous sounds during equipment operation, and only then turn on the burner. Neglect to comply with this requirement will invalidate the burner warranty.

Light oil pumps

The pumps provided with these burners are Suntec TA (except mod. RG525).

RG525: Suntec T pump and Suntec TV pressure governor are provided.

Suntec TA..	
Oil viscosity	3 ÷ 75 cSt
Oil temperature	0 ÷ 150°C
Min. suction pressure	- 0.45 bar to avoid gasing
Max. suction pressure	5 bar
Max. return pressure	5 bar
Rotation speed	3600 rpm max.

- 1 Inlet G1/2
- 2 To the nozzle G1/2
- 3 Return G1/2
- 4 Pressure gauge port G1/4
- 5 Vacuum gauge port G1/4
- 6 Pressure governor

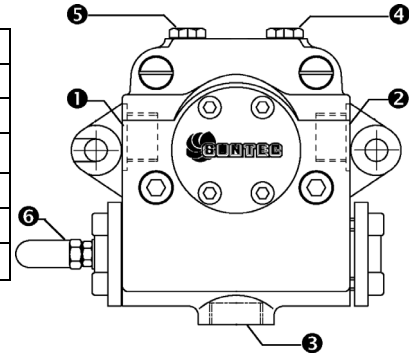

Suntec T..	
Viscosity	3 - 75 cSt
Oil temperature	0 - 150 °C
Minimum suction pressure	- 0.45 bar to prevent gasing
Maximum suction pressure	5 bar
Rated speed	3600 rpm max.

Key

- 1 Inlet G3/4
- 2 Pressure gauge port G1/4
- 3 Vacuum gauge port to measure the inlet vacuum G1/4
- 4 To pressure adjusting valve G3/4

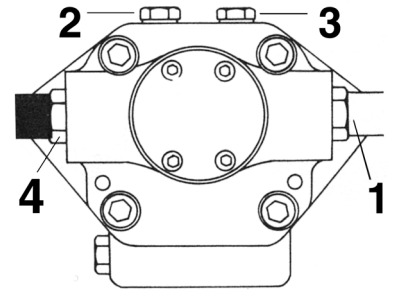

"Note: pump with "C" rotation.

Suntec TV Pressure governor

Pressure adjustment

Remove cap-nut 1 and the gasket 2, unscrew the lock nut 4. To increase pressure, twist adjusting screw 3 clockwise.

To decrease the pressure, twist screw counterclockwise. Tight the lock nut 4, refit the gasket 2 and the cap nut 1.

Key

- 1 Cap nut
- 2 Gasket
- 3 Adjusting screw
- 4 Lock nut
- 5 Gasket

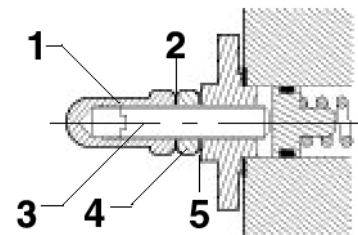

Assembling the light oil flexible hoses

To connect the flexible light oil hoses to the pump, proceed as follows, according to the pump provided:

- 1 remove the closing nuts **A** and **R** on the inlet and return connections of the pump;
- 2 screw the rotating nut of the two flexible hoses on the pump **being careful to avoid exchanging the inlet and return lines**: see the arrows marked on the pump that show the inlet and the return (see previous paragraph).

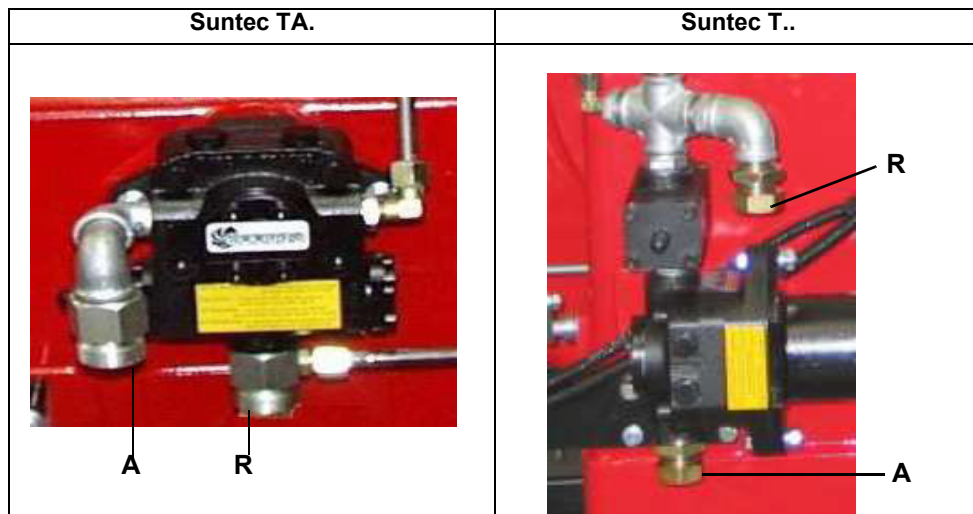

Diesel filters



	Item	Note	Connection	Max. operating pressure	Max. operating temperature	Filtering degree	Protection
5	20151PE (*)	-	3/8"	1 bar	-20, 60 °C	100 μ	-
6	20201PL (*)	-	3/8"	1 bar	-20, 60 °C	100 μ	-
7	GA70501	-	1"	4 bar	90 °C	100 μ	IP65

(*) Supplied per pilot diesel fuel if present

Oil circuit

The fuel is pushed into the pump 1 to the nozzle 3 at the delivery pressure set by the pressure governor. The solenoid valve 2 stops the fuel immission into the combustion chamber. The fuel flow rate that is not burnt goes back to the tank through the return circuit. The spill-back nozzle is feded at constant pressure, while the return line pressure is adjusted by means of the pressure governor controlled by an actuator coupled to an adjusting cam. The fuel amount to be burnt is adjusted by means of the burner actuator according to the adjustments set (see prevoius paragraph).

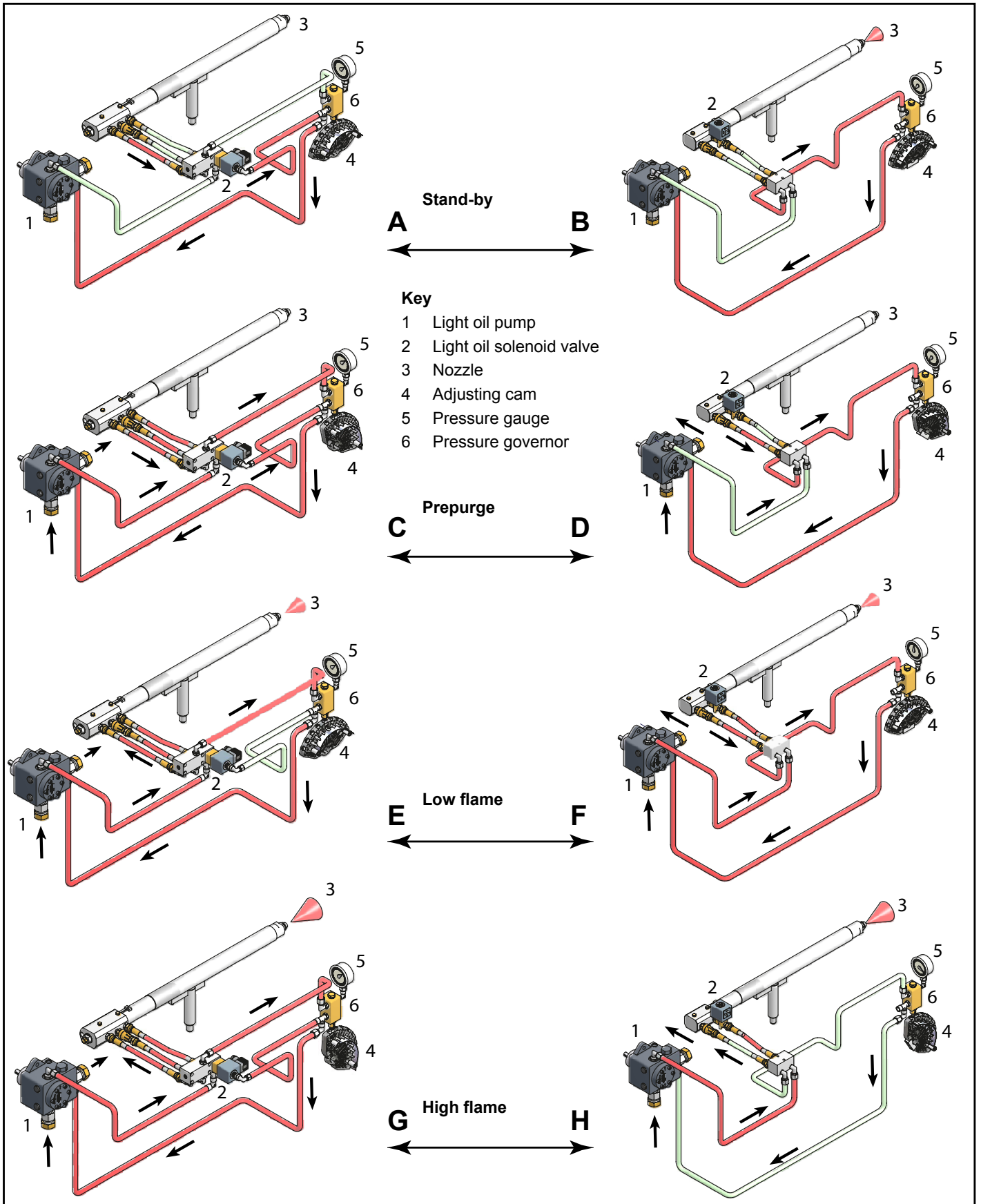

ELECTRICAL CONNECTIONS



WARNING! Respect the basic safety rules. make sure of the connection to the earthing system. do not reverse the phase and neutral connections. fit a differential thermal magnet switch adequate for connection to the mains. **WARNING!** before executing the electrical connections, pay attention to turn the plant's switch to OFF and be sure that the burner's main switch is in 0 position (OFF) too. Read carefully the chapter "WARNINGS", and the "Electrical connections" section.

ATTENTION: Connecting electrical supply wires to the burner terminal block MA, be sure that the ground wire is longer than phase and neutral ones.

- 7 To execute the electrical connections, proceed as follows:
- 1 remove the cover from the electrical board, unscrewing the fixing screws;
 - 2 execute the electrical connections to the supply terminal board as shown in the attached wiring diagrams;
 - 3 check the direction of the fan motor (see next paragraph);
 - 4 refit the panel cover.



WARNING: (only for double stage and progressive burners) The burner is provided with an electrical bridge between terminals 6 and 7; when connecting the high/low flame thermostat, remove this bridge before connecting the thermostat.

Rotation of electric motor

Once the electrical connection of the burner is executed, remember to check the rotation of the electric motor. The motor should rotate according to the "arrow" symbol on the body. In the event of wrong rotation, reverse the three-phase supply and check again the rotation of the motor.



CAUTION: check the motor thermal cut-out adjustment

NOTE: the burners are supplied for three-phase 380 V or 400 V supply, and in the case of three-phase 220 V or 230 V supply it is necessary to modify the electrical connections into the terminal box of the electric motor and replace the overload tripped relay.

ADJUSTING AIR AND LIGHT OIL FLOW RATE

Light oil nozzles

The oil flow rate can be adjusted choosing a nozzle that suits the boiler/utilisation output and setting the delivery and return pressure values according to the ones quoted on the following charts.

NOZZLE	NOZZLE SUPPLY PRESSURE (bar)	HIGH FLAME RETURN PRESSURE (bar)	LOW FLAME RETURN PRESSURE (bar)
BERGONZO A3	20	11 - 13	5 (recommended)
FLUIDICS WR2 nozzle /UNIGAS M3	25	See table below	7 (recommended)

FLUIDICS NOZZLE: REFERENCE DIAGRAM (INDICATIVE ONLY)

DIMENSIONS	FLOW RATE kg/h	
	Min	Max
40	13	40
50	16	50
60	20	60
70	23	70
80	26	80
90	30	90
100	33	100
115	38	115
130	43	130
145	48	145
160	53	160
180	59	180
200	66	200
225	74	225
250	82	250
275	91	275
300	99	300
330	109	330
360	119	360
400	132	400
450	148	450
500	165	500
550	181	550
600	198	600
650	214	650
700	231	700
750	250	750
800	267	800

Tab. 1

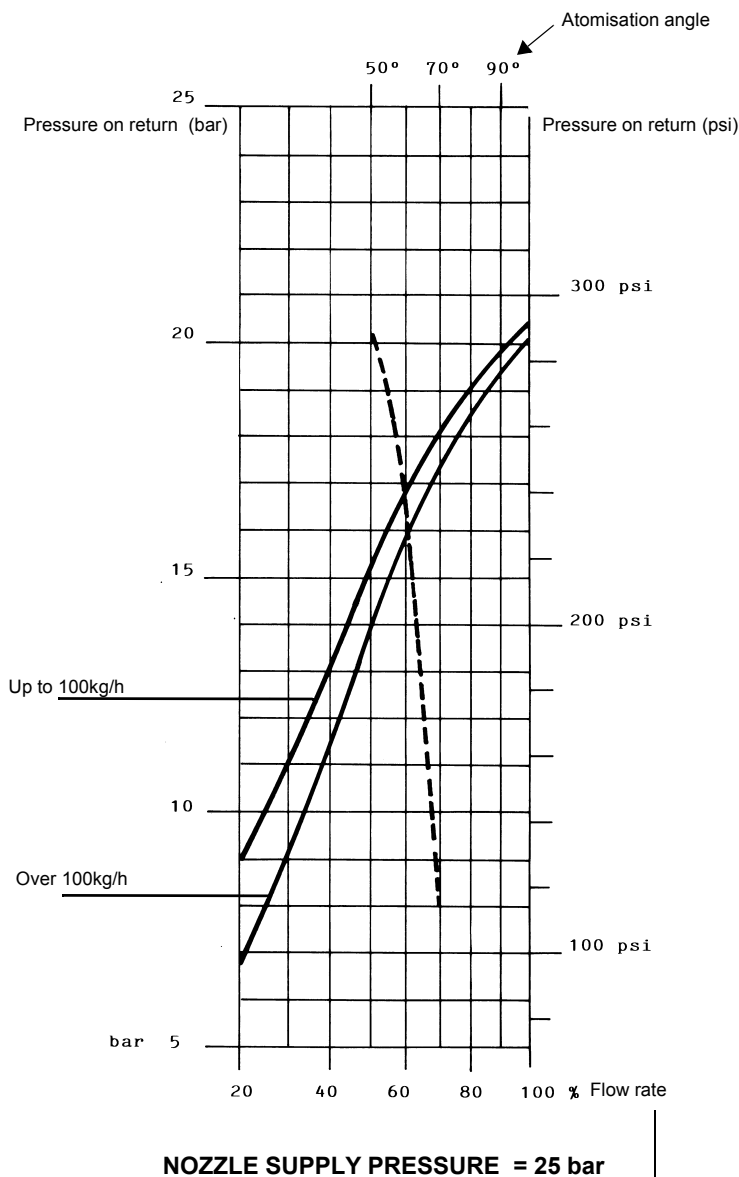

----- Atomisation angle according to the return pressure
 ——— % Flow rate
 viscosity at nozzle = 5 cSt



ATTENTION! To achieve the maximum flow rate close completely the return line.

Fig. 5

FLUIDICS KW3...60°

NOZZLE SUPPLY PRESSURE = 20 bar. VISCOSITY AT NOZZLE = 5 cSt

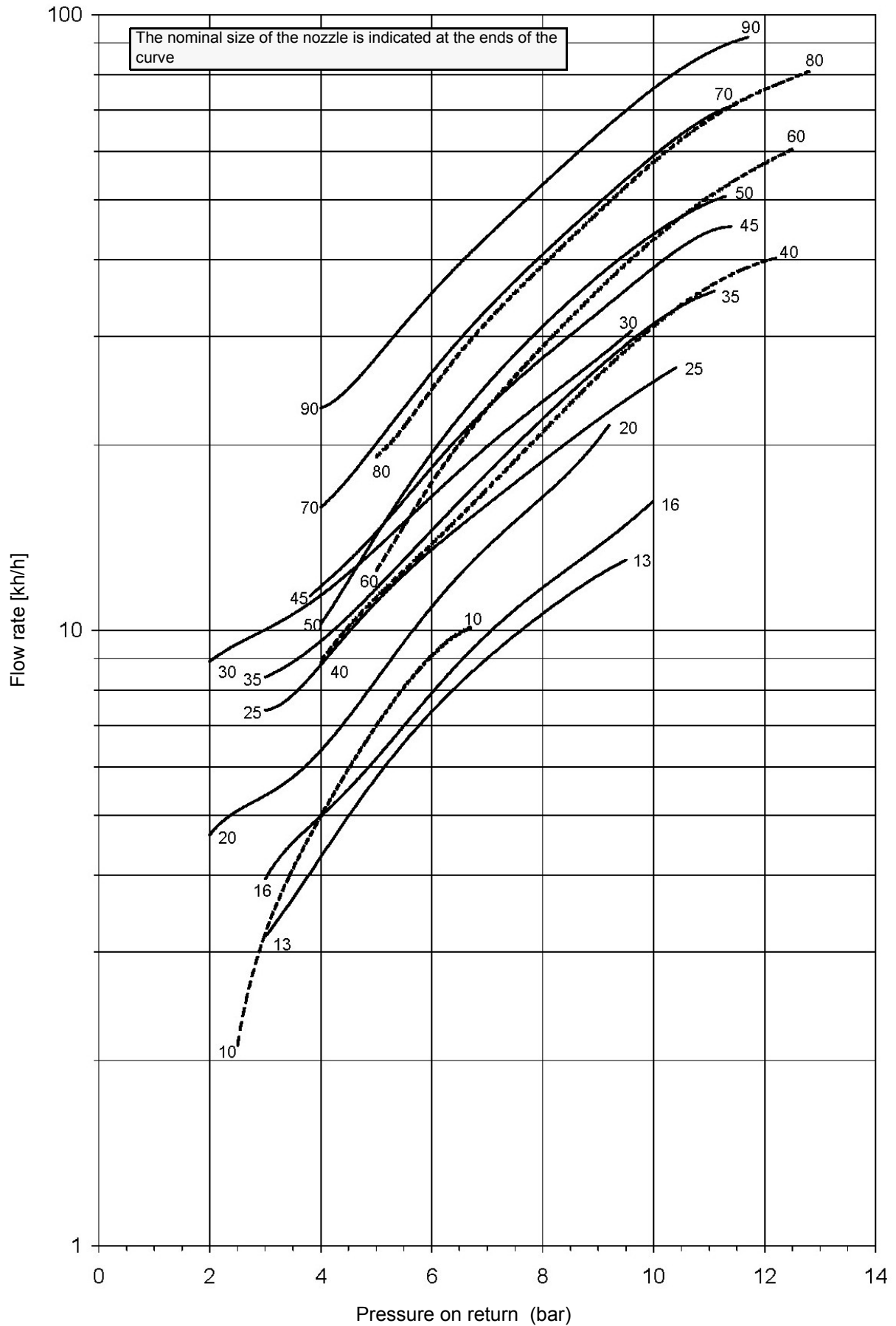

FLUIDICS KW3...60°

NOZZLE SUPPLY PRESSURE = 20 bar. VISCOSITY AT NOZZLE = 5 cSt

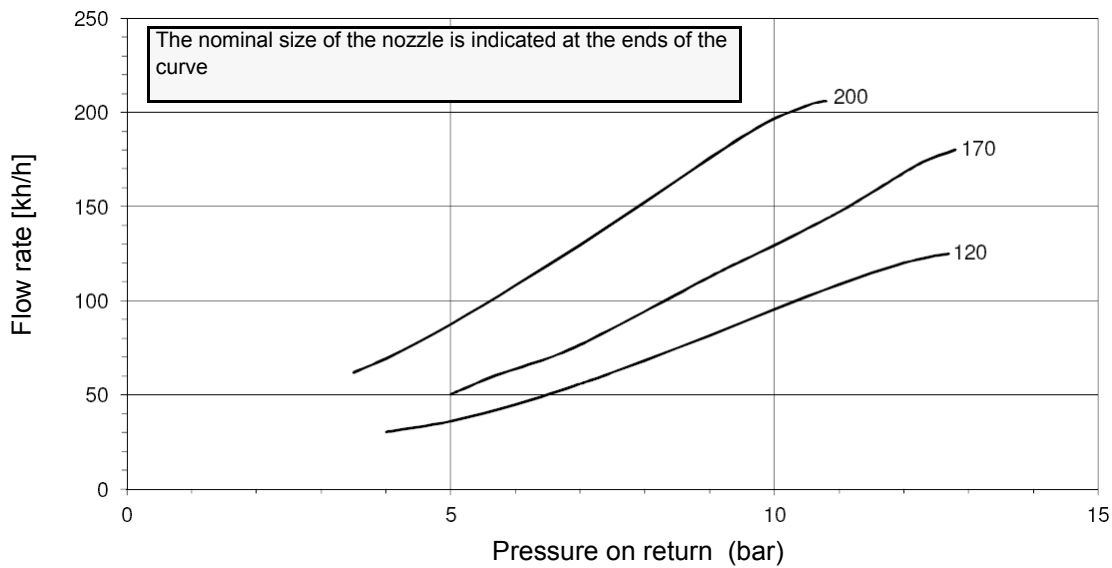
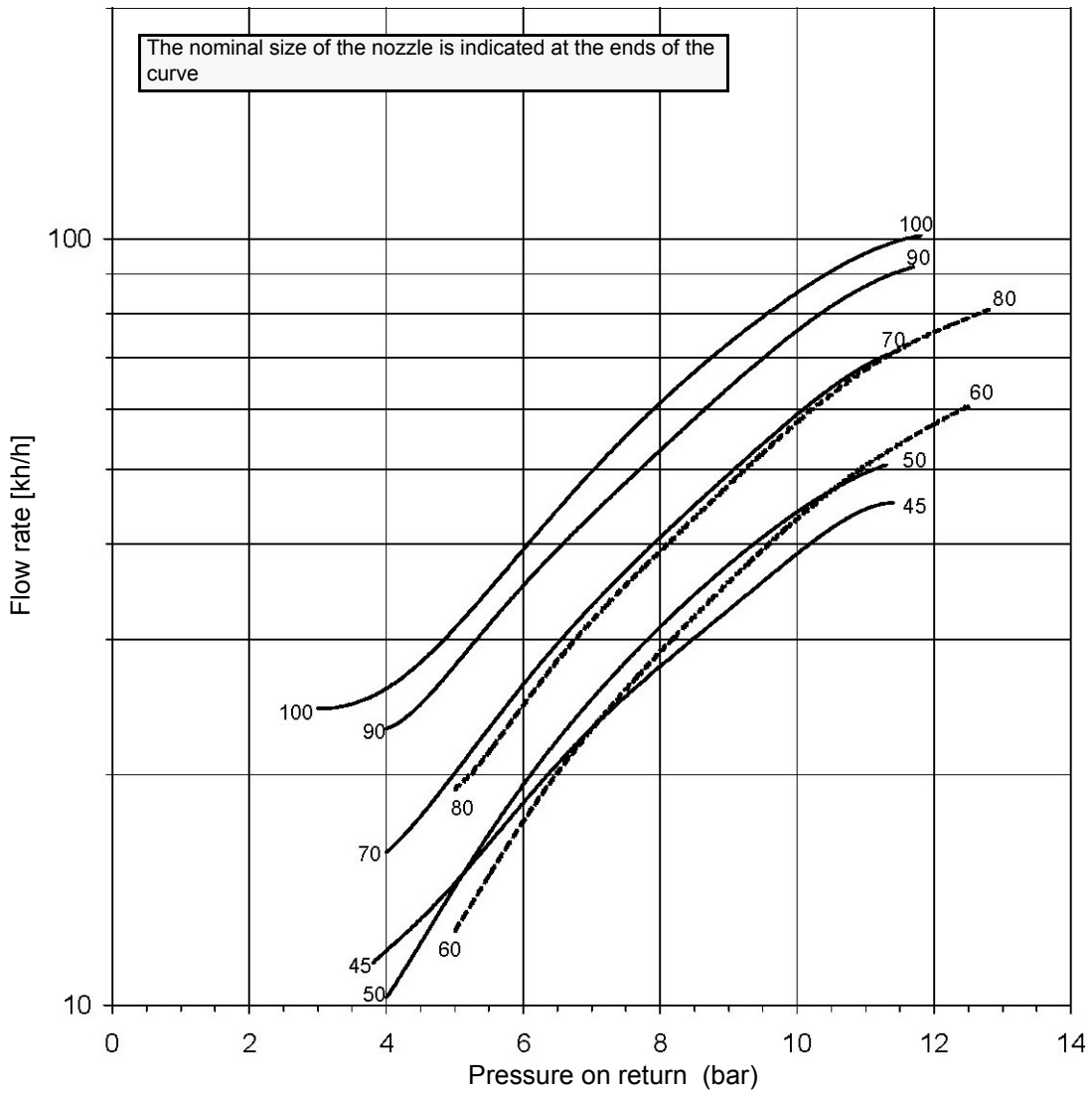

FLUIDICS KW3...60°

NOZZLE SUPPLY PRESSURE = 20 bar. VISCOSITY AT NOZZLE = 5 cSt

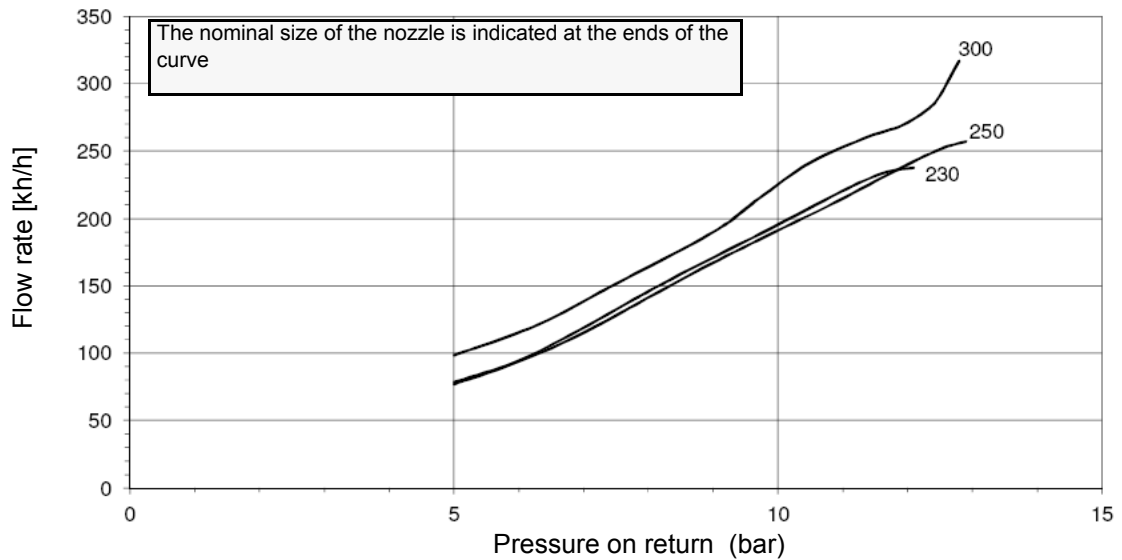
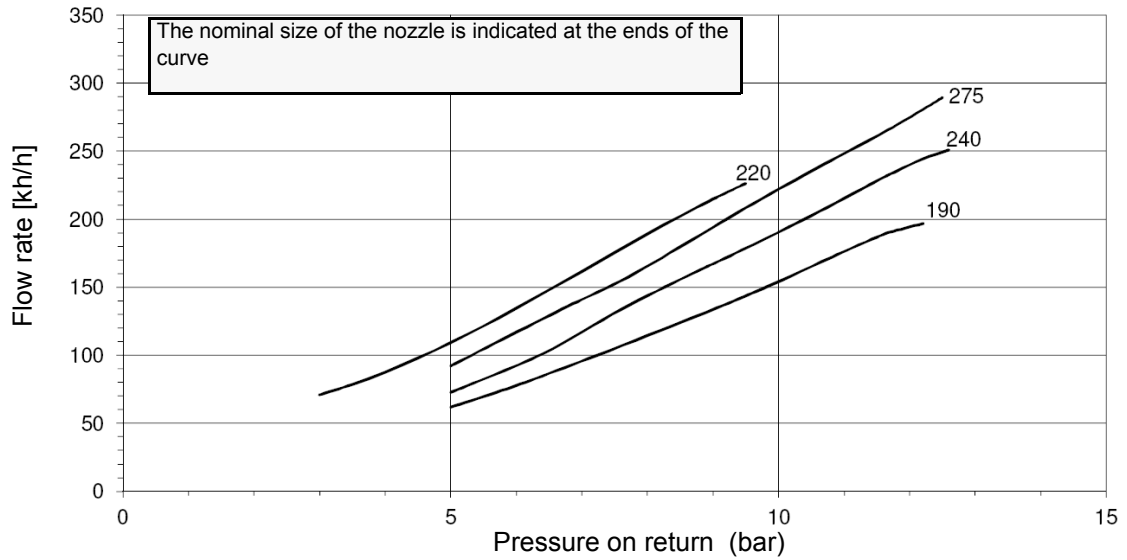
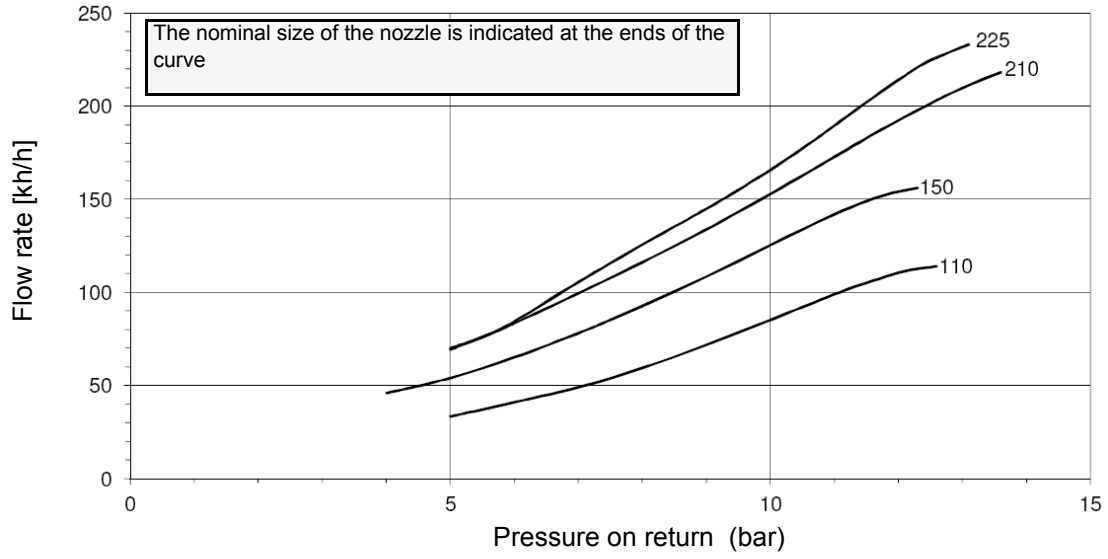

FLUIDICS KW3...45°

NOZZLE SUPPLY PRESSURE = 20 bar. VISCOSITY AT NOZZLE = 5 cSt

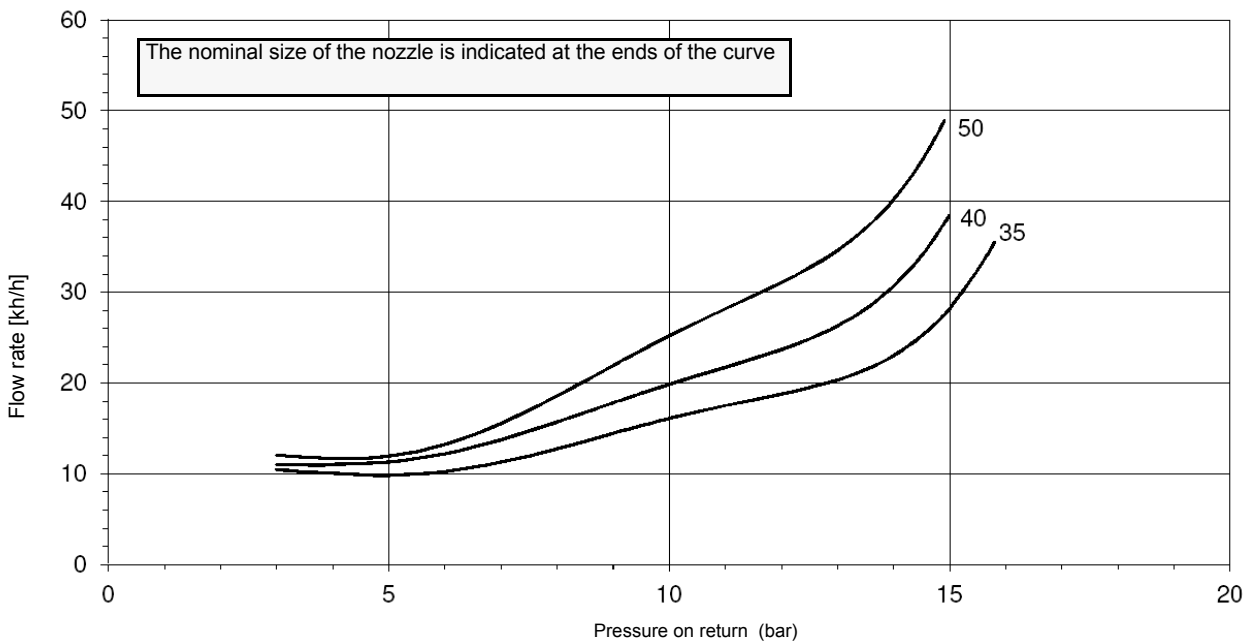
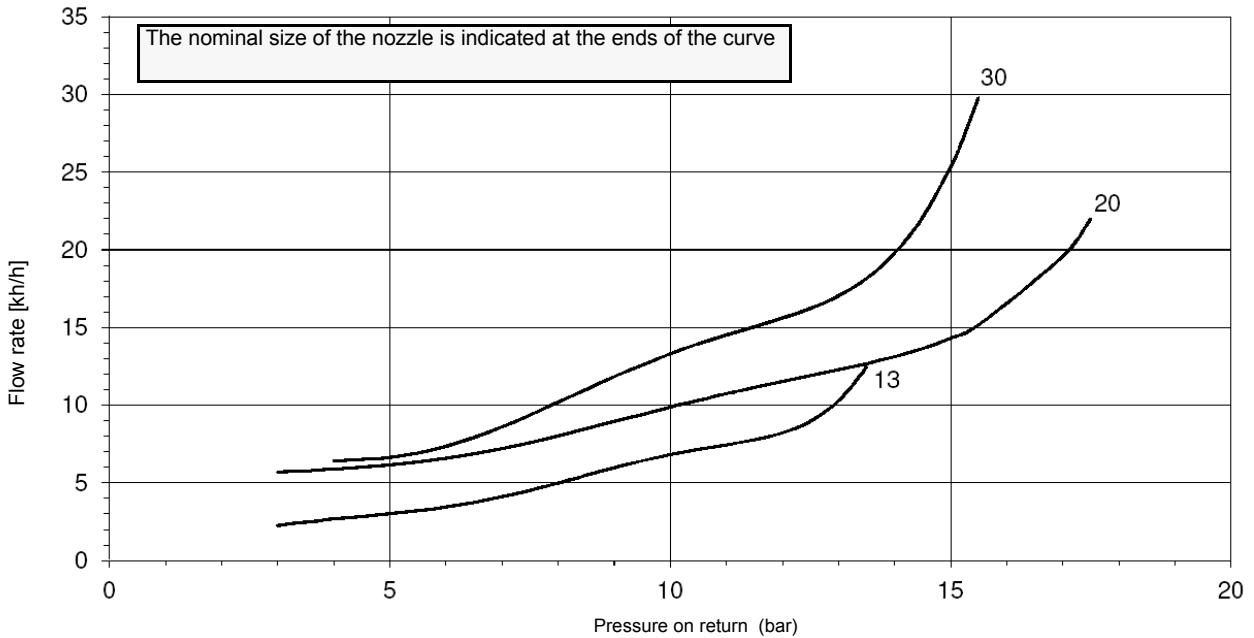
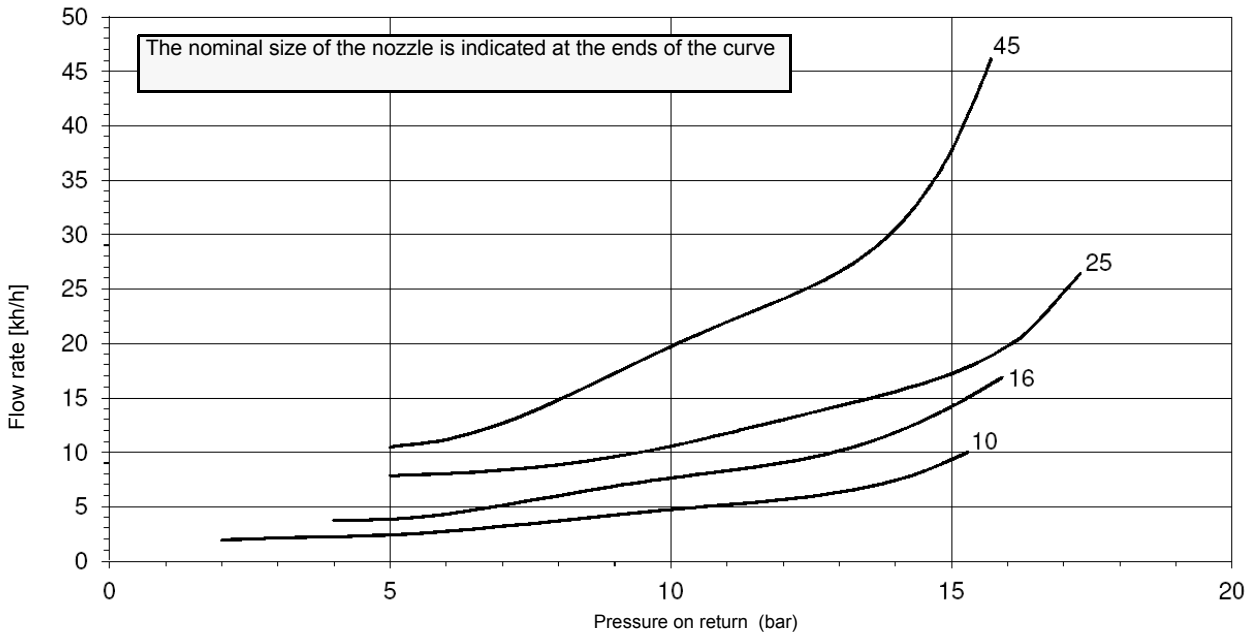

FLUIDICS KW3...45°

NOZZLE SUPPLY PRESSURE = 20 bar. VISCOSITY AT NOZZLE = 5 cSt

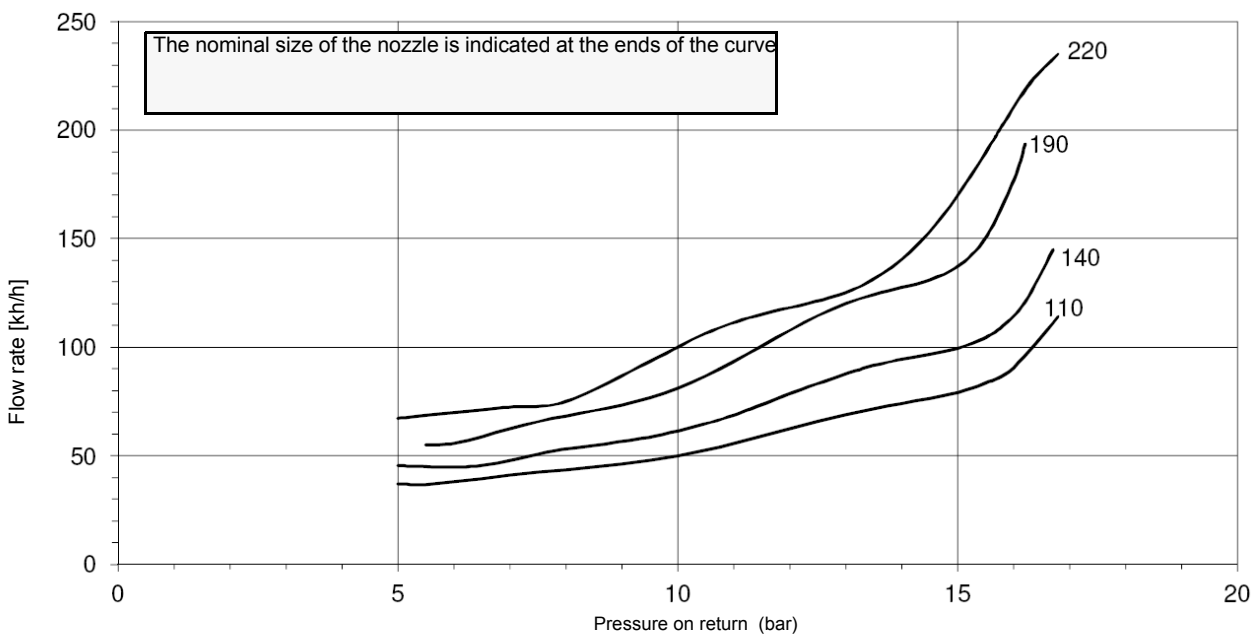
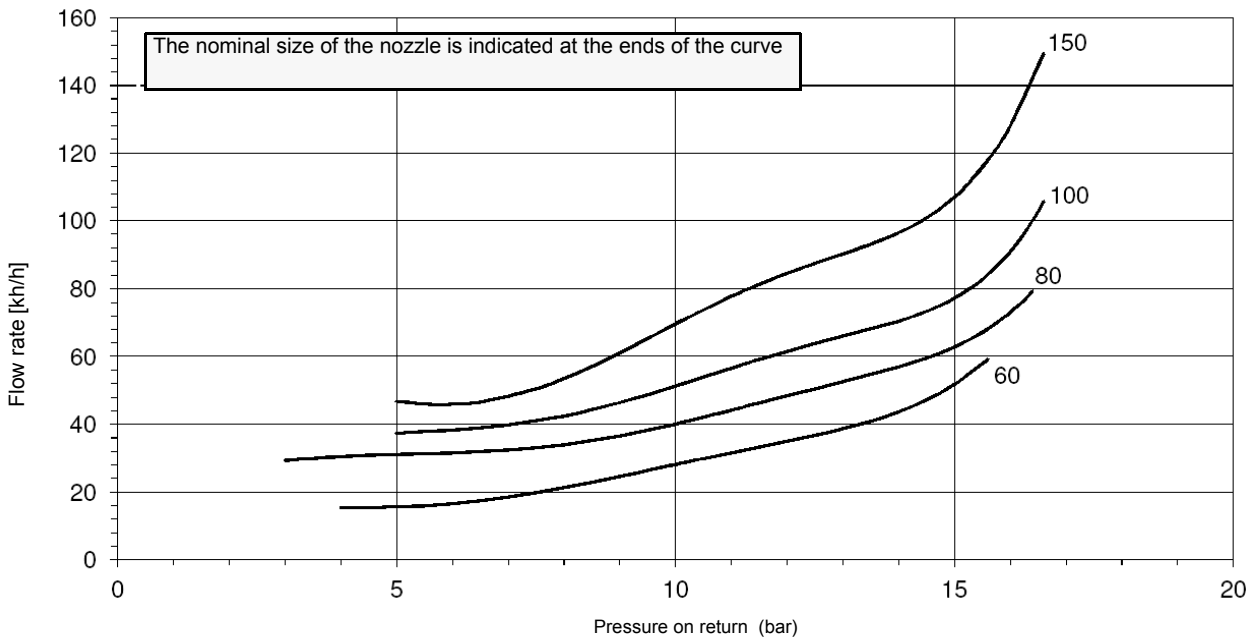
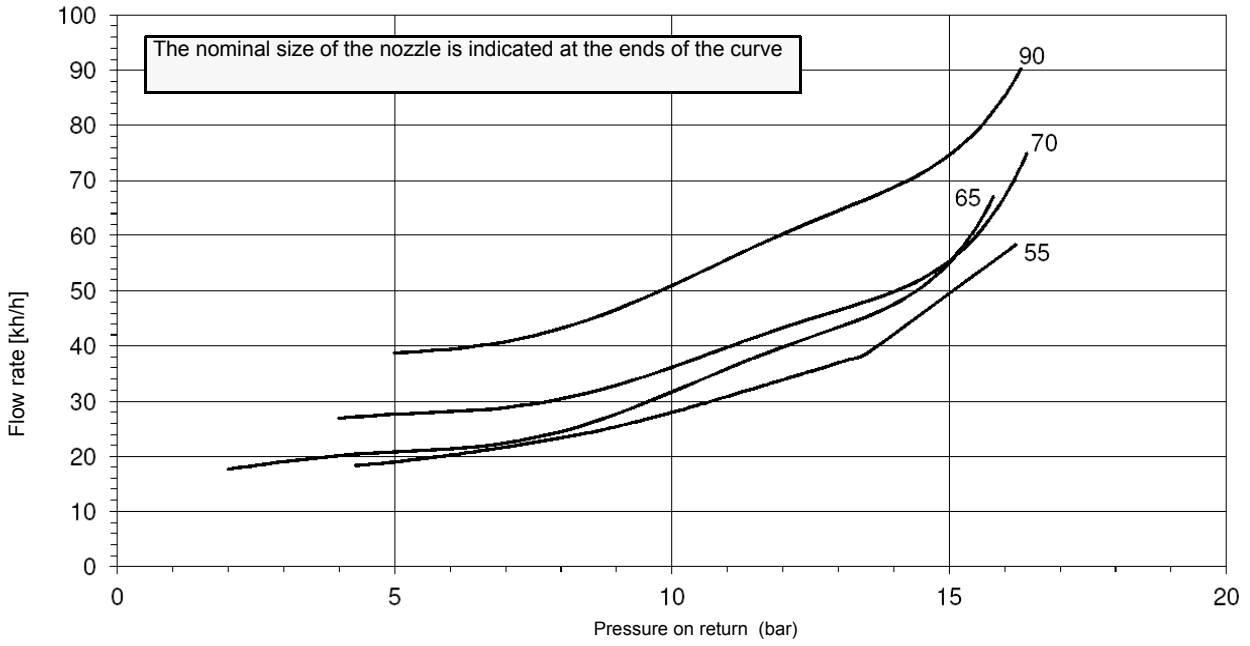

FLUIDICS KW3...45°

NOZZLE SUPPLY PRESSURE = 20 bar. VISCOSITY AT NOZZLE = 5 cSt

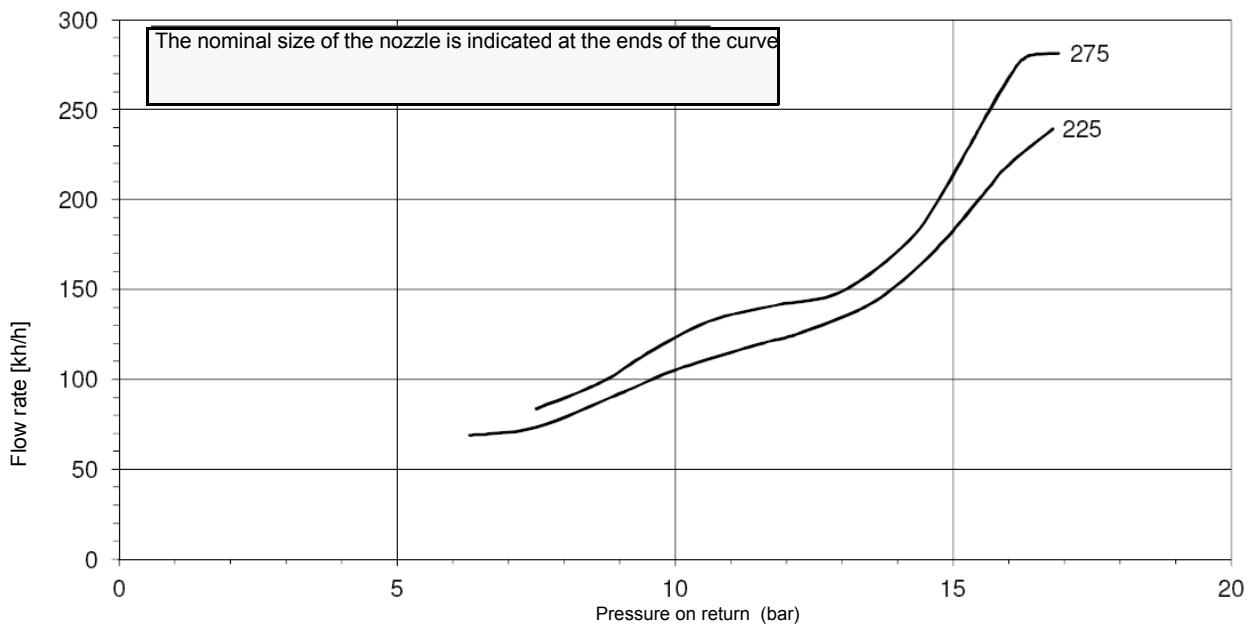
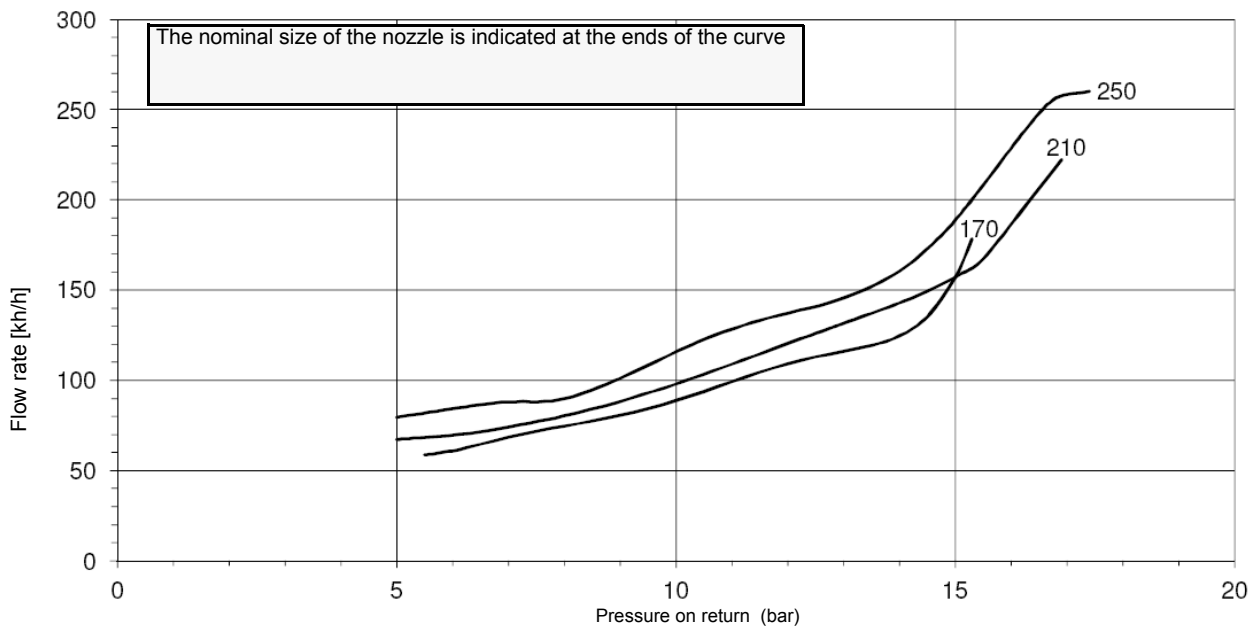
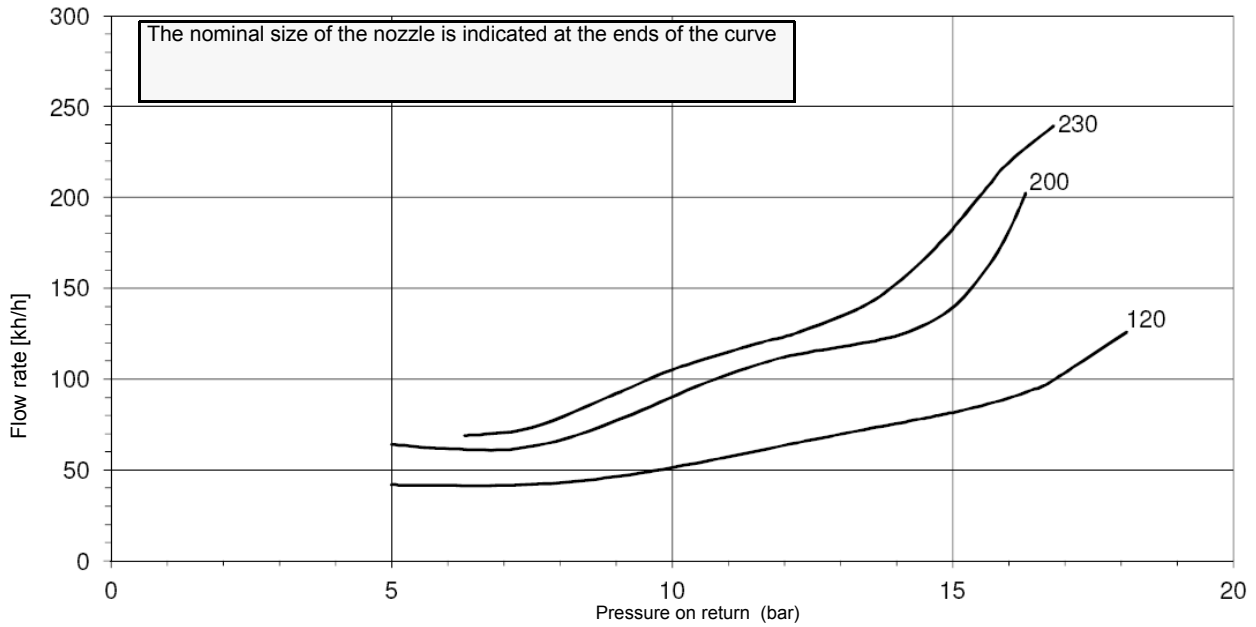

	ATTENTION: before starting the burner up, be sure that the manual cutoff valves are open. Be sure that the mains switch is closed.
	Before starting up the burner, make sure that the return pipe to the tank is not obstructed. Any obstruction would cause the pump seal to break.
	ATTENTION: During commissioning operations, do not let the burner operate with insufficient air flow (danger of formation of carbon monoxide); if this should happen, make the fuel decrease slowly until the normal combustion values are achieved.

	IMPORTANT! the combustion air excess must be adjusted according to the in the following chart:
---	---

Recommended combustion parameters		
<i>Fuel</i>	<i>Recommended (%) CO₂</i>	<i>Recommended (%) O₂</i>
Light oil	11.5 ÷ 13	2.9 ÷ 4.9

Adjustments - brief description

Adjust the air and fuel flow rates at the maximum output (“high flame”) first, by means of the air damper and the adjusting cam respectively.

- Check that the combustion parameters are in the suggested limits.
- .Check the nozzle flow rate.
- Then, adjust the combustion values corresponding to the points between maximum and minimum: set the shape of the adjusting cam foil. The adjusting cam sets the air/fuel ratio in those points, regulating the opening-closing of the fuel governor.
- Set, now, the low flame output, acting on the low flame microswitch of the actuator in order to avoid the low flame output increasing too much or that the flues temperature gets too low to cause condensation in the chimney.

Adjustment procedure

To change the burner setting during the testing in the plant, follow the next procedure, according to the actuator model provided (mod. Siemens SQM40.. Siemens SQL..).

Oil Flow Rate Settings by means Siemens SQM40.. actuator

- 1 with the electrical panel open, prime the oil pump acting directly on the related **CP** contactor (see next picture): check the pump motor rotation and keep pressing for some seconds until the oil circuit is charged; Check the fan motor rotation (see page 19).

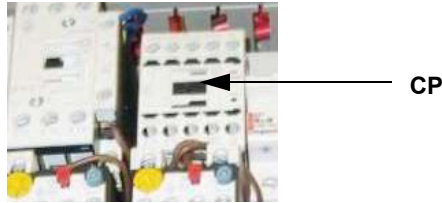

- 2 bleed the air from the **M** pressure gauge port (Fig. 6) by loosening the cap without removing it, then release the contactor.

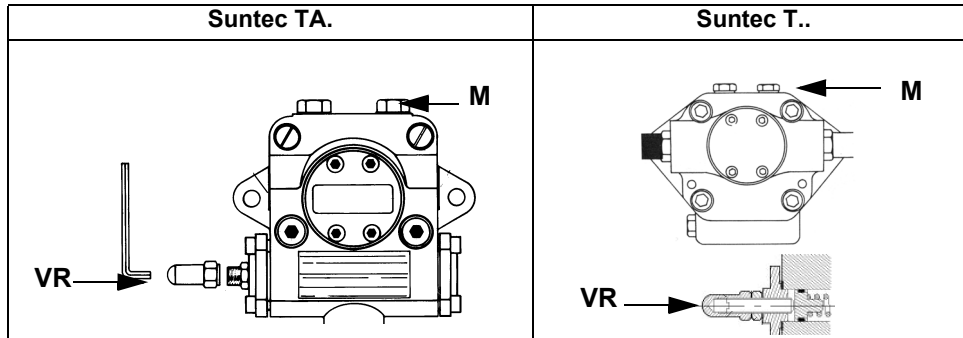
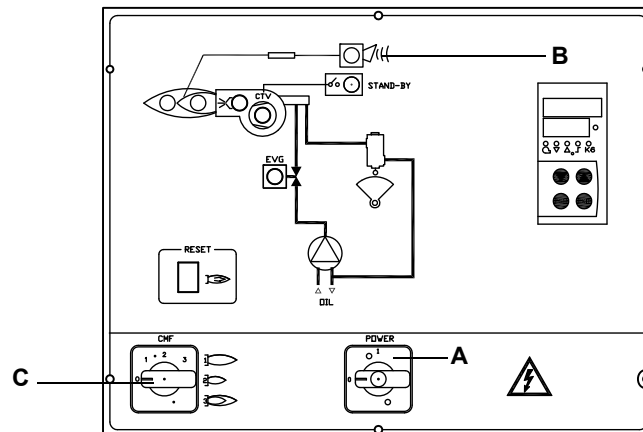

Fig. 6

- 3 Before starting the burner up, drive the high flame actuator microswitch matching the low flame one (in order to let the burner operates at the lowest output) to achieve safely the high flame stage .
- 4 Turn the burner on by means of its main switch **A**: if the burner locks (LED **B** on in the control panel) press the RESET button (**C**) on the control panel (see next picture) - see chapter "OPERATION" on page 33.



- 5 be sure that the actuator cam for the "Startup enabling signal" (when used) is about 5° more than the ignition cam;
- 6 ;start the burner up by means of the thermostat series and wait until the pre-purge time comes to an end;
- 7 drive the burner to high flame stage, by means for the thermostat **TAB** (as far as fully-modulating burners, see the related paragraph).
- 8 Then move progressively the microswitch to higher values until it reaches the high flame position; always check the combustion values and eventually adjusting the oil pressure (see next step).

SQM40.265 Actuator cams

Version with flame control LMO 24.255 / 44.255

- (RD) I High flame
- (BU) II Stand-by
- (OG) III Low flame
- (YE) IV -
- (BK) V -
- (GN) VI Advance stroke limitation cam - set +5° to cam (BU) II

Version with flame control LAL 2.25

- (RD) I High flame
- (BU) II Stand-by
- (OG) III Low flame
- (YE) IV -
- (BK) V -
- (GN) VI -

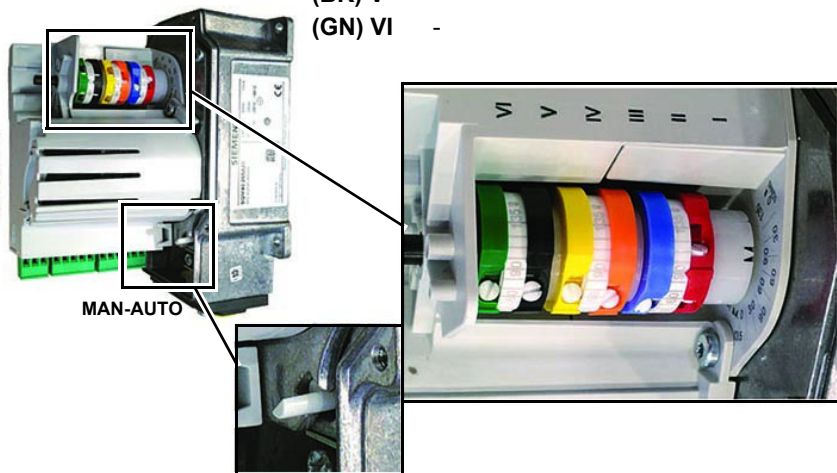
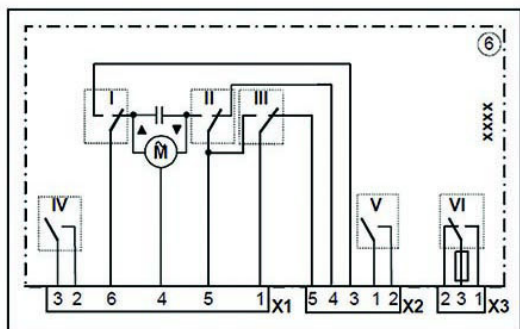

- 9 the nozzle supply pressure is already factory-set and must not be changed. Only if necessary, adjust the supply pressure as follows (see related paragraph); insert a pressure gauge into the port shown on Fig. 7 and act on on the pump adjusting screw **VR** (see Fig. 6) as to get the nozzle pressure at 25bar (Fluidics nozzles - see diagram on page 20).

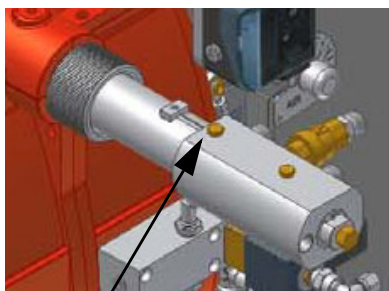

Pressure gauge port Pressure gauge port

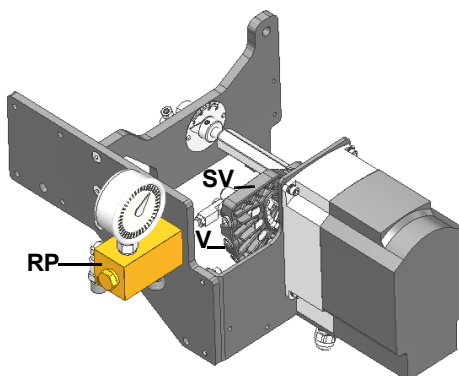
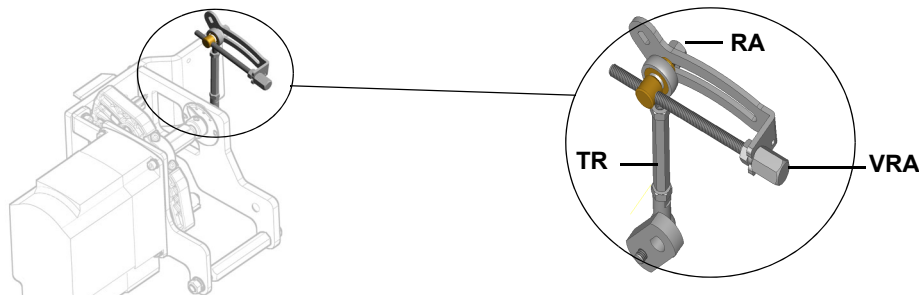

Fig. 8

Fig. 7

- 10 in order to get the maximum oil flow rate, adjust the pressure (reading its value on the **PG** pressure gauge) without changing the air flow rate set during the gas operation adjustments (see previous paragraph): checking always the combustion parameters, the adjustment is to be performed by means of the **SV** adjusting cam screw (see picture) when the cam has reached the high flame position.
- 11 To adjust the **air flow rate in the high flame stage**, loose the **RA** nut and screw **VRA** as to get the desired air flow rate: moving the rod **TR** towards the air damper shaft, the air damper opens and consequently the air flow rate increases, moving it far from the shaft the air damper closes and the air flow rate decreases.

Note: once the procedure is performed, be sure that the blocking nut **RA** is fasten. Do not change the position of the air damper rods.



- 12 Only if necessary, change the combustion head position: to let the burner operate at a lower output, loose the **VB** screw and move progressively back the combustion head towards the MIN position, by turning clockwise the **VRT** ring nut. Fasten **VB** screw when the adjustment is accomplished.

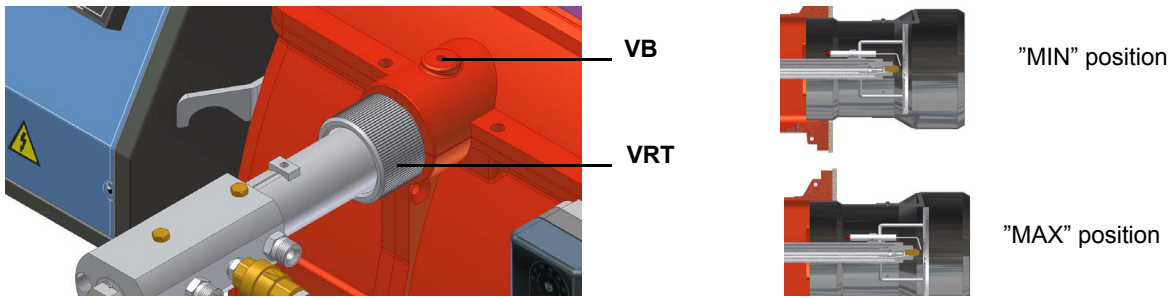

Attention! if it is necessary to change the head position, repeat the air and gas adjustments described above.

- 13 the air and oil rate are now adjusted at the maximum power stage, go on with the point to point adjustment on the **SV** adjusting cam as to reach the minimum output point.
- 14 as for the point-to-point regulation in order to set the cam foil shape, move the low flame microswitch (cam III) a little lower than the maximum position (90°);
- 15 set the **TAB** thermostat to the minimum in order that the actuator moves progressively towards the low flame position;
- 16 move cam III (low flame) towards the minimum to move the actuator towards the low flame until the two bearings find the adjusting screw that refers to a lower position: screw **V** to increase the rate, unscrew to decrease, in order to get the pressure as shown on diagram in Fig. 18, according to the requested rate.
- 17 Move again cam III towards the minimum to meet the next screw on the adjusting cam and repeat the previous step; go on this way as to reach the desired low flame point.
- 18 The low flame position must never match the ignition position that is why cam III must be set 20°- 30° more than the ignition position.

Turn the burner off; then start it up again. If the adjustment is not correct, repeat the previous steps.

Now adjust the pressure switch (see page 31).

Fully modulating burners

To adjust the fully-modulating burners, use the **CMF** switch on the burner control panel (see next picture), instead of the **TAB** thermostat as described on the previous paragraphs about the progressive burners. Go on adjusting the burner as described before, paying attention to use the CMF switch instead of **TAB**.

The **CMF** position sets the operating stages: to drive the burner to the high-flame stage, set CMF=1; to drive it to the low-flame stage, set CMF=2.

To move the adjusting cam set CMF=1 and then CMF=0. For further information about the regulating modulator, see the attached manual.

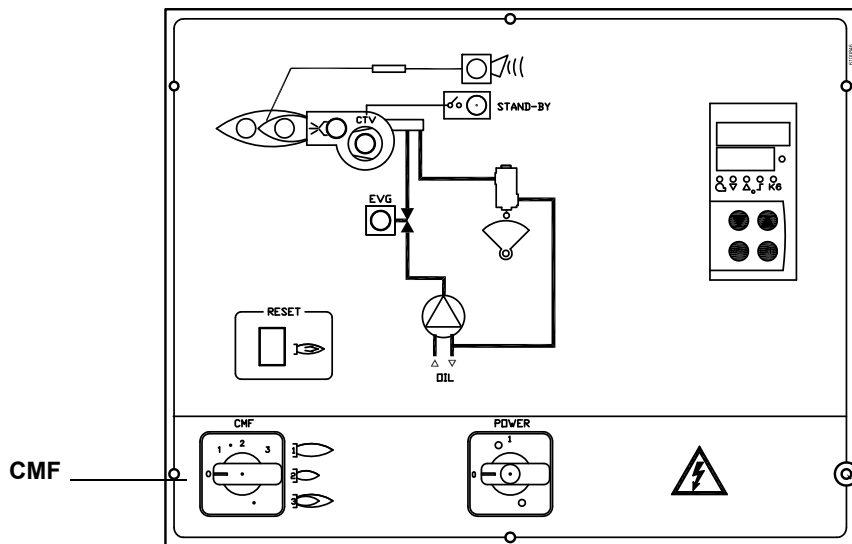

- CMF = 0 stop at current position
- CMF = 1 high flame operation
- CMF = 2 low flame operation
- CMF = 3 automatic operation

Calibration of air pressure switch (when provided)

To calibrate the air pressure switch, proceed as follows:

- Remove the transparent plastic cap.
- Once air and gas setting have been accomplished, startup the burner.
- During the pre-purge phase of the operation, turn slowly the adjusting ring nut **VR** in the clockwise direction until the burner lockout, then read the value on the pressure switch scale and set it to a value reduced by 15%.
- Repeat the ignition cycle of the burner and check it runs properly.
- Refit the transparent plastic cover on the pressure switch.



Minimum oil pressure switch (when provided)

The minimum oil pressure switch on the inlet line, checks that the pressure does not drop below a default value. The pressure switch must be set, say, at 10% under the pressure at the nozzle.

Maximum oil pressure switch

The oil pressure switch on the return line, checks that the pressure does not exceed a default value. This value must not be higher than the maximum acceptable pressure on the return line (this value is reported on the specification table). A pressure change on the return line could affect the combustion parameters: for this reason, the pressure switch must be set, say, at 20% over the pressure recorded during the combustion adjustment. The factory setting is 4 bar.

It is recommended to verify that the combustion parameters are within the range of acceptable values even against a pressure variation that gets close to the limit of the pressure switch.

This check should be carried out along the whole range of the burner output.

In case of unacceptable values, reduce from 20% to 15% the overpressure; later on, repeat the adjustments described above.

Oil pressure switch adjustment

Follow the below instruction, according to the pressure switch installed.

Trafag Picostat 9B4..

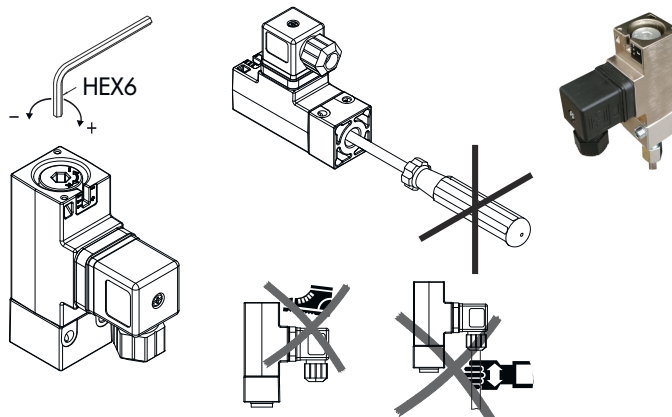

PART II: OPERATION

LIMITATIONS OF USE

THE BURNER IS AN APPLIANCE DESIGNED AND CONSTRUCTED TO OPERATE ONLY AFTER BEING CORRECTLY CONNECTED TO A HEAT GENERATOR (E.G. BOILER, HOT AIR GENERATOR, FURNACE, ETC.), ANY OTHER USE IS TO BE CONSIDERED IMPROPER AND THEREFORE DANGEROUS.

THE USER MUST GUARANTEE THE CORRECT FITTING OF THE APPLIANCE, ENTRUSTING THE INSTALLATION OF IT TO QUALIFIED PERSONNEL AND HAVING THE FIRST COMMISSIONING OF IT CARRIED OUT BY A SERVICE CENTRE AUTHORIZED BY THE COMPANY MANUFACTURING THE BURNER.

A FUNDAMENTAL FACTOR IN THIS RESPECT IS THE ELECTRICAL CONNECTION TO THE GENERATOR'S CONTROL AND SAFETY UNITS (CONTROL THERMOSTAT, SAFETY, ETC.) WHICH GUARANTEES CORRECT AND SAFE FUNCTIONING OF THE BURNER.

THEREFORE, ANY OPERATION OF THE APPLIANCE MUST BE PREVENTED WHICH DEPARTS FROM THE INSTALLATION OPERATIONS OR WHICH HAPPENS AFTER TOTAL OR PARTIAL TAMPERING WITH THESE (E.G. DISCONNECTION, EVEN PARTIAL, OF THE ELECTRICAL LEADS, OPENING THE GENERATOR DOOR, DISMANTLING OF PART OF THE BURNER).

NEVER OPEN OR DISMANTLE ANY COMPONENT OF THE MACHINE.

OPERATE ONLY THE MAIN SWITCH, WHICH THROUGH ITS EASY ACCESSIBILITY AND RAPIDITY OF OPERATION ALSO FUNCTIONS AS AN EMERGENCY SWITCH, AND ON THE RESET BUTTON.

IN CASE OF A BURNER SHUT-DOWN, RESET THE CONTROL BOX BY MEANS OF THE RESET PUSHBUTTON. IF A SECOND SHUT-DOWN TAKES PLACE, CALL THE TECHNICAL SERVICE, WITHOUT TRYING TO RESET FURTHER.

WARNING: DURING NORMAL OPERATION THE PARTS OF THE BURNER NEAREST TO THE GENERATOR (COUPLING FLANGE) CAN BECOME VERY HOT, AVOID TOUCHING THEM SO AS NOT TO GET BURNT.

OPERATION



ATTENTION: before starting the burner up, be sure that the manual cutoff valves are open. Be sure that the mains switch is closed.

- 1 Set to the ON position the switch A on the control panel of the burner.
- 2 Check the control box is not in the lockout position (light B must be off); in such a case reset it by the reset pushbutton C.
- 3 Check that the series of thermostats (or pressure switches) enables the burner to operate.
- 4 The startup sequence begins: the control box ignites the fan motor and energises the ignition transformer as well (signalled by the light H on the burner control panel).
- 5 At the end of the pre-purge stage, the light oil solenoid valve EVG1 is energised (signalled by the lamp G on the control panel) and the burner is on.
- 6 The ignition transformer is energized for few seconds after the ignition of the flame (post-ignition time) and at the end of this time is de-energised (light H off).
- 7 After the ignition the actuator moves to the high flame position for some seconds, then the operation begins and the burner switches to high flame or to low flame, according to the plant demand.
- 8 The high/low flame operation is shown by the F LED turning on/off.

Burner control panel

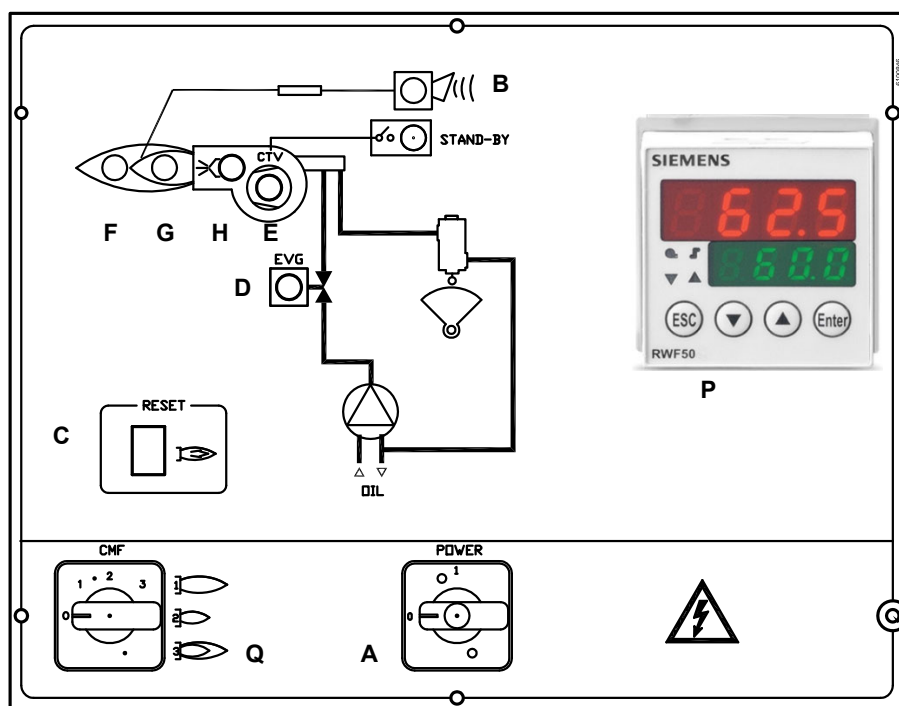

Fig. 9

Keys

- A ON-OFF main switch
- B Lockout signalling lamp
- C Control box release pushbutton
- D Signalling lamp for light oil solenoid valve opening
- E Thermal cutout intervention signalling lamp
- F High flame operation signalling lamp
- G Low flame operation signalling lamp
- H Ignition transformer operation signalling lamp
- P Siemens modulator
- Q Manual operation mode switch

PART III: MAINTENANCE

At least once a year carry out the maintenance operations listed below. In the case of seasonal servicing, it is recommended to carry out the maintenance at the end of each heating season; in the case of continuous operation the maintenance is carried out every 6 months.



WARNING: ALL OPERATIONS ON THE BURNER MUST BE CARRIED OUT WITH THE MAINS DISCONNECTED AND THE FUEL MANUAL CUTOFF VALVES CLOSED!
ATTENTION: READ CAREFULLY THE "WARNINGS" CHAPTER AT THE BEGINNING OF THIS MANUAL.

ROUTINE MAINTENANCE

- Check and clean the cartridge of the fuel filter, replace it if necessary (see next paragraph);
- carefully check the fuel flexible hoses for leaks;
- check and clean the filter on the fuel pump: filter must be thoroughly cleaned at least once in a season to ensure correct working of the fuel unit. To remove the filter, unscrew the four screws on the cover. When reassemble, make sure that the filter is mounted with the feet toward the pump body. If the gasket between cover and pump housing should be damaged, it must be replaced;
- remove, check and clean the combustion head (page 35); when reassembling, carefully observe the measures on page 36;
- check the ignition electrodes and their ceramic insulators, clean, adjust and replace if necessary page 36;
- remove and clean the oil nozzles (IMPORTANT: do not clean the nozzles using metallic or sharp utensils, use only solvents or steam); at the end of maintenance operations, refit the burner, turn it on and check the combustion. If in doubt, replace the defective nozzle/s. In case of intensive use of the burner, the nozzles must be replaced at the end of the working season;
- check and carefully clean the flame detection photoresistor, if necessary replace it and, if in doubt, check the detection current following the scheme in Fig. 11;
- clean and grease levers and rotating parts.



Technical procedure of self cleaning filters substitution (valid for all models)

- 1 Close the bowl valve before the self cleaning filter
- 2 Switch off any electrical equipment on board on the filter (example motorization or heaters)



WARNING! Drain the system by unscrewing the drain screw on the bottom of the self cleaning filter

- 3 Disconnect the outlet pipe from the cover of the self cleaning filter
- 4 Remove the cover with all the filter pack, leaving only the bowl on the line
- 5 Clean any residue on the bottom of the bowl and clean the seat of the O-ring seal



WARNING! Replace the O-ring seal between the bowl and cover

- 6 Insert the filter pack again making sure to respect the correct inlet/outlet direction or any references on the cover and tray
- 7 Replace the filter by following the reverse order operations
- 8 Make sure there is no leakage and give the power to any electrical equipments on the filter

Removing the combustion head

- 1 Remove the top cover **C**;
- 2 remove the photoresistor from its seat;
- 3 unscrew the revolving connectors (**E** in figure) on the fuel pipes (use 2 spanners to avoid loosening the connections attached to the distributor block);
- 4 loosen **VRT** screw to free the threaded rod **AR**, then screw out the 2 screws **V** holding the washer **R** and the screw **VRT** again;
- 5 remove the whole assembly as shown in figure;
- 6 clean the combustion head by means of a vacuum cleaner; to scrape off the scale use a metallic brush.

Note: to replace the combustion head reverse the procedure described above.

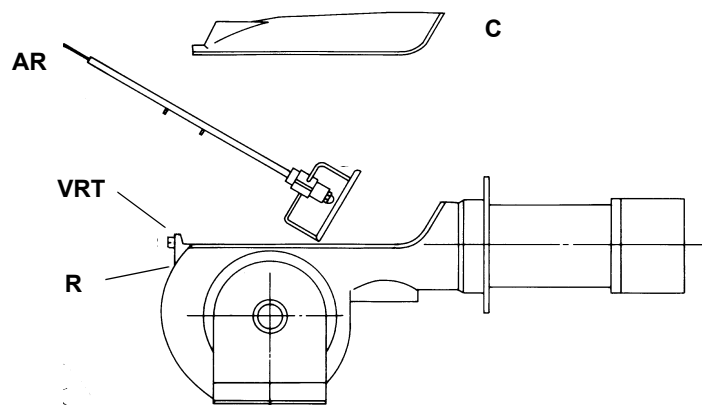

Removing the oil gun

Once the combustion head is removed, as described before, remove the oil gun as follows:

- 1 unscrew the connectors from the oil pipes (**E** in figure) using 2 spanners to avoid loosening the connections attached to the distributor block);
- 2 loosen the screw **VB**
- 3 remove the gun with the light oil nozzle holder.
- 4 clean the oil gun by means of a vacuum cleaner; to scrape off the scale use a metallic brush
- 5 replace the oil gun, if necessary.

Note: To re-assemble, follow the procedure above in reversed order.

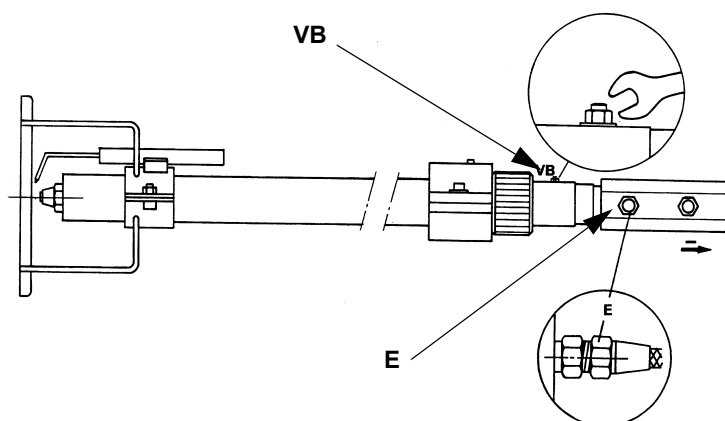

Correct position of electrodes and combustion head



ATTENTION: avoid the ignition electrodes to get in touch with metallic parts (blast tube, head, etc.), otherwise the boiler's operation would be compromised. Check the electrodes position after any intervention on the combustion head.

To guarantee a good ignition the measures (in mm) shown on the next pictures must be observed. Be sure to tight the screw on the electrodes group before reassembling the combustion head.

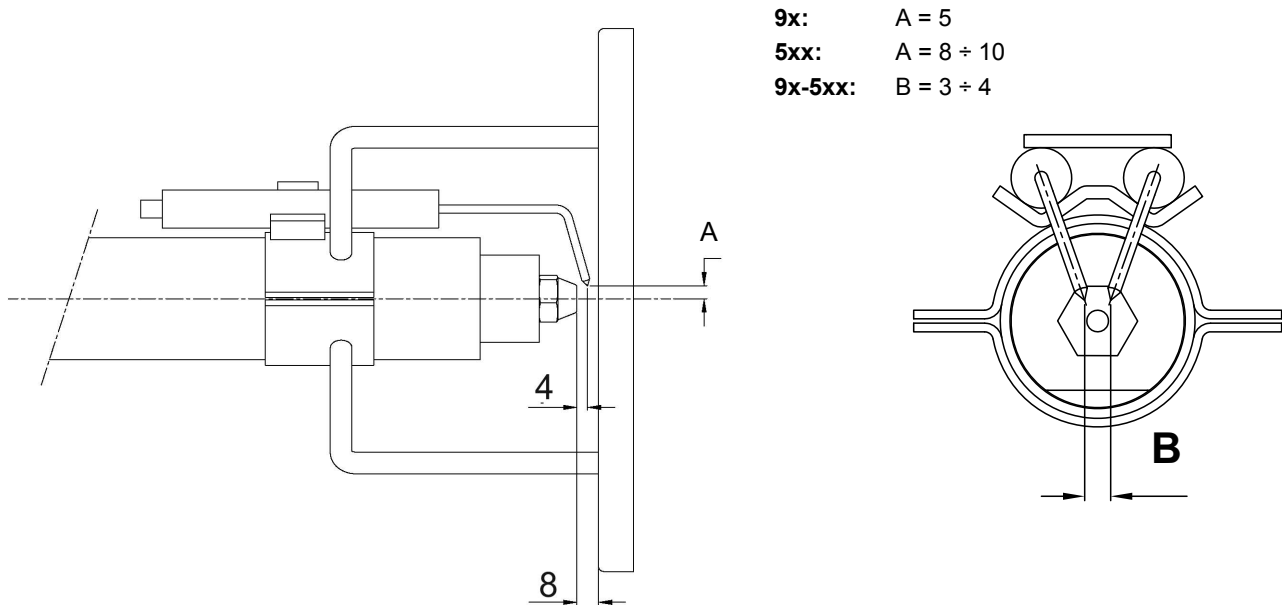

9x: A = 5
5xx: A = 8 ÷ 10
9x-5xx: B = 3 ÷ 4

Fig. 10

Replacing the ignition electrodes



ATTENTION: avoid the ignition electrodes to get in touch with metallic parts (blast tube, head, etc.), otherwise the boiler's operation would be compromised. Check the electrodes position after any intervention on the combustion head.

To replace the ignition electrodes, proceed as follows:

- 1 remove the burner cover;
- 2 disconnect the electrodes cables;
- 3 remove the combustion head (see par. "Removing the combustion head");
- 4 loose screw (B) that fasten the ignition electrodes;
- 5 remove the electrodes and replace them, referring to the values quoted on Fig. 10.

Cleaning and replacing the detection photoresistor

When cleaning the photoresistive detector, always use a clean cloth. If necessary, remove it from its slot to replace it. When cleaning the photoresistive detector, always use a clean cloth. If necessary, remove it from its slot to replace it.

Checking the detection current

To measure the detection signal follow the diagram in Fig. 11. If the signal is not in the advised range, check the electrical contacts, the cleaning of the combustion head, the position of the photoresistor and if necessary replace it.

series 9x: LMO

series 5xx: LAL25

Minimum current intensity with flame

LMO: 45 μ A

LAL25: 8 μ A

Maximum current intensity without flame:

LMO: 5.5 μ A

LAL25: 0.8 μ A

Maximum possible current intensity with flame:

LMO: 100 μ A

LAL25: 30 μ A

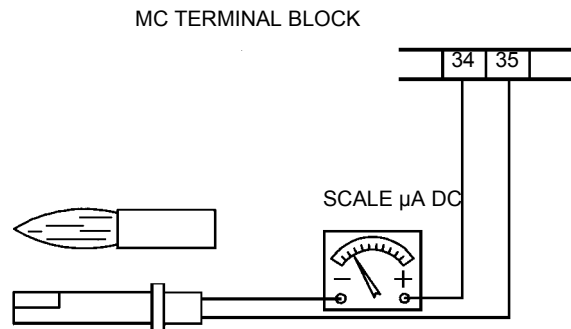

Fig. 11

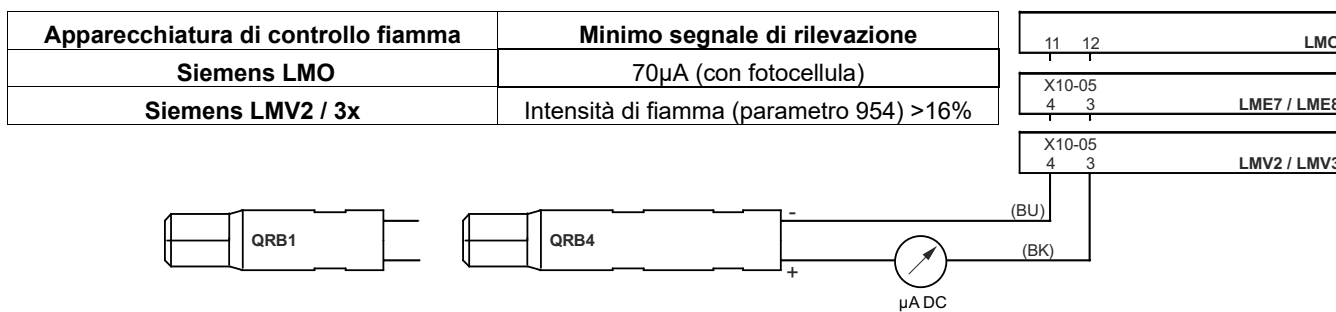

Fig. 12: Rilevazione con fotocellula QRB4 - QRB1

Termine di servizio del bruciatore

- In condizioni ottimali di funzionamento, e con una manutenzione preventiva, la durata di vita del bruciatore può arrivare a 20 anni.
- All scadenza del termine di servizio del bruciatore è necessario effettuare una diagnosi tecnica e in caso di necessità, eseguire una riparazione complessiva.
- Lo stato del bruciatore viene considerato al limite se è tecnicamente impossibile continuare a utilizzarlo a causa della non conformità ai requisiti di sicurezza oppure a causa del calo di prestazioni.
- Il proprietario prende la decisione se terminare l'impiego del bruciatore, oppure la sostituzione e lo smaltimento in base allo stato effettivo dell'apparecchio e alle eventuali spese di riparazione.
- L'utilizzo del bruciatore per altri scopi oltre la scadenza dei termini di utilizzo è severamente vietato.

Fermo stagionale

Per spegnere il bruciatore nel periodo di fermo stagionale, procedere nel modo seguente:

- 1 portare l'interruttore generale del bruciatore in posizione 0 (OFF - spento)
- 2 staccare la linea di alimentazione elettrica
- 3 chiudere il rubinetto del combustibile della linea di distribuzione.

Smaltimento del bruciatore

In caso di rottamazione del bruciatore, seguire le procedure previste dalle leggi vigenti sullo smaltimento dei materiali.

SCHEMI ELETTRICI

Consultare gli schemi elettrici allegati.

ATTENZIONE

- 1 - Alimentazione elettrica 230V / 400V 50Hz 3N a.c.
- 2 - Non invertire fase con neutro
- 3 - Assicurare una buona messa a terra del bruciatore

TROUBLESHOOTING GUIDE - Light oil operation

BURNER DOESN'T LIGHT	* No electric power supply	* Wait for electric power supply is back
	* Main switch open	* Close the switch
	* Thermostats open	* Check set points and thermostat connections
	* Bad thermostat set point or broken thermostat	* Set or replace the thermostat
	* No gas pressure	* Restore gas pressure
	* Safety devices (manually operated safety thermostat or pressure switch, and so on ...) open	* Restore safety devices; wait that boiler reaches its temperature then check safety device functionality.
	* Broken fuses	* Replace fuses. Check current absorption
	* Fan thermal contacts open (only three phases)	* Reset contacts and check current absorption
	* Burner control locked out	* Reset and check its functionality
	* Burner control damaged	* Replace burner control
BURNER LOCKS OUT WITH FLAME PRESENCE	* Flame detector dirty or damaged	* Clean or replace flame detector
	* Burner control damaged	* Replace burner control
	* Smoking flame	* Reset combustion air flow rate * Check the nozzle and, if necessary, replace it * Check cleanness of combustion head * Check chimney suction * Check boiler cleanness
	* Combustion head dirty	* Clean combustion head
BURNER LOCKS OUT WITHOUT ANY FUEL FLOW RATE	* No fuel	* Fill the tank
	* Pump joint broken	* Check pump pressure
	* Pump damaged	* Check pump suction * Replace pump
	* Compressed air (or steam) too high	* Released compressed air (or steam) pressure
	* Oil metering valve not open far enough	* Check air pressure * Check servomotor position
	* Oil valve not energized	* Check wiring path or replace valve
	* Fan motor not efficient	* Adjust or replace the motor
	* Fan or pump motor runs in the wrong way	* Change rotation
	* Obstructed nozzle	* Clean or replace the nozzle
	* Check valve in the tank locked or leaking	* Clean or replace the valve
	* Oil filter dirty	* Clean filter
	* Pump filter dirty	
	* Solenoid valve dirty or broken	* Clean or replace solenoid valve
BURNER LOCKS OUT WITH FUEL FLOW RATE (NO FLAME)	* Oil pressure too low	* Reset oil pressure
	* Nozzle dirty or damaged	* Clean or replace nozzle
	* Water in the tank	* Take off all the water from the tank * Clean all filters
	* Suction too high	* Check suction before pump. If necessary clean filters.
	* Ignition electrodes grounded because dirty or damaged	* Clean or replace electrodes
	* Ignition electrodes badly set	* Check electrodes position referring to instruction manual
	* Cables damaged	* Replace cables
	* Bad position of cables in the ignition transformer or into the electrodes	* Improve the installation
	* Ignition transformer damaged	* Replace the transformer
PUMP TOO NOISY	* Suction too high (over 0,35 bar) (dirty filters, check valve in the tank locked, and so on ...)	* Clean filters * Replace check valve in the tank
	* Flexible hoses damaged	* Replace flexible hoses
	* Air infiltration in the pipes	* Take off all infiltration
	* Pipe too long or too narrow	* Increase line size
BURNER RUMBLES WHEN MODULATING TO HIGH FIRE	* Burner is too lean	* Adjust air-oil ratio
	* Drawer assembly not set properly	* Check drawer position
	* Oil may be too hot	* Check oil temperature
	* Flame is blowing off head	* Check head position
CARBON BUILD-UP ON THE FIRESIDES OF THE BOILER	* Oil flame not retaining to head	
	* Dirty nozzle	* Clean the nozzle
	* Oil spray impinging on burner head	* Check position of the nozzle respect to the head
FLAME IRREGULAR OR SPARKING	* Spray angle of the nozzle too wide	* Reduce spray angle
	* Oil pressure at nozzle too low	* Reset oil pressure
	* Air flow rate too high	* Adjust air flow rate
	* Oil is too cold	* Adjust oil temperature
	* Dirt in the oil	* Check filters
	* Water in the fuel	* Take off all the water
	* Oil impingement on the combustion head	* Drawer assembly far too rear * Nozzle is not protruding through centerhole of air diffuser * Oil flame not retaining to the head
	* Nozzle dirty or damaged	* Clean or, if necessary, replace the nozzle
BURNER LIGHTS BUT FLAME DOESN'T RETAIN TO BURNER HEAD	* Drawer assembly not positioned correctly	* Move forward or backward
	* Nozzle too far forward through centerhole of diffuser	* Move nozzle backward respect to diffuser
	* Oil or air pressure at nozzle is too low	* Increase oil or air pressure
	* Air louver too open	* Reduce air louver opening
	* Too much spread between oil and air (or steam) pressure	* Set the spread to a proper value
FLAME IRREGULAR OR SMOKING	* Not enough combustion air	* Adjust air flow rate
	* Nozzle dirty or damaged	* Clean or, if necessary, replace the nozzle
	* Flame is too big for furnace or nozzle spray angle is wrong	* Check burner-furnace coupling * Change nozzle with a suitable one
	* Nozzle spray angle wrong (flame too long or too wide)	* Replace nozzle
	* Boiler dirty	* Clean the boiler
	* Not enough suction at chimney	* Check chimney cleanness or size
	* Pressure at nozzle too low	* Reset oil pressure
	* Oil too cold	* Reset oil temperature
	* Combustion air inlet dirty	* Clean the air inlet
	* Flame is too small respect to furnace volume	* Replace nozzle or reset pump pressure
FUEL GAS TEMPERATURE TOO HIGH	* Boiler dirty	* Clean the boiler
	* Oil flow rate too high	* Adjust oil pressure or replace nozzle

BURNER EXPLODED VIEW

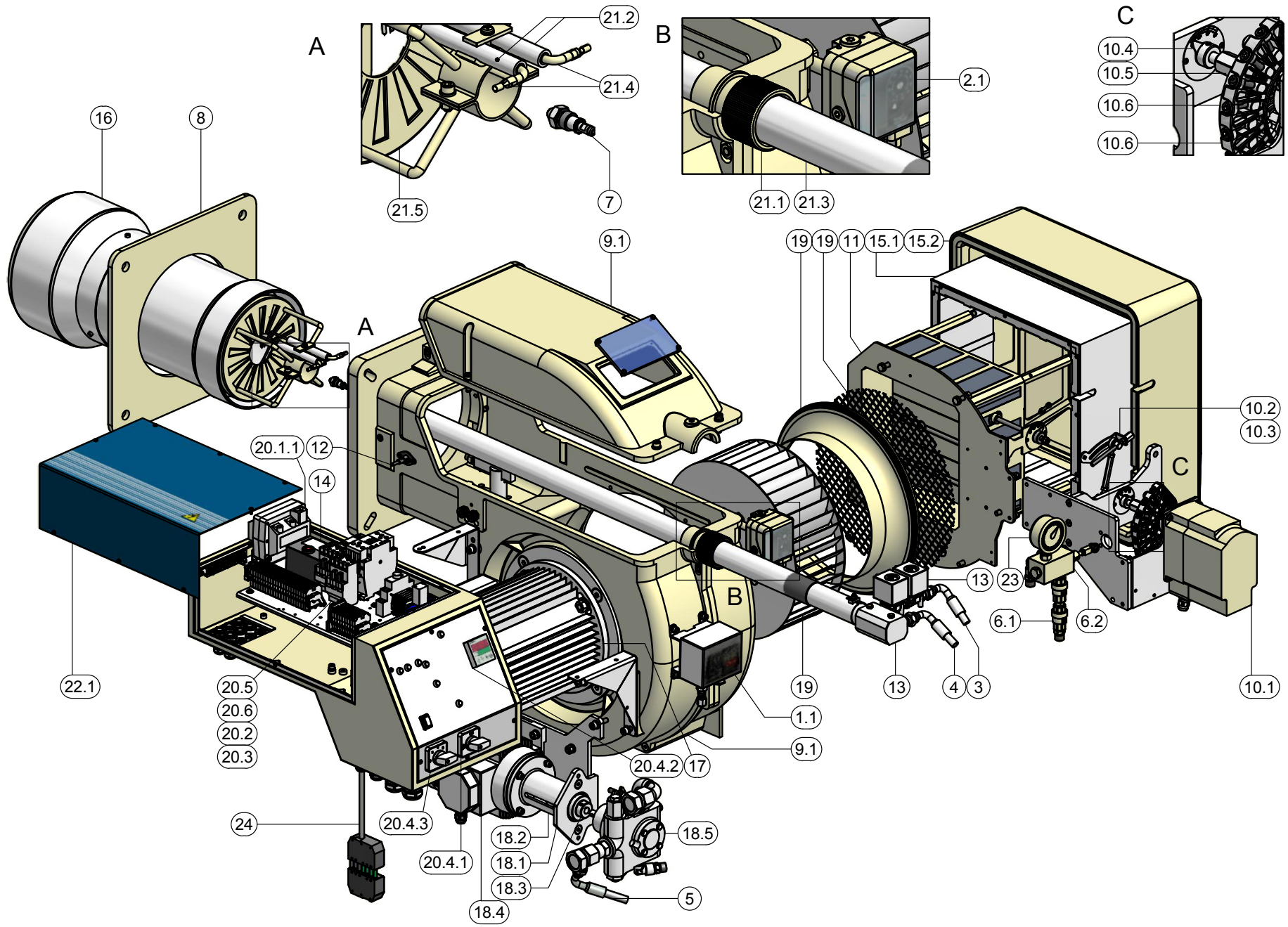

1.1	PRESSURE SWITCH	15.1	SILENCER	21.3	COMBUSTION HEAD ADJUSTING PIPE
2.1	AIR PRESSURE SWITCH	15.2	SILENCER	21.4	IGNITION CABLE
3	OIL FLEXIBLE HOSE	16	EXTENDED BLAST TUBE	21.5	COMBUSTION HEAD
4	OIL FLEXIBLE HOSE	17	MOTOR	22.1	COVER
5	OIL FLEXIBLE HOSE	18.1	BRACKET	23	PRESSURE GAUGE
6.1	ONE-WAY VALVE	18.2	BRACKET	24	MODULATOR CONNECTOR
6.2	PRESSURE GOVERNOR	18.3	COUPLING		
7	NOZZLE	18.4	MOTOR		
8	GENERATOR GASKET	18.5	PUMP		
9.1	BURNER HOUSING	19	FAN WHEEL		
10.1	ACTUATOR	20.1.1	IGNITION TRANSFORMER		
10.2	CAM	20.2	BIMETAL RELAY		
10.3	AIR ADJUSTING CAM REGULATING NUT	20.3	RELAY		
10.4	INDEX	20.4.1	SWITCH		
10.5	ADJUSTING CAM SHAFT	20.4.2	OUTPUT CONTROLLER		
10.6	ADJUSTING CAM	20.4.3	SWITCH		
11	AIR DAMPER	20.5	BIMETAL RELAY		
12	PHOTORESISTOR	20.6	CONTACTOR		
13	COMPLETE GUN	21.1	RING NUT		
14	CONTROL BOX	21.2	IGNITION ELECTRODE		

**SIEMENS OIL BURNERS AUTOMATIC CONTROLLER SIEMENS
LMO14 - LMO24 - LMO44**

The LMO... burner controls are designed for the start-up and supervision of single- or 2-stage forced draught oil burners in intermittent operation. Yellow-burning flames are supervised with photoresistive detectors QRB..., blue-burning flames with blue-flame detectors QRC...

In terms of housing dimensions, electrical connections and flame detectors, the LMO... are identical to the LOA... oil burner controls.

Preconditions for startup

- Burner control is reset
- All contacts in the line are closed
- No undervoltage
- Flame detector is darkened, no extraneous light

Undervoltage

- Safety shut-down in the operating position takes place should the mains voltage drop below about AC 165 V
- Restart is initiated when the mains voltage exceeds about AC 175 V

Time supervision oil pre-heater

If the oil pre-heater's release contact does not close within 10 minutes, the burner control will initiate lock-out.

Controlled intermittent operation

After no more than 24 hours of continuous operation, the burner control will initiate an automatic safety shut-down followed by a restart.

Control sequence in the event of fault

If lock-out occurs, the outputs for the fuel valves and the ignition will immediately be deactivated (< 1 second).

Cause	Response
After a mains failure	Restart
After voltage has fallen below the undervoltage threshold	Restart
In the event of a premature, faulty flame signal during «t1»	Lock-out at the end of «t1»
In the event of a premature, faulty flame signal during «tw»	Prevention of start-up, lock-out after no more than 40 seconds
If the burner does not ignite during «TSA»	Lock-out at the end of TSA
In the event the flame is lost during operation	Max. 3 repetitions, followed by lock-out
Oil pre-heater's release contact does not close within 10 min.	Lock-out

Lock-out

In the event of lock-out, the LMO... remains locked (lock-out cannot be changed), and the red signal lamp will light up. This status is also maintained in the case of a mains failure.

Resetting the burner

Whenever lock-out occurs, the burner control can immediately be reset. To do this, keep control the lock-out reset button depressed for about 1 second (< 3 seconds).

Ignition program with LMO24.113A2

If the flame is lost during «TSA», the burner will be reignited, but not later than at the end of «TSAmax.». This means that several ignition attempts can be made during TSA (refer to «Program sequence»).

Limitation of repetitions

If the flame is lost during operation, a maximum of 3 repetitions can be made. If the flame is lost for the 4th time during operation, the burner will initiate lock-out. The repetition count is restarted each time controlled switching on by «R-W-SB» takes place.

Operation

Lock-out reset button «EK...» is the key operating element for resetting the burner control and for activating / deactivating the diagnostic functions.



The multicolour «LED» is the key indicating element for both visual diagnosis and interface diagnosis.



- Red
- Yellow
- Green

Colour code table		
Status	Colour code	Colour
Oil pre-heater heats, waiting time «tw»	●●●●●●●●●●	Yellow
Ignition phase, ignition controlled	●○●○●○●○●○●○	Yellow-off
Operation, flame o.k.	□□□□□□□□□□	Green
Operation, flame not o.k.	□○□○□○□○□○□○	Green-off
Undervoltage	●●●●●●●●●●	Yellow-red
Fault, alarm	*****	Red
Output of fault code (refer to Fault code table)	●○●○●○●○●○	Red-off
Extraneous light prior to burner start-up	□●□●□●□●□●	Green-red
Interface diagnosis	*****	Red flicker light

Key

- Off
- Yellow
- Green
- Red

Diagnosis of cause of fault

After lock-out, the red fault signal lamp remains steady on.

In that condition, the visual diagnosis of the cause of fault according to the error code table can be activated by pressing the lock-out reset button for more than 3 seconds.

Error code table	
Blink code	Possible cause
2 blinks **	No establishment of flame at the end of TSA <ul style="list-style-type: none"> ● Faulty or soiled fuel valves ● Faulty or soiled flame detector ● Poor adjustment of burner, no fuel ● Faulty ignition
3 blinks ***	Free
4 blinks ****	Extraneous light on burner startup
5 blinks *****	Free
6 blinks *****	Free
7 blinks *****	Too many losses of flame during operation (limitation of the number of repetitions) <ul style="list-style-type: none"> ● Faulty or soiled fuel valves ● Faulty or soiled flame detector ● Poor adjustment of burner
8 blinks *****	Time supervision oil pre-heater
9 blinks *****	Free
10 blinks *****	Wiring error or internal error, output contacts

During the time the cause of fault is diagnosed, the control outputs are deactivated.

- Burner remains shut down
 - Fault status signal «AL» at terminal 10 is activated
- The diagnosis of the cause of fault is quit and the burner switched on again by resetting the burner control.

Press lock-out reset button for about 1 second (< 3 seconds).

Connection diagram and internal diagram

LMO14

LMO24 - LMO44

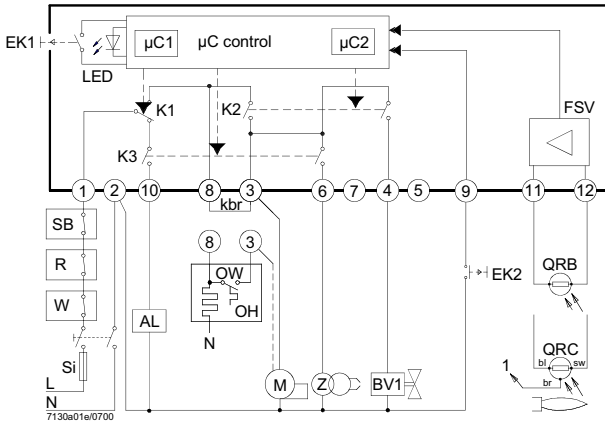

LMO24 - LMO44

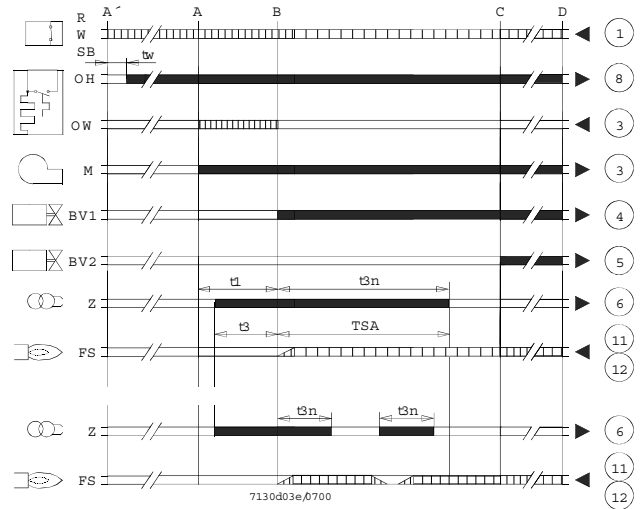

Key

- AL Alarm device
- kbr... Cable link (required only when no oil pre-heater is used)
- BV... Fuel valve
- EK1 Lock-out reset button
- EK2 Remote lock-out reset button
- FS Flame signal
- FSV Flame signal amplifier
- K... Contacts of control relay
- LED 3-colour signal lamps
- M Burner motor
- OW Release contact of oil pre-heater
- t1 Pre-purge time
- t3 Pre-ignition time
- t3n Post-ignition time
- A' Beginning of start-up sequence with burners using an oil pre-heater
- A Beginning of start-up sequence with burners using no oil pre-heater
- Controller output signals (represented by a white box)
- Required input signals (represented by a black box)
- OH Oil pre-heater
- QRB Photoresistive detector
- QRC Blue-flame detector
- bl = blue
- br = brown
- sw = black
- R Control thermostat or pressurestat
- SB Safety limit thermostat
- Si External primary fuse
- W Limit thermostat or pressure switch
- Z Ignition transformer
- t4 Interval from flame signal to release «BV2»
- TSA Ignition safety time
- tw Waiting time for oil pre-heating
- B Time of flame establishment
- C Operating position
- D Controlled shut-down by «R»
- µC1 Microcontroller 1
- µC2 Microcontroller 2

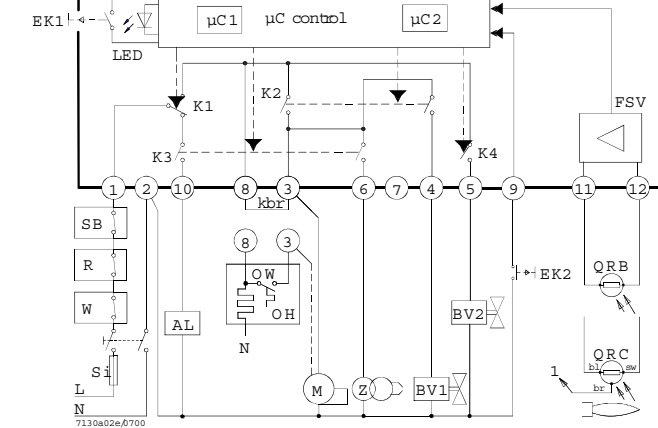

Control sequence

LMO14

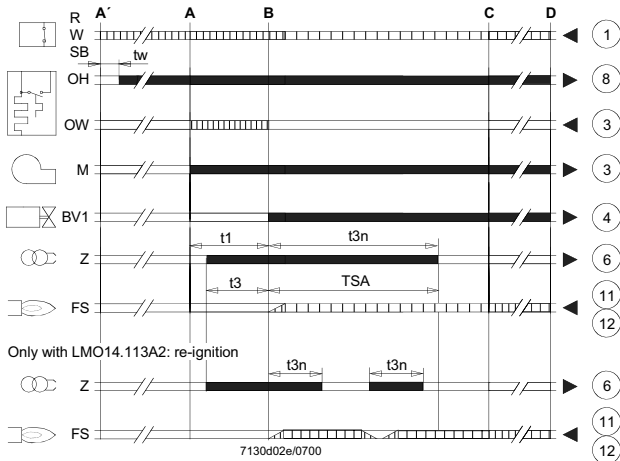

General unit data

Mains voltage	AC 230 V +10 % / -15 %		
	AC 120 V +10 % / -15 %		
Mains frequency	50...60 Hz ±6 %		
External primary fuse (Si)	6.3A (slow)		
Power consumption	12 VA		
Mounting orientation	optional		
Weight	approx. 200 g		
Degree of protection	IP40 (to be ensured through mounting)		
Perm. cable lengths	max. 3m at line capacitance of 100 pF/m		
Detector cable laid separately	10 m		
Remote reset laid separately	20m		

	LMO14	LMO24	LMO44
Terminal 1	5 A	5 A	5 A
Terminals 3 and 8	3 A	5 A	5 A
Terminals 4, 5 and 10	1 A	1 A	1A
Terminals 6	1 A	1 A	2A

Flame supervision with QRB and QRC

	QRB	QRC
Min. detector current required (with flame)	45 µA	70 µA
Min detector current permitted (without flame)	5.5 µA	5.5 µA
Max. possible with flame (typically)	100 µA	100 µA

Measurement circuit for detector current

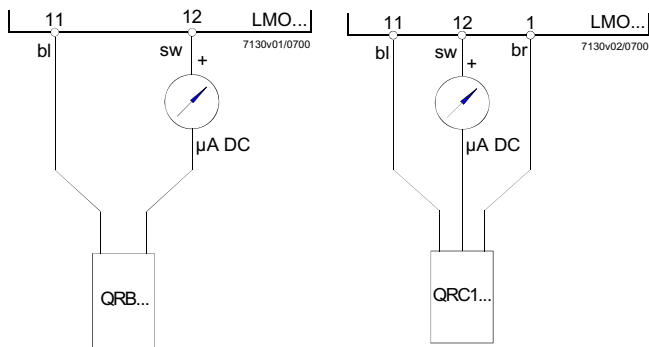

Key

µA DC	DC microamperometer with an internal resistance of 5 kΩ max.
bl	Blue
sw	Black
br	Brown

SIEMENS LAL.. CONTROL BOX

Use

- Control and supervision of oil atomization burners
- For burners of medium to high capacity
- For intermittent operation (at least one controlled shutdown every 24 hours)
- Universally applicable for multistage or modulating burners

Housing and plug-in base

- Made of impact-proof and heat-resistance black plastic
- Lockout reset button with viewing window; located behind it:
- Lockout warning lamp
- Lockout indicator coupled to the spindle of the sequence switch and visible in the transparent lockout reset button
- uses easy-to-remember symbols to indicate the type of fault and the point in time lockout occurred

Base and plug-in section of the LAL... are designed such that only burner controls of the LAL... family can be plugged in.

- 24 connection terminals
- Auxiliary terminals «31» and «32»
- 3 earth terminals terminating in a lug for earthing the burner
- 3 neutral conductor terminals prewired to terminal 2
- 14 knockout holes for cable entry by means of cable glands
- 8 at the side
- 6 in the bottom of the base
- 6 lateral threaded knockout holes for cable entry glands Pg11 or M20

Operation

Flame detector and flame simulation test are made automatically during burner off times and the prepurge time «t1». If loss of flame occurs during operation, the burner control will initiate lockout. If automatic repetition of the startup sequence is required, the clearly marked wire link on the plug-in section of the LAL... must be cut away.

Pre-conditions for burner startup

- Burner control is not in the lockout position
- Sequence switch is in its start position (with LAL2 voltage is present at terminals 11 and 12.
- Air damper is closed; end switch «z» for the CLOSED position must feed power from terminal 11 to terminal 8.
- Contact of the limit thermostat or pressure switch «W» and the contacts of any other switching devices in the control loop between terminals 4 and 5 must be closed e.g. a control contact for the oil preheater's temperature
- Normally closed contact of the air pressure switch must be closed.

Startup sequence

Start command by «R»:

- «R» closes the start control loop between terminals 4 and 5
- The sequence switch starts to run
- Only prepurging, fan motor at terminal 6 receives power
- Pre- and postpurging, fan motor or flue gas fan at terminal 7 receives power on completion of «t7»
- On completion of «t16», the control command for opening the air damper is delivered via terminal 9
- Terminal 8 receives no power during the positioning time
- The sequence switch continues to run only after the air damper has fully closed.

t1 Prepurge time with air damper fully open:

- The correct functioning of the flame supervision circuit is checked during «t1»
- The burner control will initiate lockout if correct functioning is not ensured.

With LAL2:

Shortly after the beginning of «t1», the air pressure switch must change over from terminal 13 to terminal 14 otherwise, the burner control will initiate lockout start of the air pressure check.

t3 Short preignition time:

«Z» must be connected to terminal 16, release of fuel via terminal 18.

t3' Long preignition time: «Z» connected to terminal 15.

t3n Postignition time:

- «Z» must be connected to terminal 15

- With short preignition, «Z» remains on until «TSA» has elapsed connection to terminal 16.

t4 Interval «BV1 – BV2» or «BV1 - LR»: On completion of «t4», voltage is present at terminal 19. The voltage is required to power «BV2» connected to auxiliary switch «v» in the actuator.

t5 Interval: On completion of «t5», terminal 20 receives power. At the same time, control outputs 9 to 11 and input 8 are galvanically separated from the LAL...’s control section.

LAL... is now protected against reverse voltages from the load control circuit. With the release of «LR» at terminal 20, the startup sequence of the LAL... ends. After a few idle steps (steps with no contact position changes), the sequence switch switches itself off.

B Operating position of the burner

B-C Burner operation: during burner operation, «LR» drives the air damper to the nominal load or low-fire position, depending on heat demand; the release of the nominal load takes place via auxiliary switch «v» in the actuator and in the event of loss of flame during operation, the LAL... will initiate lockout. For automatic start repetition, the clearly marked wire link «B» on the plugin section of the LAL... must be cut away.

C Controlled shutdown: in the case of controlled shutdown, «BV...» will immediately be closed. At the same time, the sequence switch is started to program «t6»

C-D Sequence switch travels to start position «A»

t6 Postpurge time: fan «M2» connected to terminal 7. Shortly after the start of «t6», terminal 10 receives power and the air damper is driven to the MIN position. Full closing of the air damper starts only shortly before «t6» has elapsed initiated by the control signal at terminal 11. During the following burner off time, terminal 11 is live.

t13 Permissible afterburn time: during «t13», the flame signal input may still receive a flame signal.

D-A End of control program: start position

As soon as the sequence switch has reached the start position – having thereby switched itself off – the flame detector and flame simulation test will start again.

During burner off times, the flame supervision circuit is live.

Lockout and indication of the stop position

Whenever a fault occurs, the sequence switch stops and with it the lockout indicator. The symbol appearing above the reading mark indicates the type of fault:

◀ No start. One of the contacts is not closed (also refer to «Preconditions for burner startup»):

Extraneous light:

Lockout during or after completion of the control program

Examples: nonextinguished flame, leaking fuel valves faulty flame supervision circuit.

▲ Interruption of startup. No OPEN signal at terminal 8 from the changeover end switch «a». Terminals 6, 7 and 15 are live until fault has been corrected

P Lockout. No air pressure indication at the beginning of the air pressure check. Air pressure failure after the air pressure check.

■ Defect in the flame supervision circuit.

▼ Interruption of the startup sequence. No positioning signal at terminal 8 from the auxiliary switch «m» for the low-fire position. Terminals 6, 7 and 15 are live until fault has been corrected.

1 Lockout. No flame signal at the end of the safety time.

| Flame signal has been lost during operation.

A Consenso all'avviamento (ad esempio tramite il termostato o il pressostato R dell'impianto

B Operating position of the burner

B-C Burner operation: during burner operation, «LR» drives the air damper to the nominal load or low-fire position, depending on heat demand; the release of the nominal load takes place via auxiliary switch «v» in the actuator and in the event of loss of flame during operation, the LAL... will initiate lockout. For automatic start repetition, the clearly marked wire link «B» on the plugin section of the LAL... must be cut away.

C Controlled shutdown: in the case of controlled shutdown, «BV...» will immediately be closed. At the same time, the sequence switch is started to program «t6»

C-D Sequence switch travels to start position «A».

During burner off times, the flame supervision circuit is live.

Lockout indication

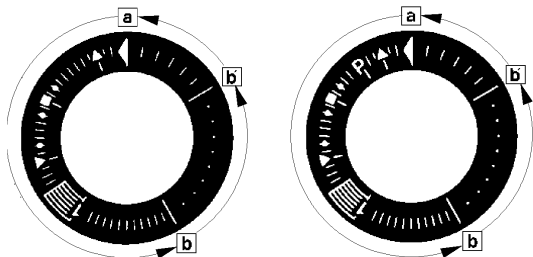

- a-b Startup sequence
- b-b' Idle step (with no contact confirmation)
- b(b')-a Postpurge program

Burner control can immediately be reset after lockout:
 Do not press the lockout reset button for more than 10 seconds
 The sequence switch always travels to the start position first
 After resetting
 After rectification of a fault that led to shutdown
 After each power failure
 During this period of time, power is only fed to terminals 7 and 9...11.
 Then, the LAL... will program a new burner startup sequence

Specifications

- Power supply AC 230 V -15 / +10 %
- for LAL2... on request AC 100 V -15 %...AC 110 V +10 %
- Frequency 50 Hz -6 %...60 Hz +6 %
- Absorption AC 3.5 VA
- Mounting position optional
- Protection IP 40
- Perm. input current at terminal 1 AC 5 A max., 20 A peak
- Perm. current rating of control terminals 3, 6, 7, 9...11, 15...20

Internal fuse
 External fuse
 Weight

4 A max., 20 A peak
 T6,3H250V according to IEC 127
 max. 10 A
 Device 1000 g
 Plug-in base 165 g

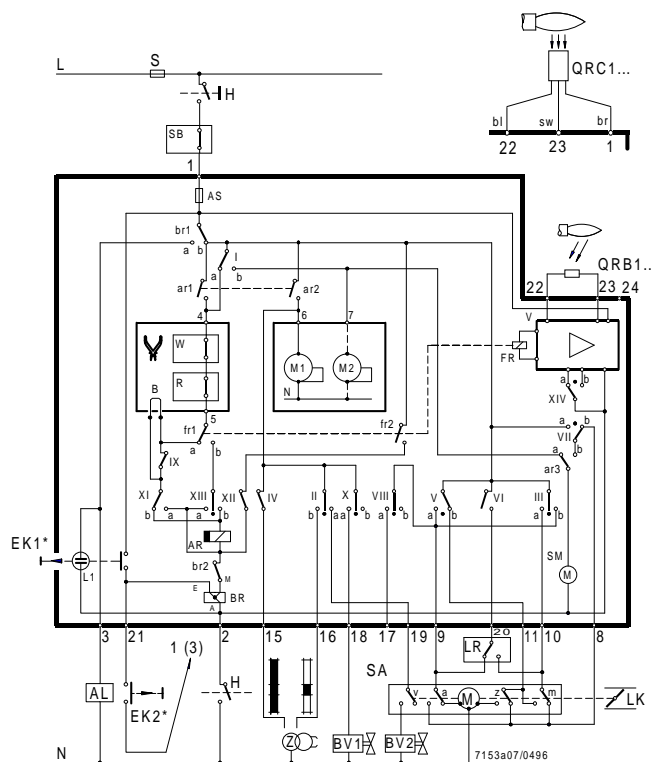

Sequence diagram

Control output at terminal

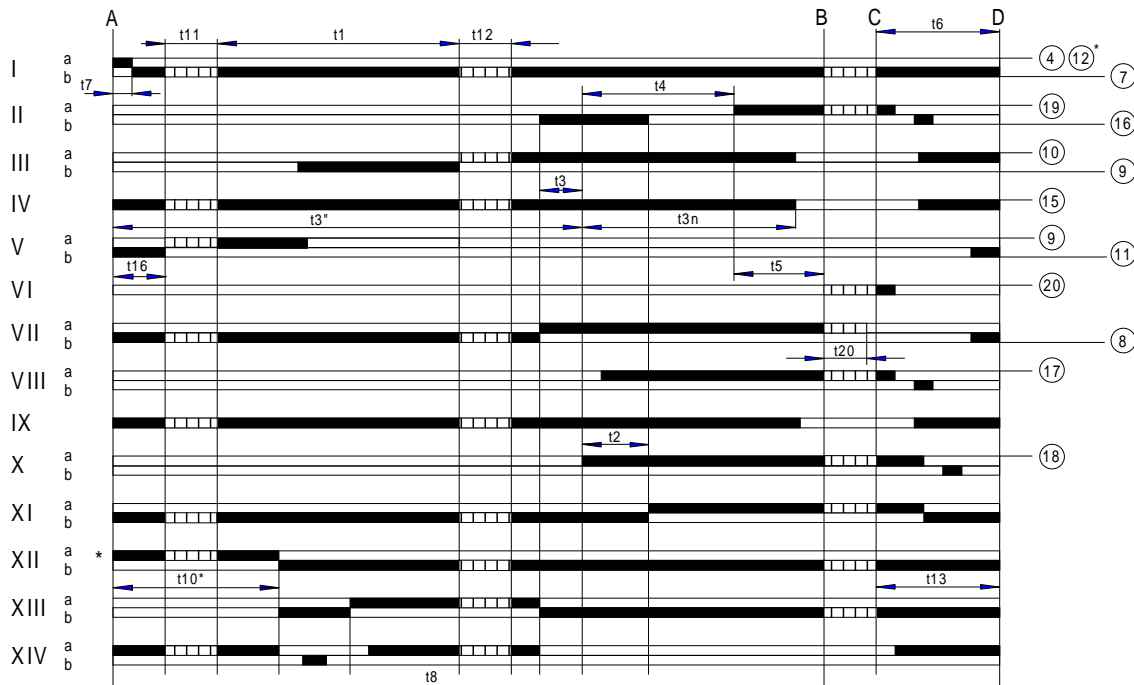

Lockout position indication

- Key**
- t1 Prepurge time with air damper fully open
 - t2 Safety time
 - t3 Preignition time, short («Z» connected to terminal 16)

- T3' Preignition time, long («Z» connected to terminal 15)
- t3n Postignition time («Z» connected to terminal 15)
- t4 Interval between voltage at terminals 18 and 19 («BV1-BV2»)
- t5 Interval between voltage at terminals 19 and 20 («BV2» load controller)



C.I.B. UNIGAS S.p.A.
Via L.Galvani, 9 - 35011 Campodarsego (PD) - ITALY
Tel. +39 049 9200944 - Fax +39 049 9200945
web site: www.cibunigas.it - e-mail: cibunigas@cibunigas.it

Note: specifications and data subject to change. Errors and omissions excepted.



USER'S MANUAL

COD. M12925CA Rel 1.2 08/2014

SOFTWARE VERSION 1.0x T73
code 80379 / Edition 01 - 06/2012



1 • INSTALLATION

• Dimensions and cut-out; panel mounting

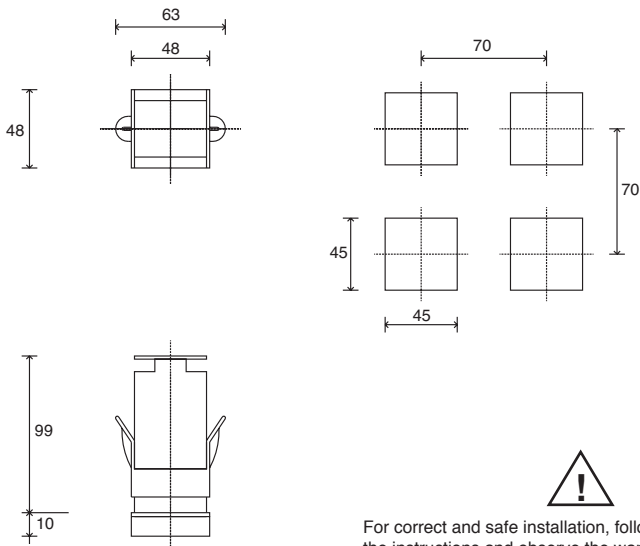

For correct and safe installation, follow the instructions and observe the warnings contained in this manual.

Panel mounting:

To fix the unit, insert the brackets provided into the seats on either side of the case. To mount two or more units side by side, respect the cut-out dimensions shown in the drawing.

CE MARKING: The instrument conforms to the European Directives 2004/108/CE and 2006/95/CE with reference to the generic standards: **EN 61000-6-2** (immunity in industrial environment) **EN 61000-6-3** (emission in residential environment) **EN 61010-1** (safety).

MAINTENANCE: Repairs must be done only by trained and specialized personnel.

Cut power to the device before accessing internal parts.

Do not clean the case with hydrocarbon-based solvents (Petrol, Trichlorethylene, etc.). Use of these solvents can reduce the mechanical reliability of the device. Use a cloth dampened in ethyl alcohol or water to clean the external plastic case.

SERVICE: GEFRA has a service department. The warranty excludes defects caused by any use not conforming to these instructions.

EMC conformity has been tested with the following connections

FUNCTION	CABLE TYPE	LENGTH
Power supply cable	1 mm ²	1 m
Relay output cable	1 mm ²	3,5 m
TC input	0,8 mm ² compensated	5 m
Pt100 input	1 mm ²	3 m

2 • TECHNICAL SPECIFICATIONS

Display	2x4 digit green, high display 10 and 7mm
Keys	4 of mechanical type (Man/Aut, INC, DEC, F)
Accuracy	0.2% f.s. ±1 digit ambient temperature 25°C
Main input (settable digital filter)	TC, RTD, PTC, NTC 60mV, 1V Ri≥1MΩ; 5V, 10V Ri≥10KΩ; 20mA Ri=50Ω Tempo di campionamento 120 msec.
Type TC Thermocouples (ITS90)	Type TC Thermocouples : J,K,R,S,T (IEC 584-1, CEI EN 60584-1, 60584-2) ; custom linearization is available / types B,E,N,L GOST,U,G,D,C are available by using the custom linearization.
Cold junction error	0,1° / °C
RTD type (scale configurable within indicated range, with or without decimal point) (ITS90) Max line resistance for RTD	DIN 43760 (Pt100), JPT100 20Ω
PTC type / NTC Type	990Ω, 25°C / 1KΩ, 25°C
Safety	detection of short-circuit or opening of probes, LBA alarm
°C / °F selection	configurable from faceplate
Linear scale ranges	-1999 to 9999 with configurable decimal point position
Controls	PID, Self-tuning, on-off
pb - dt - it	0,0...999,9 % - 0,00...99,99 min - 0,00...99,99 min
Action	Heat / Cool
Control outputs	on / off
Maximum power limit heat / cool	0,0...100,0 %
Cycle time	0...200 sec
Main output type	relay, logic, continuous (0...10V Rload ≥ 250KΩ, 0/4...20mA Rload ≤ 500Ω)
Softstart	0,0...500,0 min
Fault power setting	-100,0...100,0 %
Automatic blanking	Displays PV value, optional exclusion
Configurable alarms	Up to 3 alarm functions assignable to an output, configurable as: maximum, minimum, symmetrical, absolute/deviation, LBA
Alarm masking	- exclusion during warm up - latching reset from faceplate or external contact
Type of relay contact	NO (NC), 5A, 250V/30Vdc cosφ=1
Logic output for static relays	24V ±10% (10V min at 20mA)
Transmitter power supply	15/24Vdc, max 30mA short-circuit protection
Power supply (switching type)	(std) 100 ... 240Vac ±10% (opt.) 11...27Vac/dc ±10%; 50/60Hz, 8VA max
Faceplate protection	IP65
Working / Storage temperature range	0...50°C / -20...70°C
Relative humidity	20 ... 85% non-condensing
Environmental conditions of use	for internal use only, altitude up to 2000m
Installation	Panel, plug-in from front
Weight	160g for the complete version

3 · DESCRIPTION OF FACEPLATE

Function indicators
Indicates modes of operation

L1 MAN/AUTO = OFF (automatic control)
ON (manual control)

L2 PRE-HEATING = ON (running)

L3 SELFTUNING = ON (enabled Self)
OFF (disabled Self)

Automatic/Manual adjustment selection
Active only when PV display visualises the process variable (button pressed for at least 5 sec.)

"Inc" and "Dec" key
Press to increment (decrement) any numerical parameter •• Increment (decrement) speed is proportional to time key stays pressed •• The operation is not cyclic: once the maximum (minimum) value of a field is reached, the value will not change even if the key remains pressed.

Indication of output states
OUT 1 (AL1); OUT 2 (OPEN); OUT 3 (CLOSED)

PV Display: Indication of process variable
Error Indication: LO, HI, Sbr, Err
LO= the value of process variable is < di LO_S
HI= the value of process variable is > di HI_S
Sbr= faulty sensor or input values higher than max. limits
Err= PT100 third wire opened for PT100, PTC or input values lower than min. limits (i.e.: TC wrong connection)

SV display: Indication of setpoint

Function key
Gives access to the various configuration phases •• Confirms change of set parameters and browses next or previous parameter (if Auto/Man key is pressed)

4 · CONNECTIONS

• Outputs

Out2 (19) - 5A at 250Vac/30Vdc relay

Out1 (20) - 5A/250Vac relay

Out3 (6) - 5A at 250Vac/30Vdc relay

TOP

• Inputs

• TC Input

Available thermocouples:
J, K, R, S, T
(B, E, N, L, U, G, D, C custom linearization is available)

- Observe polarities
- For extensions, use the correct compensating cable for the type of TC used

• Power Supply

Standard:
100...240Vac ± 10%

Optional:
11...27Vac/Vdc ± 10%

Max. power 8VA; 50/60 Hz

• Linear input (I)

Linear input in dc current
20mA, Ri = 50Ω

• Input 1 linear with transmitter 2 wires

• Identification of boards

Power board - Solder side

Select transmitter voltage

N.B. : you can keep the **OUT1** relay energized at power-up by inserting jumper **S2** and removing resistance **R20**.

CPU board - Component side

IN/OUT boards (see appendix)

Select signal at contact 3

• Linear input (V)

Linear input in dc voltage
60mV, 1V
Ri > 1MΩ
5V, 10V
Ri > 10KΩ

• Pt100 / PTC / NTC

Use wires of adequate diameter (min. 1mm²)
PT100, JPT100, PTC, NTC

• Device structure

5 • “EASY” PROGRAMMING and CONFIGURATION

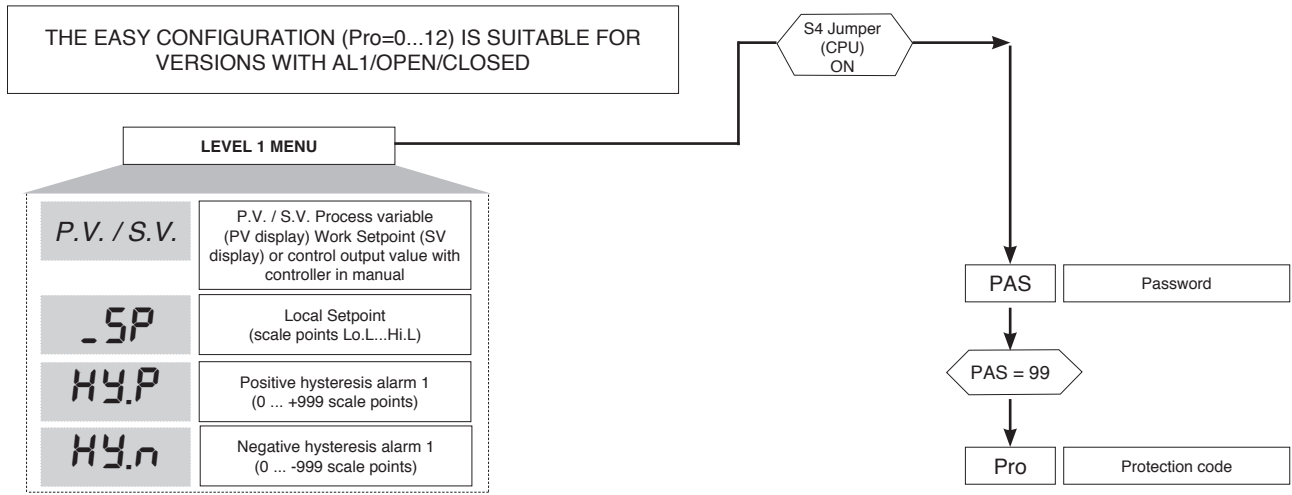

• Prot

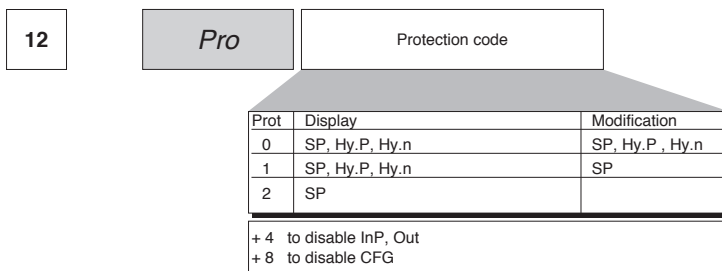

6 • PROGRAMMING and CONFIGURATION

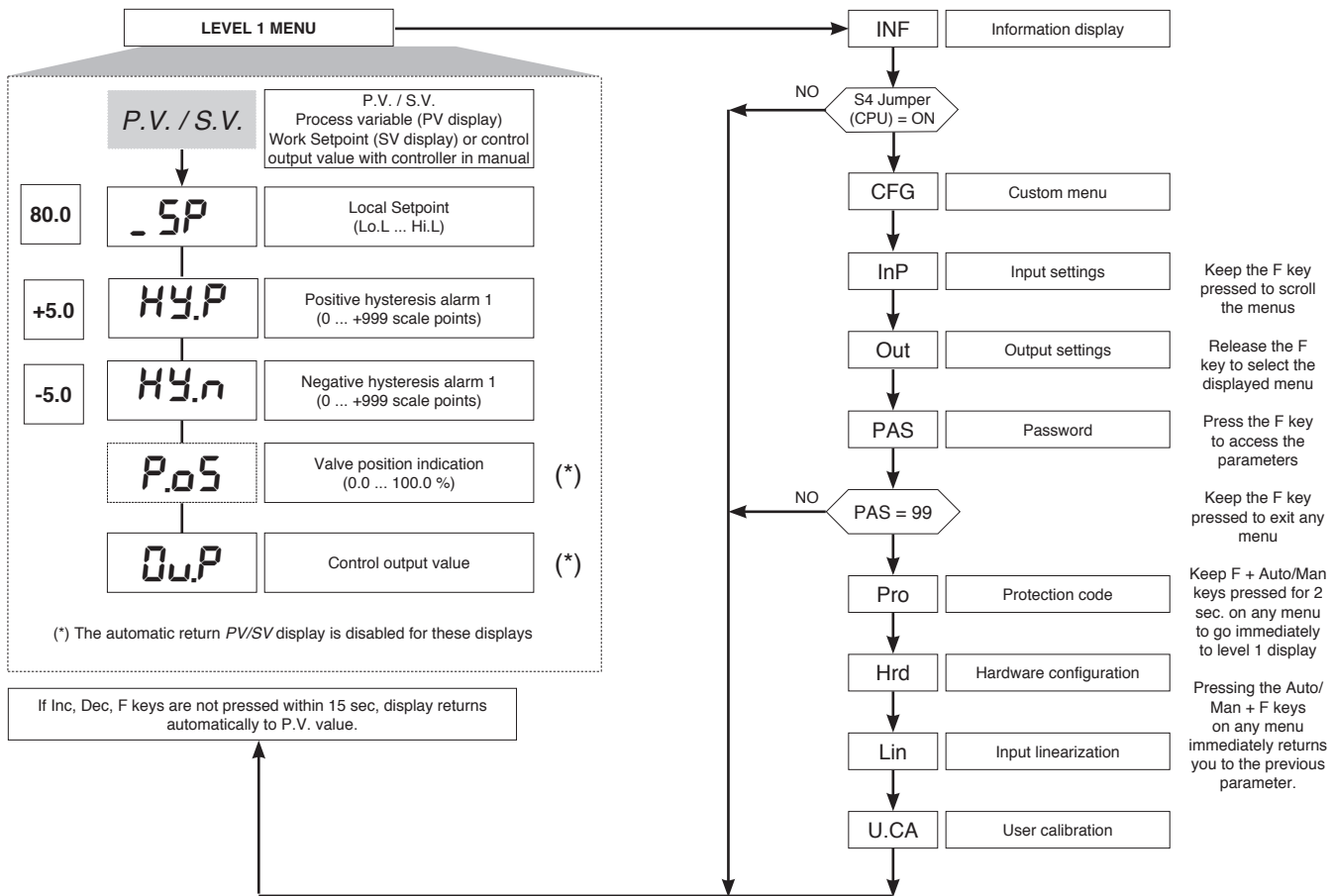

N.B.: Once a particular configuration is entered, all unnecessary parameters are no longer displayed

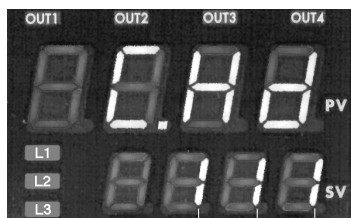

OUTPUT 2	OUTPUT 3	SERIAL COMMUNICATION
0 = None	0 = None	0 = None
1 = Relay	1 = Relay	

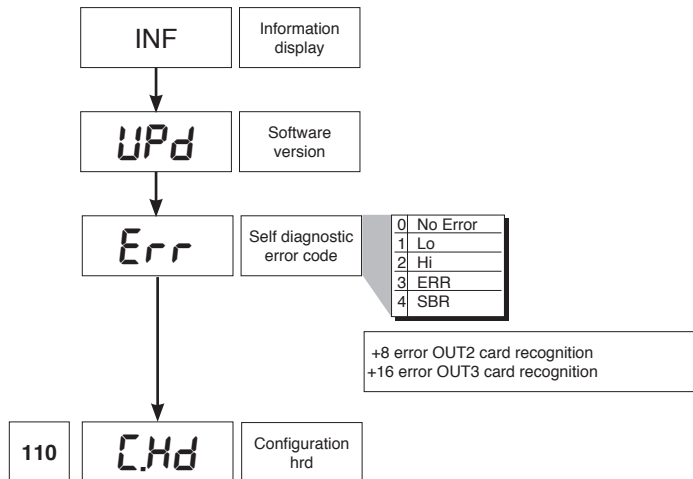

• CFG

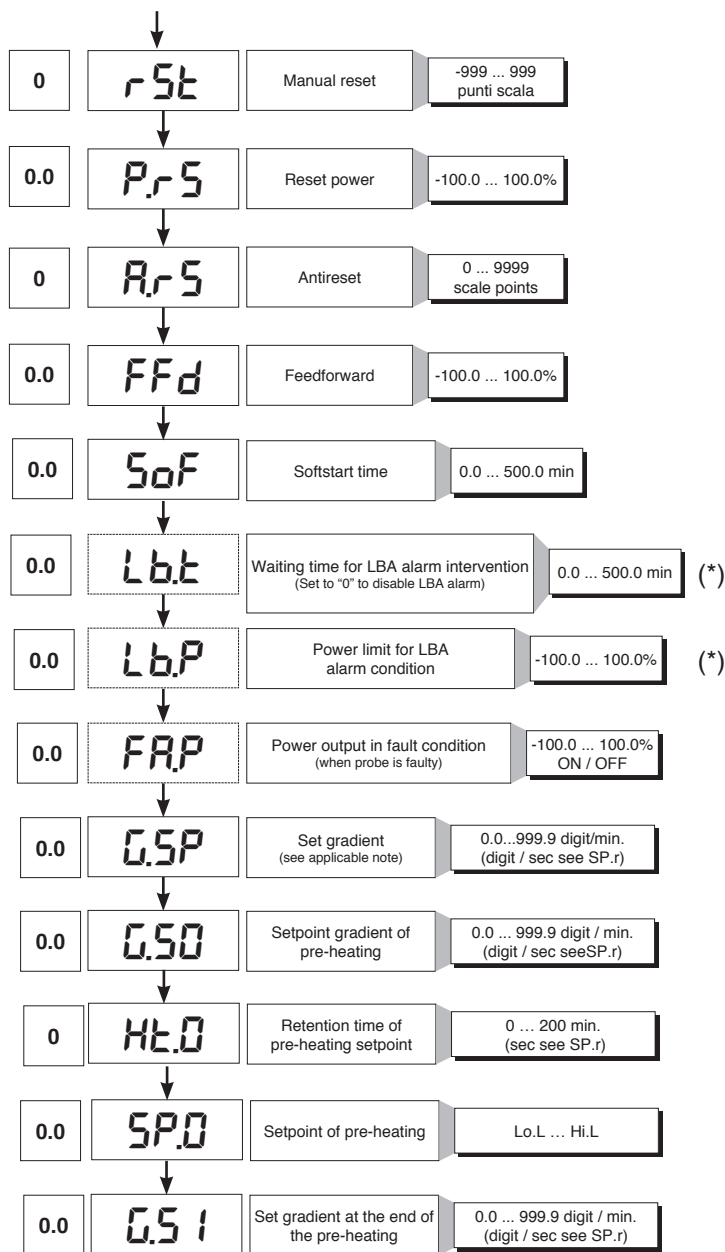
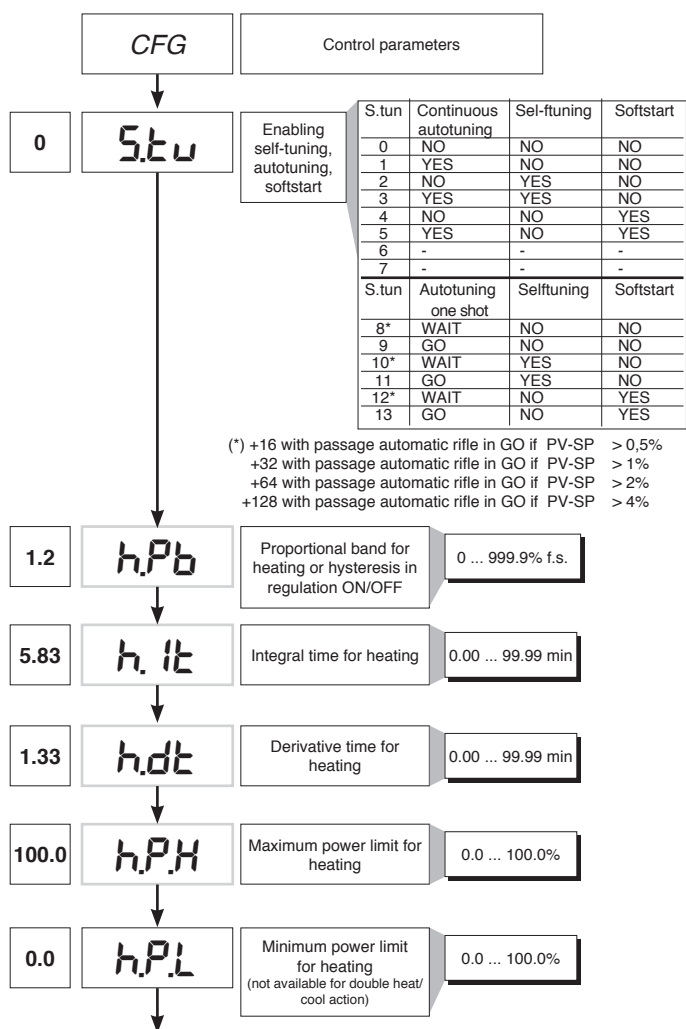

(*) LBA alarm may be reset by simultaneously pressing Δ + ▽ keys when OutP is displayed or by switching to Manual.

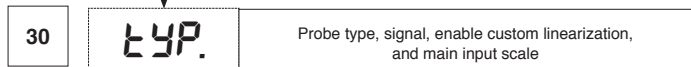
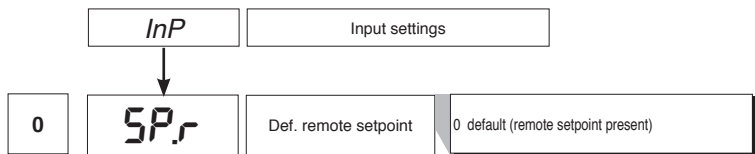

Type	Probe type	without decimal point	with decimal point
Sensore:			
TC			
0	TC J °C	0/1000	0.0/999.9
1	TC J °F	32/1832	32.0/999.9
2	TC K °C	0/1300	0.0/999.9
3	TC K °F	32/2372	32.0/999.9
4	TC R °C	0/1750	0.0/999.9
5	TC R °F	32/3182	32.0/999.9
6	TC S °C	0/1750	0.0/999.9
7	TC S °F	32/3182	32.0/999.9
8	TC T °C	-200/400	-199.9/400.0
9	TC T °F	-328/752	-199.9/752.0
28	TC	CUSTOM	CUSTOM
29	TC	CUSTOM	CUSTOM
30	PT100 °C	-200/850	-199.9/850.0
31	PT100 °F	-328/156.2	-199.9/999.9
32	JPT100 °C	-200/600	-199.9/600.0
33	JPT100 °F	-328/1112	-199.9/999.9
34	PTC °C	-55/120	-55.0/120.0
35	PTC °F	-67/248	-67.0/248.0
36	NTC °C	-10/70	-10.0/70.0
37	NTC °F	14/158	14.0/158.0
38	0...60 mV	-1999/9999	-199.9/999.9
39	0...60 mV	Custom scale	Custom scale
40	12...60 mV	-1999/9999	-199.9/999.9
41	12...60 mV	Custom scale	Custom scale
42	0...20 mA	-1999/9999	-199.9/999.9
43	0...20 mA	Custom scale	Custom scale
44	4...20 mA	-1999/9999	-199.9/999.9
45	4...20 mA	Custom scale	Custom scale
46	0...10 V	-1999/9999	-199.9/999.9
47	0...10 V	Custom scale	Custom scale
48	2...10 V	-1999/9999	-199.9/999.9
49	2...10 V	Custom scale	Custom scale
50	0...5 V	-1999/9999	-199.9/999.9
51	0...5 V	Custom scale	Custom scale
52	1...5 V	-1999/9999	-199.9/999.9
53	1...5 V	Custom scale	Custom scale
54	0...1 V	-1999/9999	-199.9/999.9
55	0...1 V	Custom scale	Custom scale
56	200mv...1V	-1999/9999	-199.9/999.9
57	200mv...1V	Custom scale	Custom scale
58	Cust10 V-20mA	-1999/9999	-199.9/999.9
59	Cust10 V-20mA	Custom scale	Custom scale
60	Cust 60mV	-1999/9999	-199.9/999.9
61	Cust 60mV	Custom scale	Custom scale
62	PT100-JPT	CUSTOM	CUSTOM
63	PTC	CUSTOM	CUSTOM
64	NTC	CUSTOM	CUSTOM

For custom linearization:
 - LO signal is generated with variable below Lo.S or at minimum calibration value
 - HI signal is generated with variable above Lo.S or at maximum calibration value

Max. non-linearity error for thermocouples (TC), resistors (PT100) and thermistors (PTC, NTC).
 The error is calculated as deviation from theoretical value and is expressed as percentage of full scale (in °C).

S, R range 0...1750°C; error < 0.2% f.s. (t > 300°C) / for other range; error < 0.5% f.s.
T error < 0.2% f.s. (t > -150°C)
B range 44...1800°C; error < 0.5% f.s. (t > 300°C) / range 44.0...999.9; error < 1% f.s. (t > 300°C)
U range -99.9...99.9 and -99...99°C; error < 0.5% f.s. / for other range; error < 0.2% f.s. (t > -150°C)
G error < 0.2% f.s. (t > 300°C)
D error < 0.2% f.s. (t > 200°C)
C range 0...2300; error < 0.2% f.s. / for other range; error < 0.5% f.s.

NTC error < 0.5% f.s.

Tc: J, K, E, N, L error < 0,2% f.s.
 JPT100 and PTC error < 0,2% f.s.
 PT100 scale -200...850°C
 Precision better than 0,2% f.s. at 25°C
 In range 0...50°C:
 • Precision better than 0,2% f.s. in range -200...400°C
 • Precision better than 0,4% f.s. in range +400...850°C (where f.s. refers to range -200... +850°C)

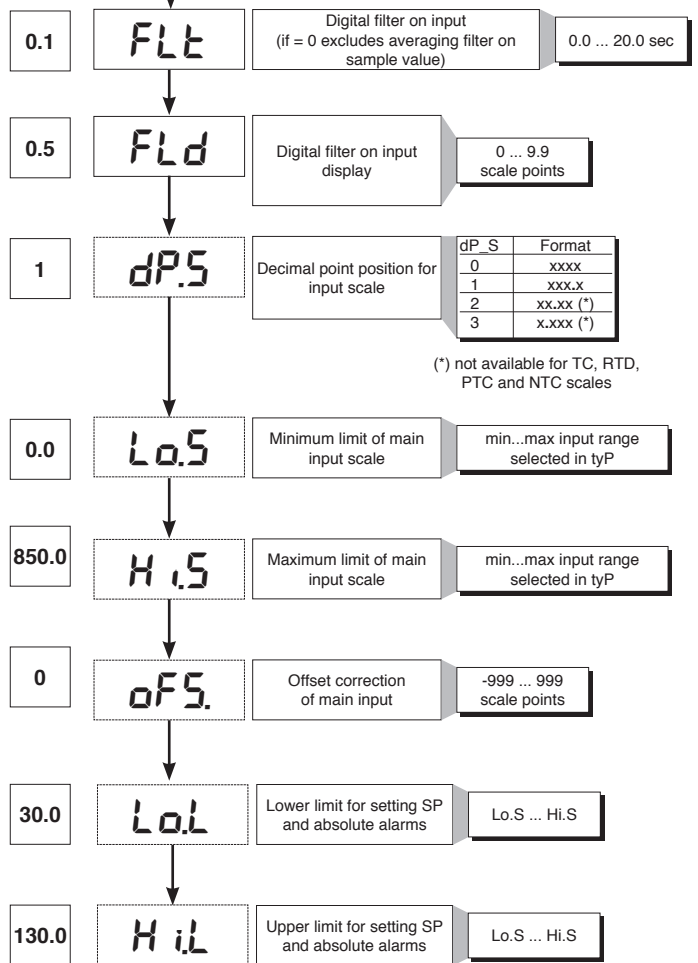

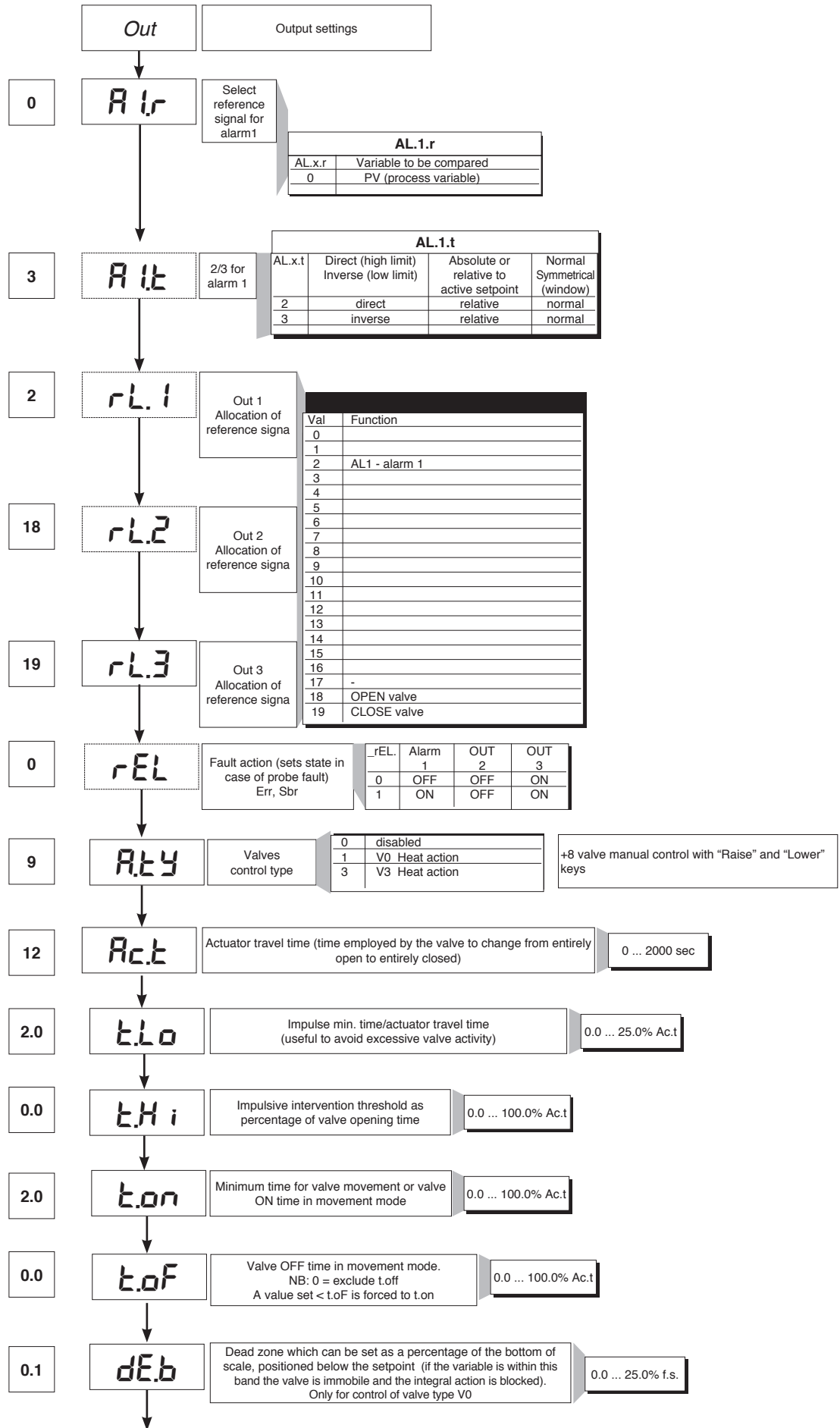

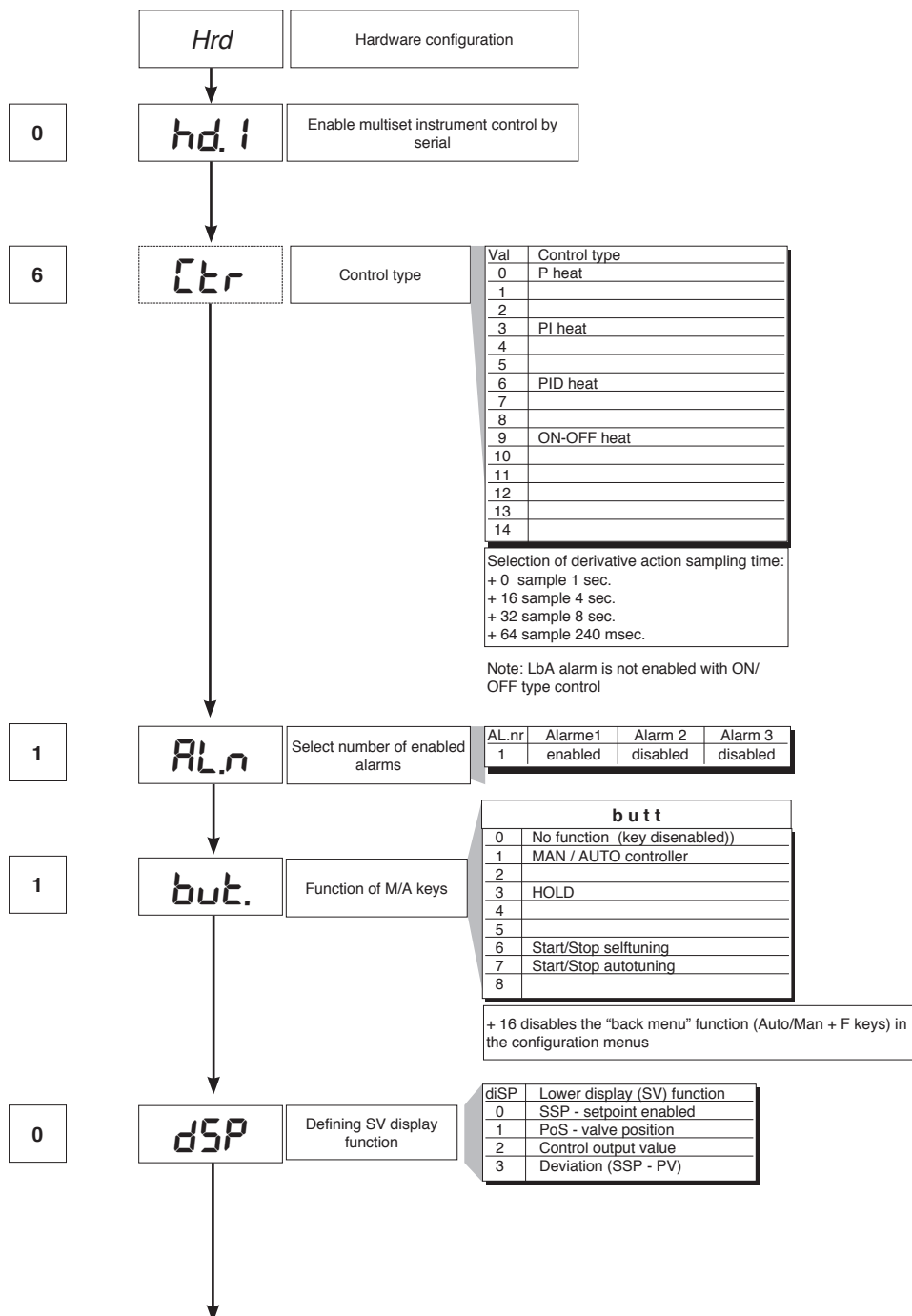
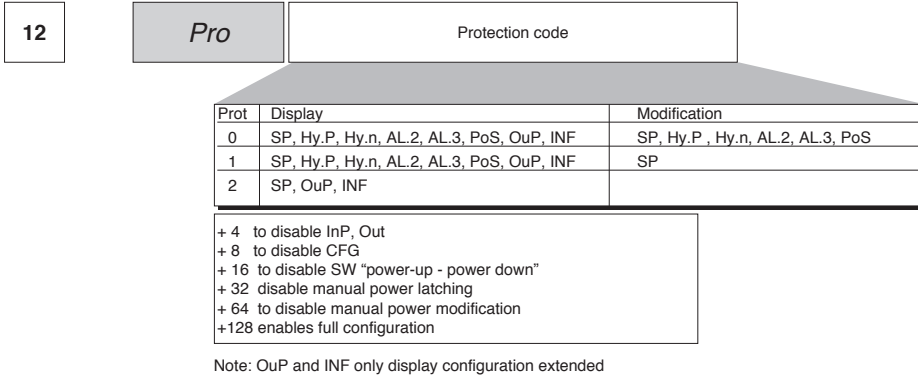

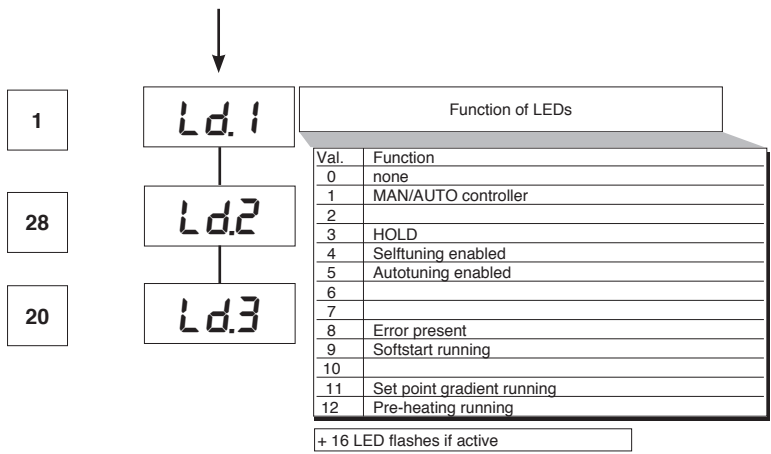

• Lin

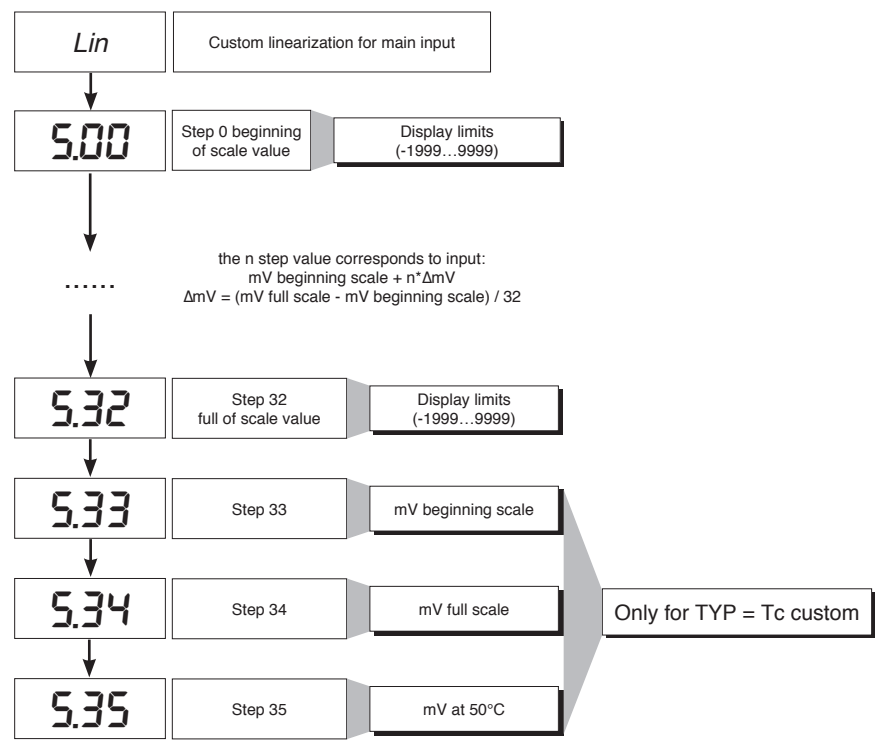

• U.CAL

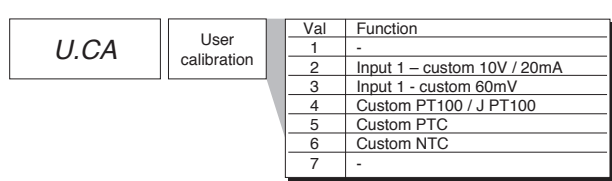

7 · CONSENT FOR BURNER AL1

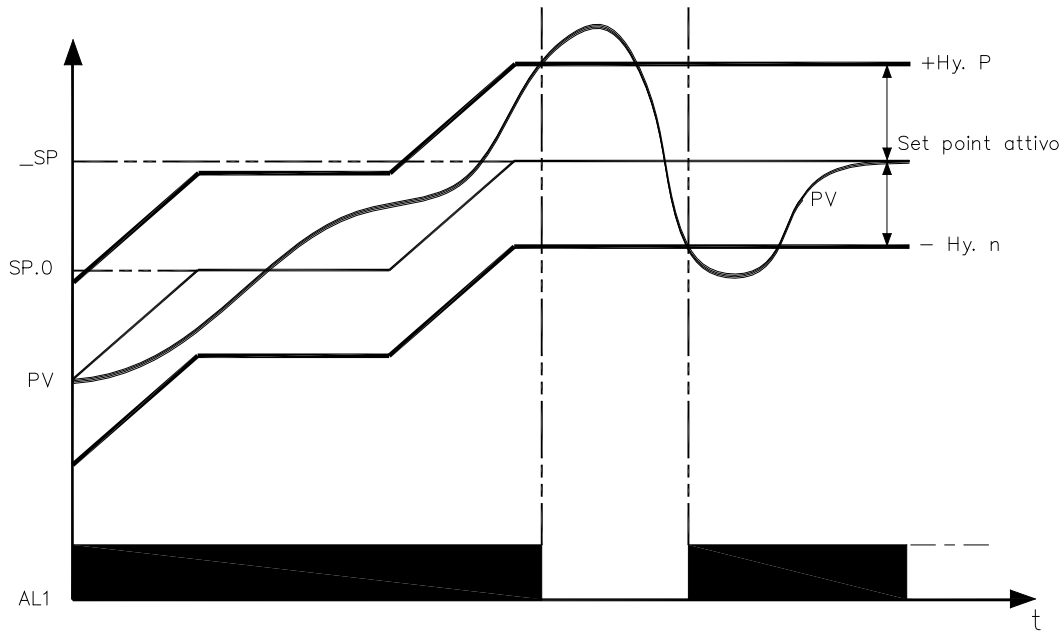

Obtain burner consent by configuring alarm 1 as inverse deviation with positive hysteresis Hy.P and negative hysteresis Hy.n

8 · PRE-HEATING FUNCTION

Enable the pre-heating function by setting parameters GS.0, Ht.0, GS.1 other than zero. It consists of three phases that are activated sequentially at firing:

- Ramp 0 phase

Enabled by setting $GS.0 > 0$. Starting from setpoint = PV (initial state), it reaches pre-heating set SP.0 with gradient GS.0

- Maintenance phase

Enabled by setting $Ht.0 > 0$. Maintains pre-heating setpoint SP.0 for time Ht.0

- Ramp 1 phase

Enabled by setting $GS.1 > 0$. Starting from pre-heating setpoint SP.0, it reaches active $_SP$ set with gradient GS.1

In case of selftuning, the pre-heating function is not activated

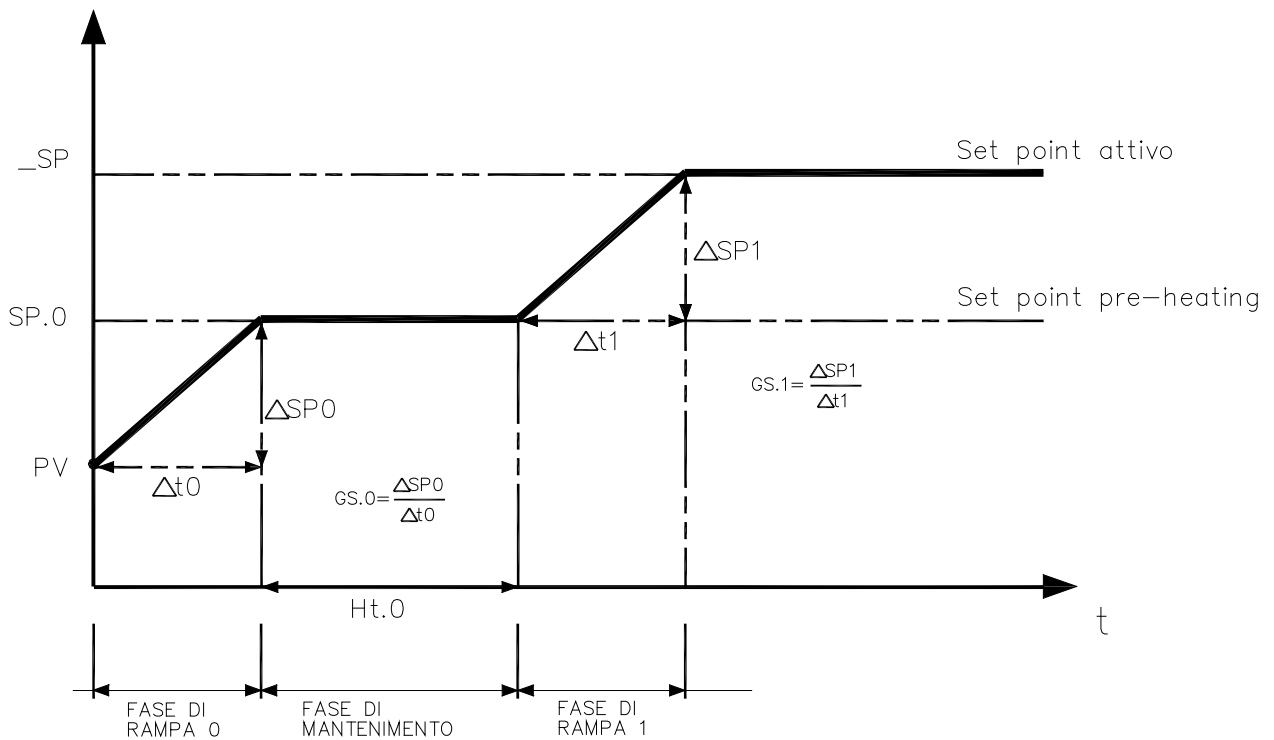

9 • ADJUSTMENT WITH MOTORIZED VALVE

In an adjustment process the adjustment valve has the function of varying fuel delivery (frequently corresponding to the thermal energy introduced into the process) in relation to the signal coming from the controller.

For this purpose it is provided with an actuator able to modify its opening value, overcoming the resistances produced by the fluid passing inside it.

The adjustment valves vary the delivery in a modulated manner, producing finite variations in the fluid passage inner area corresponding to finite variations of the actuator input signal, coming from the controller. The servomechanism, for example, comprises an electric motor, a reducer and a mechanical transmission system which actions the valve.

Various auxiliary components can be present such as the mechanical and electrical safety end travels, manual actioning systems.

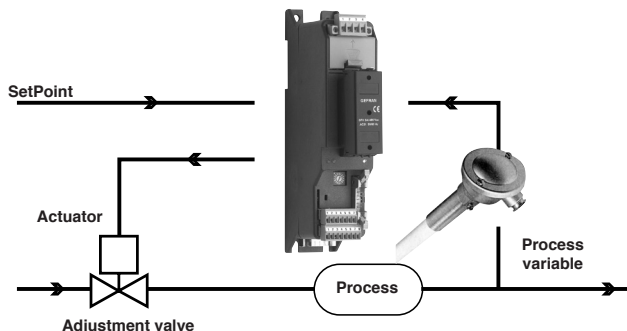

CONTROL EXAMPLE FOR V0 VALVE

The controller determines, on the basis of the dynamics of the process, the control output for the valve corresponding to the opening of the same in such a way so as to maintain the desired value of the process variable.

Characteristic parameters for valves control

- Actuator time ($A_c.t$) is the time employed by the valve to pass from entirely open to entirely closed (or vice-versa), and can be set with a resolution of one second. It is a mechanical feature of the valve+actuator unit.

NOTE: if the actuator's travel is mechanically limited it is necessary to proportionally reduce the $A_c.t$ value.

- Minimum impulse ($t.Lo$) expressed as a % of the actuator time (resolution 0.1%).

Represents the minimum change in position corresponding to a minimum change in power supplied by the instrument below which the actuator will not physically respond to the command.

This represents the minimum variation in position due to which the actuator does not physically respond to the command.

The minimum duration of the movement can be set in $t.Lo$, expressed as a % of actuator time.

- Impulsive intervention threshold ($t.Hi$) expressed as a % of the actuator time (resolution 0.1%) represents the position displacement (requested position – real position) due to which the manoeuvre request becomes impulsive.

You can choose between 2 types of control:

1) ON time of movement = $t.on$ and OFF time proportional to shift and greater than or equal to $t.Lo$ (we recommend setting $t.on = t.Lo$) (set $t.oF = 0$).

2) ON time of movement = $t.on$ and OFF time = $t.oF$. A value set for $t.oF < t.on$ is forced to $t.on$. To activate this type, set $t.oF >> 0$.

The type of movement approach allows fine control of the reverse drive valve (from potentiometer or not), especially useful in cases of high mechanical inertia. Set $t.Hi = 0$ to exclude modulation in positioning.

This type of modulated approach allows precise control of the feedback actioned valve, by a potentiometer or not, and is especially useful in cases of high mechanical inertia. Setting $t.Hi = 0$ excludes modulation in positioning.

- Dead zone ($dE.b$) is a displacement band between the adjustment setpoint and the process variable within which the controller does not supply any command to the valve (Open = OFF; Close = OFF). It is expressed as a percentage of the bottom scale and is positioned below the setpoint.

The dead zone is useful in an operative process to avoid straining the actuator with repeated commands and an insignificant effect on the adjustment. Setting $dE.b = 0$ the dead zone is excluded.

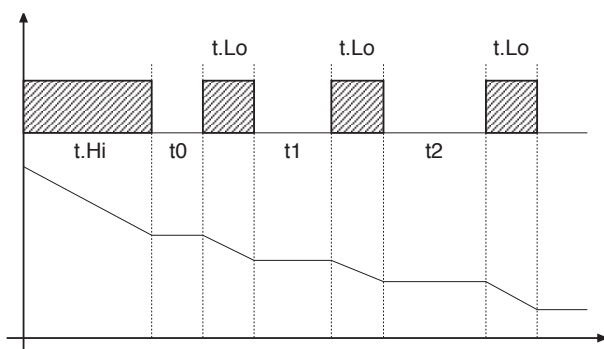

Graph of behavior inside the band with integral time $\neq 0$.

With integral time = 0, movement ON time is always equal to OFF time.

$t_0 = t.Lo$

Valve control modes

With the controller in manual, the setting of parameter At.y ≥ 8 allows direct control of the valve open and close commands through the keyboard Increments and Decrements on the front seats.

V0 - for floating valve without potentiometer

Model V0 have similar behaviour: every manoeuvre request greater than the minimum impulse t.Lo is sent to the actuator by means of the OPEN/CLOSE relays; every action updates the presumed position of the virtual potentiometer calculated on the basis of the actuator travel declared time.

In this way there is always a presumed position of the valve which is compared with the position request of the controller.

Having reached a presumed extreme position (entirely open or entirely closed determined by the "virtual potentiometer") the controller provides a command in the same direction, in this way ensuring the real extreme position is reached (minimum command time = t.on).

The actuators are usually protected against the OPEN command in the entirely open position or CLOSE command in the entirely closed position.

V3 - for floating valve, PI control

When the difference between the position calculated by the controller and the only proportional component exceeds the value corresponding to the minimum impulse t.Lo the controller provides an OPEN or CLOSE command of the duration of the minimum impulse itself t.Lo.

At each delivery the integral component of the command is set to zero (discharge of the integral).

The frequency and duration of the impulses is correlated to the integral time (h.it or c.it).

Non-movement behavior

t.Hi = 0: with power = 100% or 0.0%, the corresponding open or close outputs always remain enabled (safety status).

Movement behavior

t.Hi \neq 0: with position attained corresponding to 100% or 0.0%, the corresponding open or close outputs are switched off.

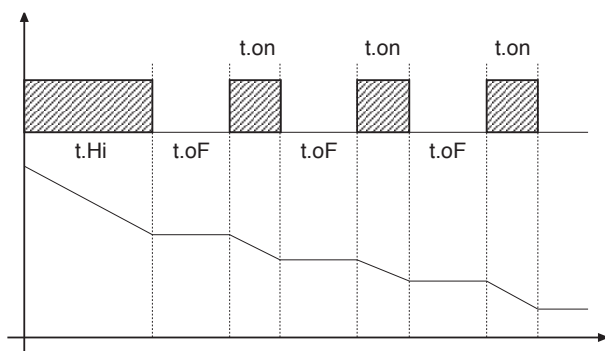

If t.oF = 0, current function is maintained.

If t.oF \neq 0 movement mode will be as shown on the graph

10 • CONTROL ACTIONS

Proportional Action:

action in which contribution to output is proportional to deviation at input (deviation = difference between controlled variable and setpoint).

Derivative Action:

action in which contribution to output is proportional to rate of variation input deviation.

Integral Action:

action in which contribution to output is proportional to integral of time of input deviation.

Influence of Proportional, Derivative and Integral actions on response of process under control

- * An increase in P.B. reduces oscillations but increases deviation.
- * A reduction in P.B. reduces the deviation but provokes oscillations of the controlled variable (the system tends to be unstable if P.B. value is too low).
- * An increase in Derivative Action corresponds to an increase in Derivative Time, reduces deviation and prevents oscillation up to a critical value of Derivative Time, beyond which deviation increases and prolonged oscillations occur.
- * An increase in Integral Action corresponds to a reduction in Integral Time, and tends to eliminate deviation between the controlled variable and the setpoint when the system is running at rated speed.

If the Integral Time value is too long (Weak integral action), deviation between the controlled variable and the setpoint may persist.

Contact GEFRA for more information on control actions.

11 • MANUAL TUNING

- A) Enter the setpoint at its working value.
- B) Set the proportional band at 0.1% (with on-off type setting).
- C) Switch to automatic and observe the behavior of the variable. It will be similar to that in the figure:

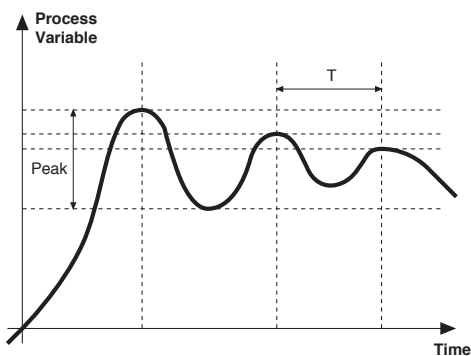

D) The PID parameters are calculated as follows: Proportional band

$$P.B. = \frac{\text{Peak}}{(V \text{ max} - V \text{ min})} \times 100$$

(V max - V min) is the scale range.

Integral time: $I_t = 1.5 \times T$

Derivative time: $d_t = I_t/4$

E) Switch the unit to manual, set the calculated parameters. Return to PID action by setting the appropriate relay output cycle time, and switch back to Automatic.

F) If possible, to optimize parameters, change the setpoint and check temporary response. If an oscillation persists, increase the proportional band. If the response is too slow, reduce it.

12 • SET GRADIENT

SET GRADIENT: if set to $\neq 0$, the setpoint is assumed equal to PV at power-on and auto/man switchover. With gradient set, it reaches the local setpoint. Every variation in setpoint is subject to a gradient.

The set gradient is inhibited at power-on when self-tuning is engaged.

If the set gradient is set to $\neq 0$, it is active even with variations of the local setpoint.

The control setpoint reaches the set value at the speed defined by the gradient.

13 • SOFTWARE ON / OFF SWITCHING FUNCTION

How to switch the unit OFF: hold down the “F” and “Raise” keys simultaneously for 5 seconds to deactivate the unit, which will go to the OFF state while keeping the line supply connected and keeping the process value displayed. The SV display is OFF.

All outputs (alarms and controls) are OFF (logic level 0, relays de-energized) and all unit functions are disabled except the switch-on function and digital communication.

How to switch the unit ON: hold down the “F” key for 5 seconds and the unit will switch OFF to ON. If there is a power failure during the OFF state, the unit will remain in OFF state at the next power-up (ON/OFF state is memorized).

The function is normally enabled, but can be disabled by setting the parameter Prot = Prot +16.

14 • SELF-TUNING

The function works for single output systems (heating or cooling). The self-tuning action calculates optimum control parameter values during process startup. The variable (for example, temperature) must be that assumed at zero power (room temperature).

The controller supplies maximum power until an intermediate value between starting value and setpoint is reached, after which it zeros power.

PID parameters are calculated by measuring overshoot and the time needed to reach peak. When calculations are finished, the system disables automatically and the control proceeds until the setpoint is reached.

How to activate self-tuning:

A. Activation at power-on

1. Set the setpoint to the required value
2. Enable selftuning by setting the Stun parameter to 2 (CFG menu)
3. Turn off the instrument
4. Make sure the temperature is near room temperature
5. Turn on the instrument again

B. Activation from keyboard

1. Make sure that key M/A is enabled for Start/Stop selftuning (code but = 6 Hrd menu)
2. Bring the temperature near room temperature
3. Set the setpoint to the required value
4. Press key M/A to activate selftuning (Attention: selftuning interrupts if the key is pressed again)

The procedure runs automatically until finished, when the new PID parameters are stored: proportional band, integral and derivative times calculated for the active action (heating or cooling). In case of double action (heating or cooling), parameters for the opposite action are calculated by maintaining the initial ratio between parameters (ex.: $CPb = HPb \times K$; where $K = CPb / HPb$ when self-tuning starts). When finished, the Stun code is automatically cancelled.

Notes :

-The procedure does not start if the temperature is higher than the setpoint (heating control mode) or if the temperature is lower than the setpoint (cooling control mode). In this case, the Stun code is not cancelled.

-It is advisable to enable one of the configurable LEDs to signal selftuning status. By setting one of parameters LED1, LED2, LED3=4 or 20 on the Hrd menu, the respective LED will be on or flashing when selftuning is active.

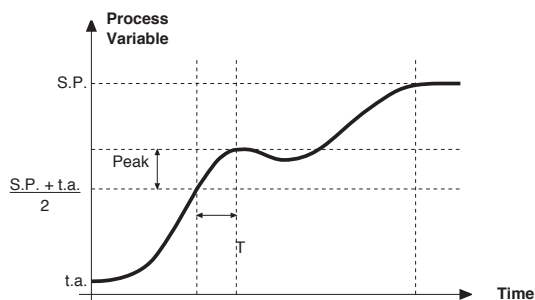

15 • ACCESSORIES

• Interface for instrument configuration



Kit for PC via the USB port (Windows environment) for GEFTRAN instruments configuration:

Lets you read or write all of the parameters

- A single software for all models
- Easy and rapid configuration
- Saving and management of parameter recipes
- On-line trend and saving of historical data

Component Kit:

- Connection cable PC USB ... port TTL
- Connection cable PC USB ... RS485 port
- Serial line converter
- CD SW GF Express installation

• ORDERING CODE

GF_eXK-2-0-0	cod F049095
--------------	-------------

16 • ORDER CODE

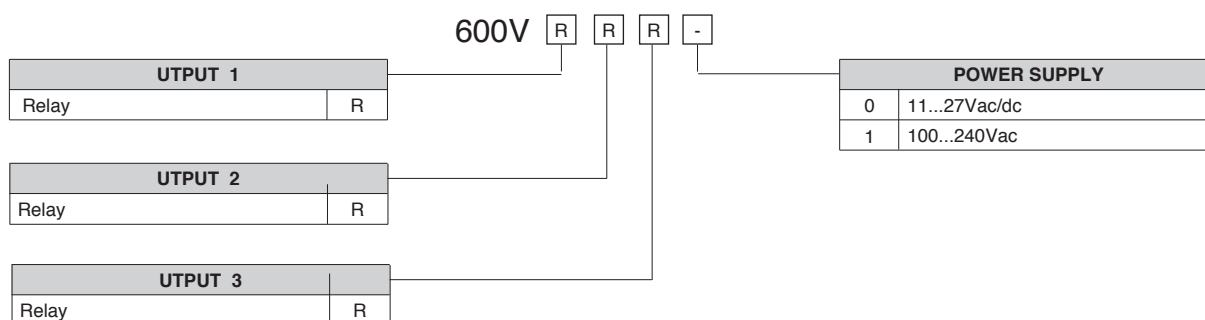

• WARNINGS

WARNING: this symbol indicates danger. It is placed near the power supply circuit and near high-voltage relay contacts.

Read the following warnings before installing, connecting or using the device:

- follow instructions precisely when connecting the device.
- always use cables that are suitable for the voltage and current levels indicated in the technical specifications.
- the device has no ON/OFF switch: it switches on immediately when power is turned on. For safety reasons, devices permanently connected to the power supply require a two-phase disconnecting switch with proper marking. Such switch must be located near the device and must be easily reachable by the user. A single switch can control several units.
- if the device is connected to electrically NON-ISOLATED equipment (e.g. thermocouples), a grounding wire must be applied to assure that this connection is not made directly through the machine structure.
- if the device is used in applications where there is risk of injury to persons and/or damage to machines or materials, it MUST be used with auxiliary alarm units. You should be able to check the correct operation of such units during normal operation of the device.
- before using the device, the user must check that all device parameters are correctly set in order to avoid injury to persons and/or damage to property.
- the device must NOT be used in inflammable or explosive environments. It may be connected to units operating in such environments only by means of suitable interfaces in conformity to local safety regulations.
- the device contains components that are sensitive to static electrical discharges. Therefore, take appropriate precautions when handling electronic circuit boards in order to prevent permanent damage to these components.

Installation: installation category II, pollution level 2, double isolation

The equipment is intended for permanent indoor installations within their own enclosure or panel mounted enclosing the rear housing and exposed terminals on the back.

- only for low power supply: supply from Class 2 or low voltage limited energy source
- power supply lines must be separated from device input and output lines; always check that the supply voltage matches the voltage indicated on the device label.
- install the instrumentation separately from the relays and power switching devices
- do not install high-power remote switches, contactors, relays, thyristor power units (particularly if "phase angle" type), motors, etc... in the same cabinet.
- avoid dust, humidity, corrosive gases and heat sources.
- do not close the ventilation holes; working temperature must be in the range of 0...50°C.

- surrounding air: 50°C
- use 60/75°C copper (Cu) conductor only, wire size range 2x No 22 - 14AWG, Solid/Stranded
- use terminal tightening torque 0.5N m

If the device has faston terminals, they must be protected and isolated; if the device has screw terminals, wires should be attached at least in pairs.

• **Power:** supplied from a disconnecting switch with fuse for the device section; path of wires from switch to devices should be as straight as possible; the same supply should not be used to power relays, contactors, solenoid valves, etc.; if the voltage waveform is strongly distorted by thyristor switching units or by electric motors, it is recommended that an isolation transformer be used only for the devices, connecting the screen to ground; it is important for the electrical system to have a good ground connection; voltage between neutral and ground must not exceed 1V and resistance must be less than 60hm; if the supply voltage is highly variable, use a voltage stabilizer for the device; use line filters in the vicinity of high frequency generators or arc welders; power supply lines must be separated from device input and output lines; always check that the supply voltage matches the voltage indicated on the device label.

• **Input and output connections:** external connected circuits must have double insulation; to connect analog inputs (TC, RTD) you have to: physically separate input wiring from power supply wiring, from output wiring, and from power connections; use twisted and screened cables, with screen connected to ground at only one point; to connect adjustment and alarm outputs (contactors, solenoid valves, motors, fans, etc.), install RC groups (resistor and capacitor in series) in parallel with inductive loads that work in AC (*Note: all capacitors must conform to VDE standards (class x2) and support at least 220 VAC. Resistors must be at least 2W*); fit a 1N4007 diode in parallel with the coil of inductive loads that operate in DC.

GEFRAN spa will not be held liable for any injury to persons and/or damage to property deriving from tampering, from any incorrect or erroneous use, or from any use not conforming to the device specifications.

Set-up for 600V RRR0-1-T73 regulator

Set up for temperature probe Pt100 (ex Siemens QAE2120 130°C max.)

The regulator comes out of the factory preset with the corresponding values of the Siemens RWF40.000 and RWF50.2x

Verify wiring of the sensor

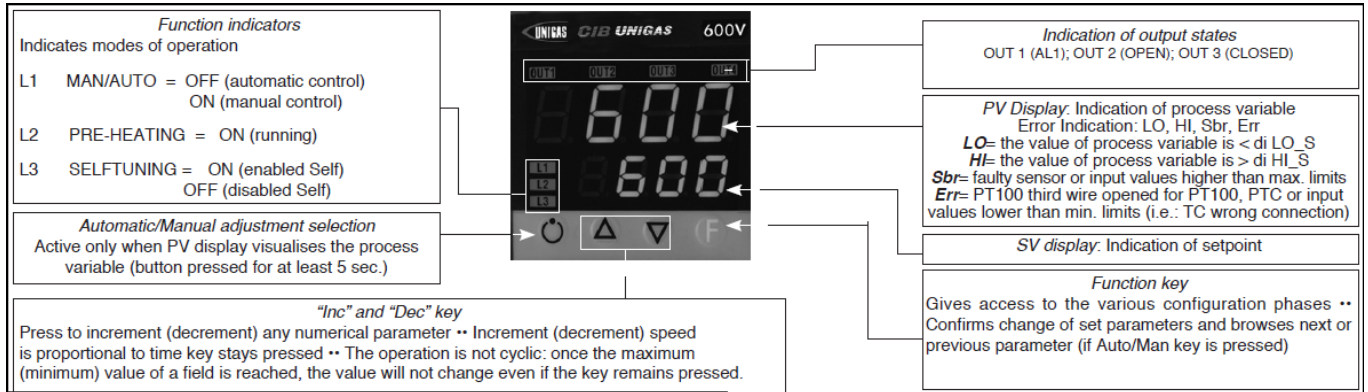

Regulation of the set-point = 80

It can be modified by using arrows "up" and "down".

By pushing F you go to parameters:

Hy.P	5 (hysteresis positive for output 1, terminals 21-22 (ex Q13-Q14))
Hy.n	-5 hysteresis negative for output ,1 terminals 21-22 (ex Q13-Q14)

Keep pushing F until you see **PASS**, release F and through the arrows set **99**, push F and visualize **Pro** (protection code) default is **12**, through the arrows set **128** and push F, keep it pushed until all parameters **InF**, **CFG**, **InP**, **Out**, **PASS** are visualized.

CFG	
S.tun	0
hPb	1,2
hIt	5,83
hdt	1,33
...	

InP	
....	
tyP	30 (Pt100)
...	
dP_S	1 (decimals num.)
Lo.S	0 (min. sensor scale)
Hi.S	850,0 (max sensor scale)
oFS	0 (offset of input correction)
Lo.L	30,0 (lower set-point range limit)
Hi.L	130,0 (upper set-point range limit)

Out	
A1.r	0
...	
A1.t	3 (operating mode AL1 =inverse-relative-normal)
...	
rL.1	2 (AL1)
rL.2	18 (open)
rL.3	19 (close)
rEL	0
A.ty	9 (type of servocontrol command)
Ac.t	12 (servocontrol running time: SQN72.4.../STA12..=12; SQM40.265=30)
t Lo	2
t Hi	0.0
t.on	2
t.oF	0.0
dE.b	0,1 (dead zone in % of end scale)

PAS	99 then push and keep pushed F until visualization of Hrd
Hrd	
...	
Ctrl	6 (PID warm)
AL.nr	1
but	1
diSP	0
Ld.1	1
Ld.2	28
Ld.3	20

Keep pushed **F** until you visualize **PASS**, release **F** and through the arrows set **99**, push **F** and visualize **Pro** (protection code) from **128**, through the arrows, bring it back to **12**, and keep **F** pushed until you come back to set-point value.

Manual operation :

Keep pushed the lower left key for at least 5 sec.

The instrument will enter the "MAN" mode (see also "Ld1" switching on).

Through the arrows, "Open" and "Close" outputs are activated.

To come back to normal working keep the lower left key pushed for at least 5 sec.

Software switch off :

By keeping pushed keys **Arrow up** + **F** for more than 5 sec. the instrument switches off the software, does not command the outputs and visualize only the variable of process measured by the probe.

To restore keep pushed **F** for more than 5 sec.

Set up for temperature probe Pt100 for high temperature (350°C max.)

Verify wiring of the sensor

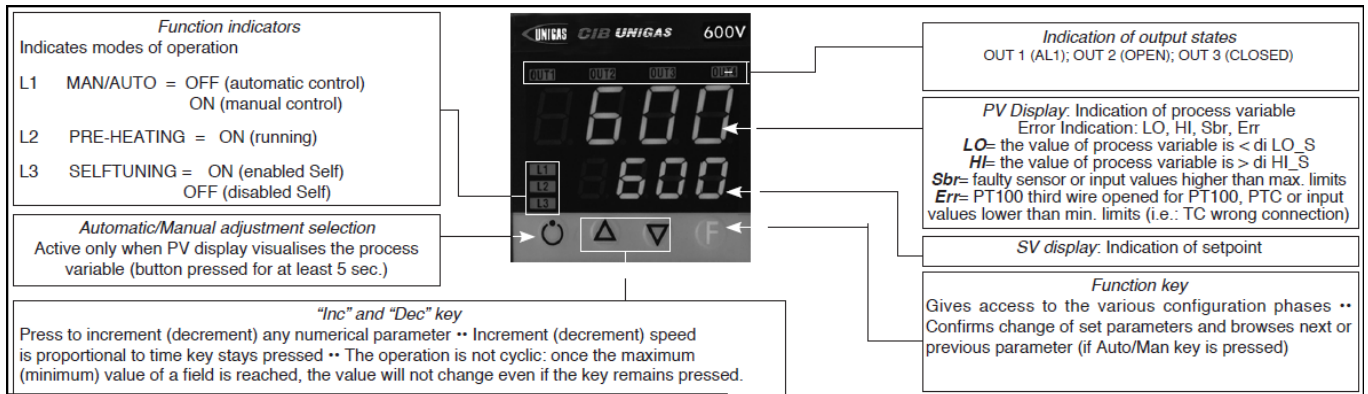

Regulation of the set-point = **80**

It can be modified by using arrows "up" and "down".

By pushing **F** you go to parameters:

Hy.P	10 (hysteresis positive for output 1 terminals 21-22 (ex Q13-Q14))
Hy.n	-5 (hysteresis negative for output 1 terminals 21-22 (ex Q13-Q14))

Keep pushing **F** until you see **PASS**, release **F** and through the arrows set **99**, push **F** and visualize **Pro** (protection code) default is **12**, through the arrows set **128** and push **F**, keep it pushed until all parameters **InF**, **CFG**, **InP**, **Out**, **PASS** are visualized.

CFG	
S.tun	0
hPb	1,2
hIt	5,83
hdt	1,33
...	

InP	
....	
tyP	30 (Pt100)
...	
dP_S	1 (decimals num.)
Lo.S	0 (min. sensor scale)
Hi.S	850,0 (max sensor scale)
oFS	0 (offset of input correction)
Lo.L	0,0 (lower set-point range limit)
Hi.L	350,0 (upper set-point range limit)

Out	
A1.r	0
...	
A1.t	3 (mode AL1 =inverse-relative-normal)
...	
rL.1	2 (AL1)
rL.2	18 (open)
rL.3	19 (close)
rEL	0
A.ty	9 (type of servocontrol command)
Ac.t	12 (servocontrol running time: SQN72.4.../STA12..=12; SQM40.265=30)
t Lo	2
t Hi	0.0
t.on	2
t.oF	0.0
dE.b	0,1 (dead zone in % of end scale)

PAS	99 then push and keep pushed F until visualization of Hrd
Hrd	
...	
Ctrl	6 (PID warm)
AL.nr	1
but	1
diSP	0
Ld.1	1
Ld.2	28
Ld.3	20

Keep pushed **F** until you visualize **PASS**, release **F** and through the arrows set **99**, push **F** and visualize **Pro** (protection code) from **128**, through the arrows, bring it back to **12**, and keep **F** pushed until you come back to set-point value.

Manual operation:

Keep pushed the lower left key for at least 5 sec.

The instrument will enter the "MAN" mode (see also "Ld1" switching on).

Through the arrows, "Open" and "Close" outputs are activated.

To come back to normal working keep the lower left key pushed for at least 5 sec.

Software switch off :

By keeping pushed keys **Arrow up** + **F** for more than 5 sec. the instrument switches off the software, does not command the outputs and visualize only the variable of process measured by the probe.

To restore keep pushed **F** for more than 5 sec.

Set up for pressure transmitter 2 wires signal 4÷20mA

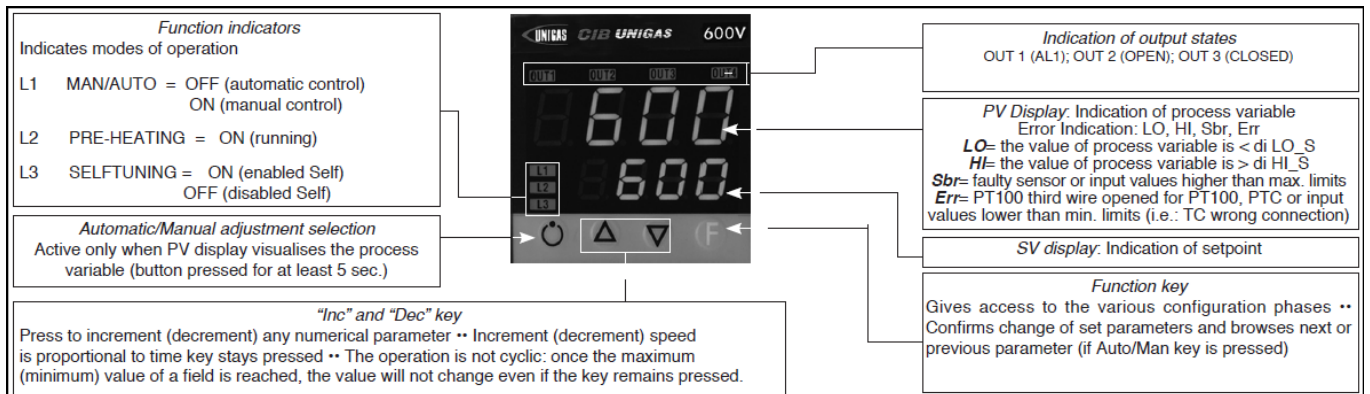

With pressure transmitters first we need to enable their power supply: remove the part as shown below, then, on the CPU unit, move the bridge from Pt100 to +Vt

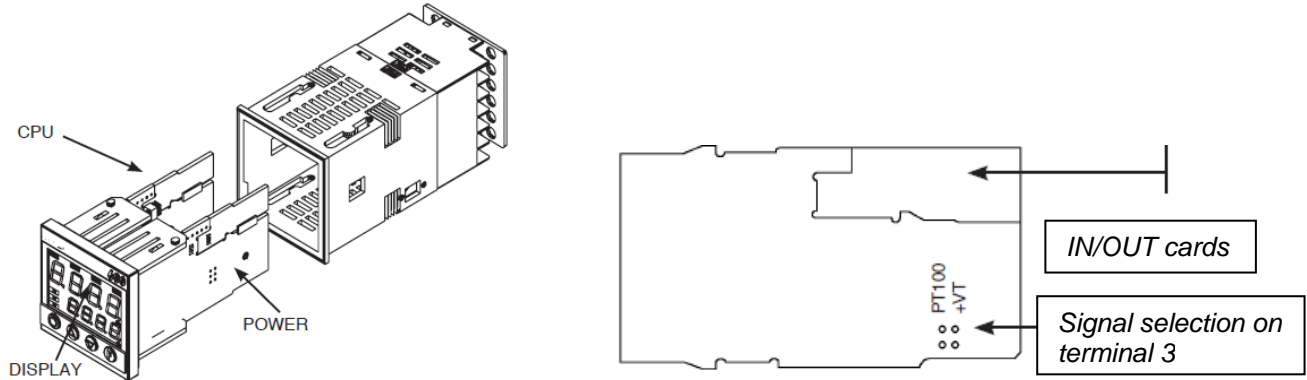

Verify wiring of the sensor

Impostazione set-point

Transmitter	1,6bar	3bar	10bar	16bar	25bar	40bar
Set-point	1bar	1,5bar	6bar	6bar	6bar	6bar

To modify it directly use "up" and "down" arrows.

By pushing **F** you go to parameter:

Transmitter	1,6bar	3bar	10bar	16bar	25bar	40bar
Hy.P	0,2bar	0,5bar	0,5bar	0,8bar	1,25bar	2bar
Hy.n	0bar	0bar	0bar	0bar	0bar	0bar

Keep pushing **F** until you see **PASS**, release **F** and through the arrows set **99**, push **F** and visualize **Pro** (protection code) default is **12**, through the arrows set **128** and push **F**, keep it pushed until all parameters **InF**, **CFG**, **InP**, **Out**, **PASS** are visualized.

CFG	
S.tun	0
hPb	5
hIt	1,33
hdt	0,33
...	

InP	
....	
tyP	44 (4÷20mA)
...	
dP_S	2 (decimals num.)

Transmitter	1,6bar	3bar	10bar	16bar	25bar	40bar	
Lo.S	0,00	0,00	0,00	0,00	0,00	0,00	min. sensor scale
Hi.S	1,60	3,00	10,00	16,00	25,00	40,00	max sensor scale
oFS	0	0	0	0	0	0	offset of input correction
Lo.L	0,00	0,00	0,00	0,00	0,00	0,00	lower set-point setting
Hi.L	1,60	3,00	10,00	16,00	25,00	40,00	upper set-point setting

Out	
A1.r	0
...	
A1.t	3 (mode AL1 =inverse-relative-normal)
...	
rL.1	2 (AL1)
rL.2	18 (open)
rL.3	19 (close)
rEL	0
A.ty	9 (type of servocontrol command)
Ac.t	12 (servocontrol running time: SQN72.4.../STA12..=12; SQM40.265=30)
t Lo	2
t Hi	0.0
t.on	2
t.oF	0.0
dE.b	0,1 (dead zone in % of end scale)

PAS	
	99 then push and keep pushed F until visualization of Hrd
Hrd	
...	
Ctrl	6 (PID warm)
AL.nr	1
but	1
diSP	0
Ld.1	1
Ld.2	28
Ld.3	20

Keep pushed **F** until you visualize **PASS**, release **F** and through the arrows set **99**, push **F** and visualize **Pro** (protection code) from **128**, through the arrows, bring it back to **12**, and keep **F** pushed until you come back to set-point value.

Manual operation:

Keep pushed the lower left key for at least 5 sec.

The instrument will enter the "MAN" mode (see also "Ld1" switching on).

Through the arrows, "Open" and "Close" outputs are activated.

To come back to normal working keep the lower left key pushed for at least 5 sec.

Software switch off :

By keeping pushed keys **Arrow up** + **F** for more than 5 sec. the instrument switches off the software, does not command the outputs and visualize only the variable of process measured by the probe.

To restore keep pushed **F** for more than 5 sec.

Set-up for thermocouples type **K** or **J**

Verify wiring of the sensor

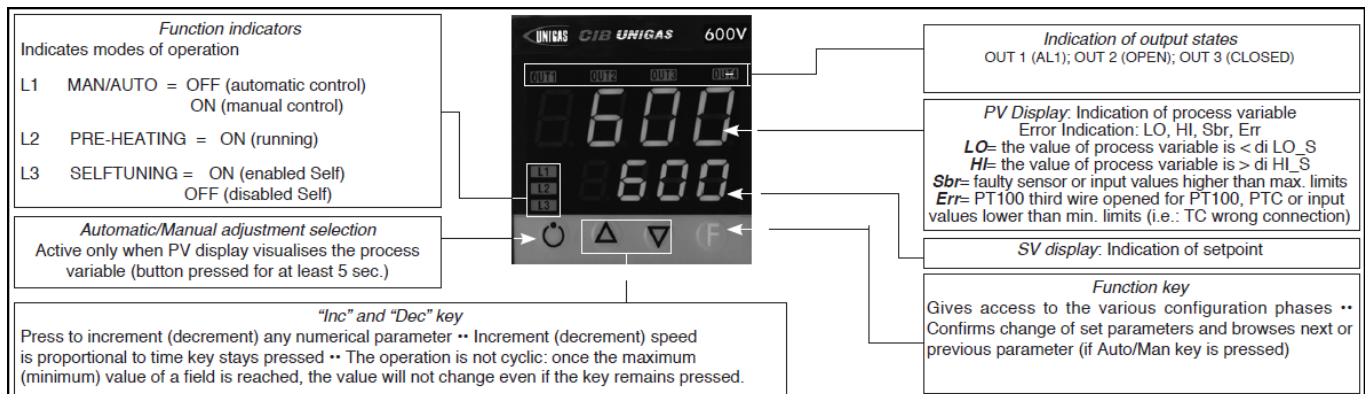

Regulation of the set-point = **80**

It can be modified by using arrows "up" and "down".

By pushing **F** you go to parameters:

Hy.P	10 (hysteresis positive for output 1 terminals 21-22 (ex Q13-Q14))
Hy.n	-5 (hysteresis negative for output 1 terminals 21-22 (ex Q13-Q14))

Keep pushing **F** until you see **PASS**, release **F** and through the arrows set **99**, push **F** and visualize **Pro** (protection code) default is **12**, through the arrows set **128** and push **F**, keep it pushed until all parameters **InF**, **CFG**, **InP**, **Out**, **PASS** are visualized.

CFG	
S.tun	0
hPb	1,2
hIt	5,83
hdt	1,33
...	

InP	
....	
tyP	2 (thermocouple K 0÷1300°C) / 0 (thermocouple J 0÷1000°C)
...	
dP_S	0 (no decimal) / 1 (1 decimal)
Lo.S	0 (min. sensor scale)
Hi.S	1300 (max sensor scale for tc K) / 1000 (max sensor scale for tc J)
oFS	0 (offset of input correction)
Lo.L	0 (lower set-point range limit)
Hi.L	1300 (upper set-point range limit) per tc K / 1000 for tc J

Out	
A1.r	0
...	
A1.t	3 (mode AL1 =inverse-relative-normal)
...	
rL.1	2 (AL1)
rL.2	18 (open)
rL.3	19 (close)
rEL	0
A.ty	9 (type of servocontrol command)
Ac.t	12 (servocontrol running time: SQN72.4.../STA12..=12; SQM40.265=30)
t Lo	2
t Hi	0.0
t.on	2
t.oF	0.0
dE.b	0,1 (dead zone in % of end scale)

PAS	99 then push and keep pushed F until visualization of Hrd
...	
Hrd	
...	
Ctrl	6 (PID warm)
AL.nr	1
but	1
diSP	0
Ld.1	1
Ld.2	28
Ld.3	20

Keep pushed **F** until you visualize **PASS**, release **F** and through the arrows set **99**, push **F** and visualize **Pro** (protection code) from **128**, through the arrows, bring it back to **12**, and keep **F** pushed until you come back to set-point value.

Manual operation:

Keep pushed the lower left key for at least 5 sec.

The instrument will enter the "MAN" mode (see also "Ld1" switching on).

Through the arrows, "Open" and "Close" outputs are activated.

To come back to normal working keep the lower left key pushed for at least 5 sec.

Software switch off :

By keeping pushed keys **Arrow up** + **F** for more than 5 sec. the instrument switches off the software, does not command the outputs and visualize only the variable of process measured by the probe.

To restore keep pushed **F** for more than 5 sec.

RWF50.2x & RWF50.3x



User manual

DEVICE INSTALLATION

Install the device using the relevant tools as shown in the figure.

To wire the device and sensors, follow the instructions on the burner wiring diagram.

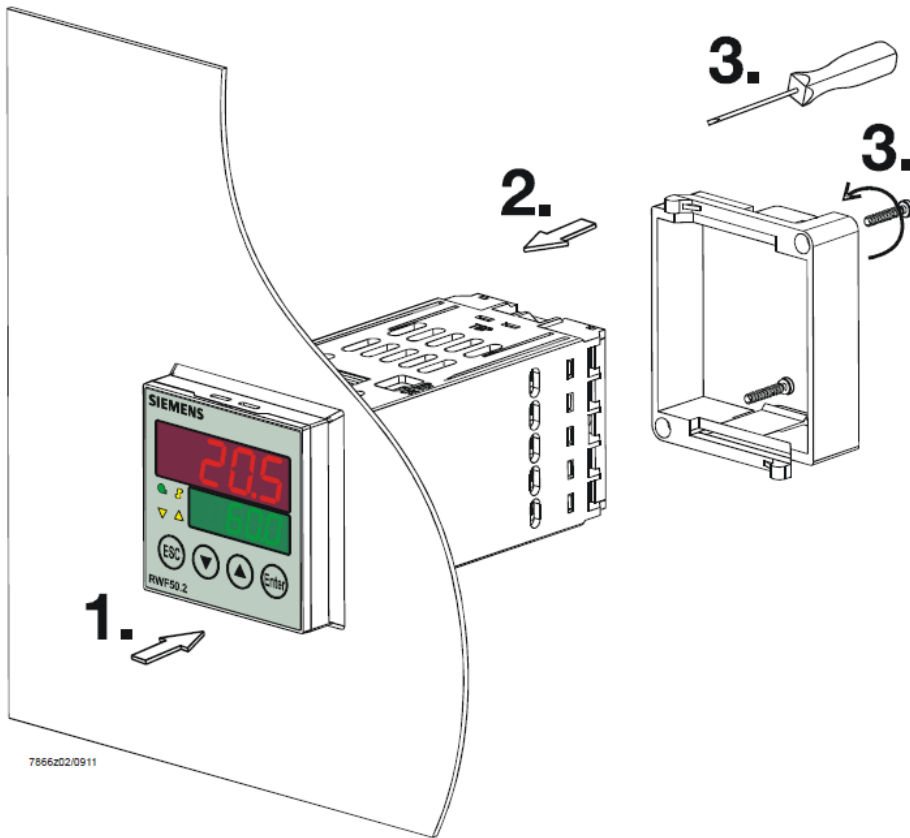

7866202/0911

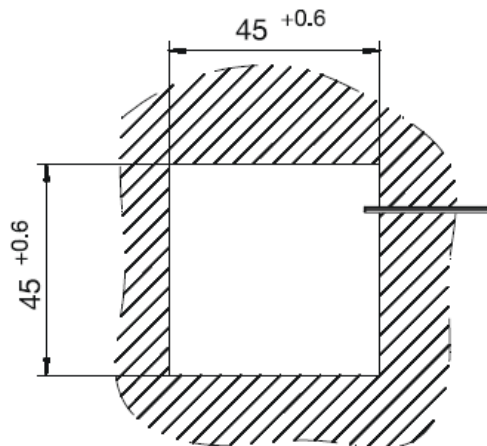

FRONT PANEL

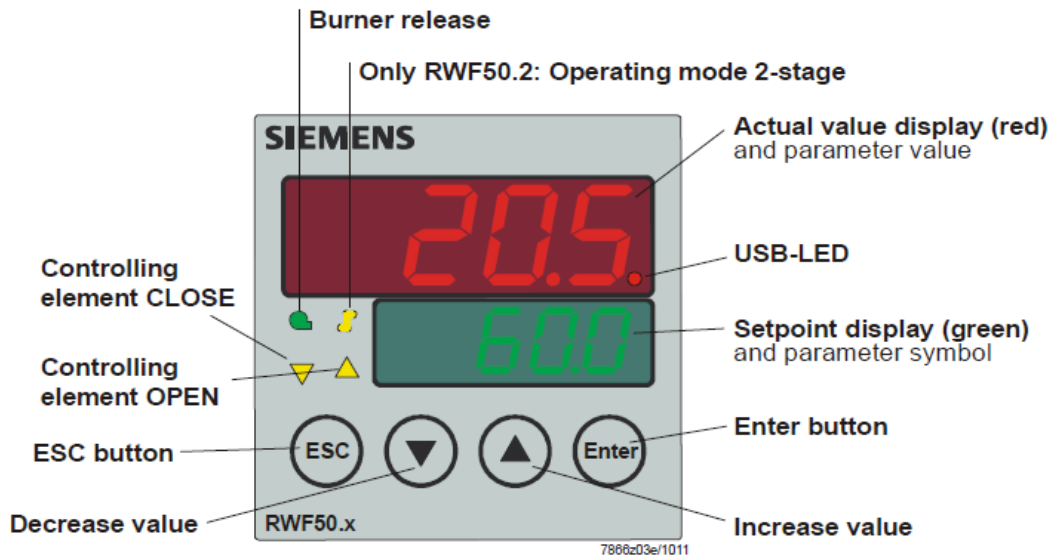

NAVIGATION MENU

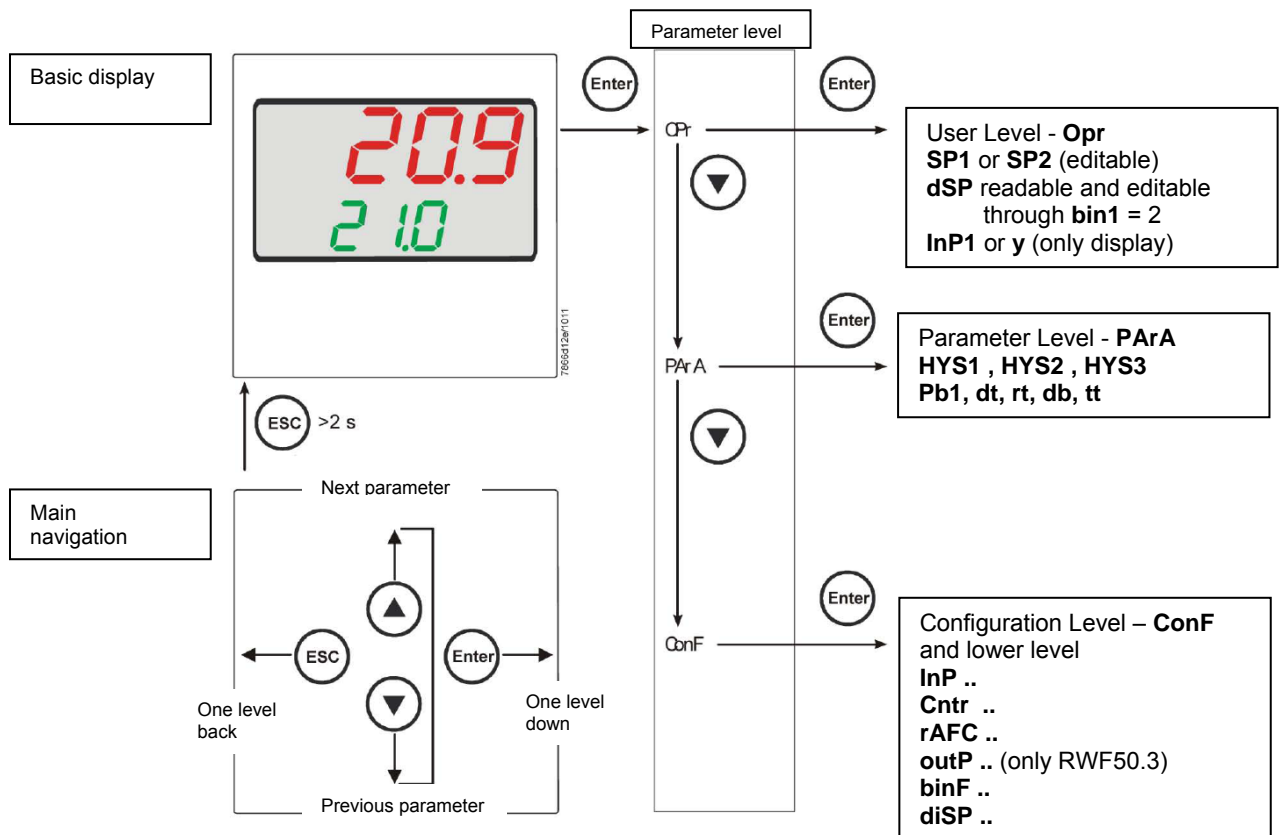

RWF5 is preset good for 90% of applications. However, you can set or edit parameters as follow:

Set-point: set or modification:

When the burner is in stand-by, (safety loop open, that is terminals 3-4/T1-T2 on the 7 pole plug open) push the **Enter** button: on the lower display (green) **Opr** appears; push **Enter** again and in the same display **SP1** appears. Push **Enter** again and the lower display (green **SP1**) flashes. Using the **up and down arrows** change the set-point on the upper display (red). Push **Enter** to confirm and push **ESC** more times to get the home position.

PID parameters set and modifications (see table below):

- Push **Enter** button, on the green display **Opr** appears; using the **down arrow**, scroll until group **PARA** is reached and push **Enter**.
- on the green display **Pb1** e appears and on the red one the set parameter.
- Push in sequence the **down or up** arrow the menu is scrolled.
- Push **Enter** to select and the **arrows** to choose the desired value. **Enter** to confirm.

Parameter	Display	Range	Factory setting	Remarks
Proportional band	PB.1	1... 9999 digit	10	Typical value for temperature
Derivative action	dt	0... 9999 sec.	80	Typical value for temperature
Integral action	rt	0... 9999 sec.	350	Typical value for temperature
Dead band (*)	db	0... 999,9 digit	1	Typical value
Servocontrol running time	tt	10... 3000 sec.	15	Set servocontrol running time
Switch-on differential (*)	HYS1	0,0... -1999 digit	-5	Value under setpoint below which the burner switches back on (1N-1P closes)
Switch-off differential 2° stage (*)	HYS2	0,0 ... HYS3	3	(enable only with parameter bin1 = 4)
Upper switch-off differential (*)	HYS3	0,0... 9999 digit	5	Value over setpoint above which the burner switches off (1N-1P opens)
Switch-on differential on cooling controller (*)	HYS4	0,0... 9999 digit	5	Do not used (enable only with parameter CACT = 0)
Switch-off differential 2° stage on cooling controller (*)	HYS5	HYS6...0,0 digit	5	Do not used (enable only with parameters CACT = 0 and bin1 = 4)
Upper switch-off differential on cooling controller (*)	HYS6	0,0... -1999 digit	5	Do not used (enable only with parameter CACT = 0)
Delay modulation	q	0,0... 999,9 digit	0	Do not alter

(*)Parameters affected by setting of decimal place (**ConF > dISP** parameter **dECP**)

Setting the kind of sensor to be connected to the device:

- push the **Enter** button: on the lower display (green) **Opr** appears. Using the **up and down arrows** find **ConF**. Push **Enter** to confirm.
- Now on the green display the group **InP** appears. Push **Enter** and **InP1** is displayed. Enter to confirm.
- You are inside **InP1**; the green display shows **Sen1 (sensor type)**, while the red display shows the chosen sensor code
- Push **Enter** to enter the **Sen1** parameter, then choose the desired sensor using the **arrows**. Push **Enter** to confirm and **ESC** to escape.
- Once selected the sensor, you can modify all the other parameters using **up and down arrows** according to the tables here below.

ConF > InP > InP1

Parameter	Value	Description
SEn1 type of sensor for analog input 1	1	Pt100 3 fili
	2	Pt100 2 fili
	3	Pt1000 3 fili
	4	Pt1000 2 fili
	5	Ni1000 3 fili
	6	Ni1000 2 fili
	7	0 ÷ 135 ohm
	15	0 ÷ 20mA
	16	4 ÷ 20mA
	17	0 ÷ 10V
	18	0 ÷ 5V
19	1 ÷ 5V	
OFF1 sensor offset	-1999.. 0 .. +9999	Using the measured value correction (offset), a measured value can be corrected to a certain degree, either up or down
SCL1 scale low level	-1999.. 0 .. +9999	In the case of a measuring transducer with standard signal, the physical signal is assigned a display value here (for input ohm, mA, V)
SCH1 scale high level	-1999.. 100 .. +9999	In the case of a measuring transducer with standard signal, the physical signal is assigned a display value here (for input ohm, mA, V)
dF1 digital filter	0.. 0,6 ...100	Is used to adapt the digital 2nd order input filter (time in s; 0 s = filter off)
Unit temperature unit	1 2	1 = degrees Celsius 2 = degrees Fahrenheit

(**bold** = factory settings)

Remark:

RWF50.2 e RWF50.3 cannot be connected to thermocouples.
If thermocouples have to be connected, convert the signal to a 4-20 mA one and set the RWF accordingly.

ConF > Cntr

Parameter	Value	Description
CtYP controller type	1 2	1 = 3-position controller (open-stop-close only RWF50.2) 2 = continuative action controller (only RWF50.3)
CACt control action	1 0	1 = heating controller 0 = cooling controller
SPL least value of the set-point range	-1999.. 0 ..+9999	set-point limitation prevents entry of values outside the defined range
SPH maximum value of the set-point range	-1999.. 100 ..+9999	set-point limitation prevents entry of values outside the defined range
oLLo set-point limitation start, operation limit low	-1999 +9999	lower working range limit
oLHi set-point limitation end, operation limit high	-1999.... +9999	upper working range limit

(**bold** = factory settings)

ConF > rAFC

Activation boiler shock termic protetion:

RWF50.. can activate the thermal shock protection only on sites where the set-point is lower than 250°C and according to **rAL** parameter.

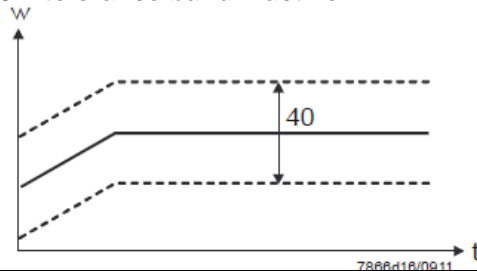
Parameter	Value	Description
FnCT function	0 1 2	Choose type of range degrees/time 0 = deactivated 1 = Kelvin degrees/minute 2 = Kelvin degrees/hour
rASL ramp rate	0,0 ... 999,9	Slope of thermal shock protection (only with functions 1 and 2)
toLP tolerance band ramp	0 ...9999	width of tolerance band (in K) about the set-point 0 = tolerance band inactive 
rAL ramp limit	0 ...250	Ramp limit. When this value is lower than the temperature set-point, the RWF controls the output increasing the temp set point step by step according to rASL. If this is over the temp set point, the control is performed in cooling.

(**bold** = factory settings)

ConF > OutP (parameter under group only for RWF50.3)

Parameter	Value	Description
FnCt tipo di controllo	1 4	1 = analog input 1 doubling with possibility to convert (depending on par SiGn) 4 = modulation controller
SiGn type of output signal	0 1 2	physical output signal (terminals A+, A-) 0 = 0÷20mA 1 = 4÷20mA 2 = 0÷10V
rOut Value when out of input range	0...101	signal (in percent) when measurement range is crossed
oPnt zero point	-1999... 0 ..+9999	value range of the output variable is assigned to a physical output signal Per default, the setting corresponds to 0...100% angular positioning for the controller outputs (terminals A+, A-) (effective only with FnCt = 1)
End End value	-1999... 100 ..+9999	value range of the output variable is assigned to a physical output signal Per default, the setting corresponds to 0...100% angular positioning for the controller outputs (terminals A+, A-) (effective only with FnCt = 1)

(**bold** = factory settings)

ConF > binF

Parameter	Value	Description
bin1 digital inputs (terminals DG - D1)	0 1 2 4	0 = without function 1 = set-point changeover (SP1 / SP2) 2 = set-point shift (Opr > dSP parameter = value of set-point modify) 4 = changeover of operating mode open – modulating operation; close – 2 stage operation.

(**bold** = factory settings)

ConF > dISP

Parameter	Value	Description
diSU upper display (red)	0 1 4 6 7	display value for upper display: 0 = display power-off 1 = analog input value 4 = Controller's angular positioning 6 = set-point value 7 = end value with thermal shock protection
diSL lower display (green)	0 1 4 6 7	display value for lower display: 0 = display power-off 1 = analog input value 4 = Controller's angular positioning 6 = set-point value 7 = end value with thermal shock protection
tout timeout	0.. 180 ..250	time (s) on completion of which the controller returns automatically to the basic display, if no button is pressed
dECP decimal point	0 1 2	0 = no decimal place 1 = one decimal place 2 = two decimal places
CodE level lockout	0 1 2 3	0 = no lockout 1 = configuration level lockout (ConF) 2 = Parameter and configuration level lockout (PArA & ConF) 3 = keyboard lockout

(**bold** = factory settings)

Manual control :

- in order to manual change the burner load, while firing keep pushing the **ESC** button for more than 5 s; on the lower green display **Hand** appears.
- using the **UP** and **DOWN** arrows, the load varies.
- Keep pushing the **ESC** button for getting the normal operation again.
- **NB:** every time the device shuts the burner down (start led switched off - contact 1N-1P open), the manual control is not active.

Device self-setting (auto-tuning):

If the burner in the steady state does not respond properly to heat generator requests, you can activate the Device's self-setting function, which recalculates PID values for its operation, deciding which are most suitable for the specific kind of request

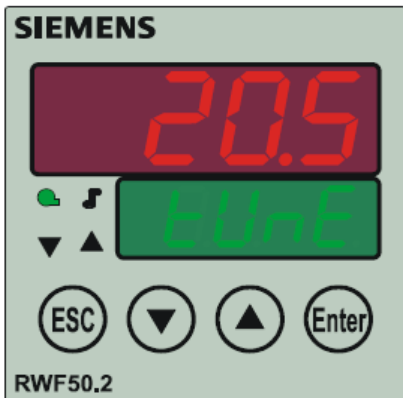

78662d4/0911

Follow the below instructions:

push the **UP** and **DOWN** arrows for more than 5 s; on the green lower display **TUNE** appears. Now the device pushes the burner to increase and decrease its output. During this time, the device calculates PID parameters (**Pb1**, **dt** and **rt**). After the calculations, the TUNE is automatically deactivated and the device has already stored them. In order to stop the Auto-tuning function while it works, push again the **UP** and **DOWN** arrows for more than 5 s. The calculated PID parameters can be manually modified following the previously described instructions.

Display of software version :



78662d5/0911

The software version is shown by pushing **Enter + UP arrow** on the upper display

Electric connection :

With 7 pins connector version

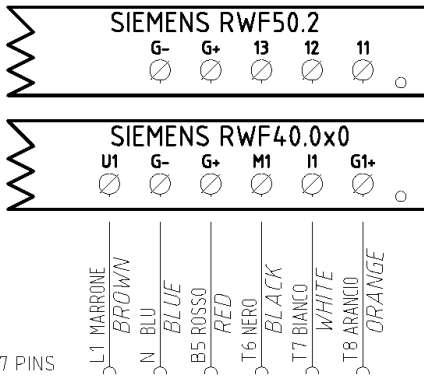

CONN. 7 PINS

With terminals version

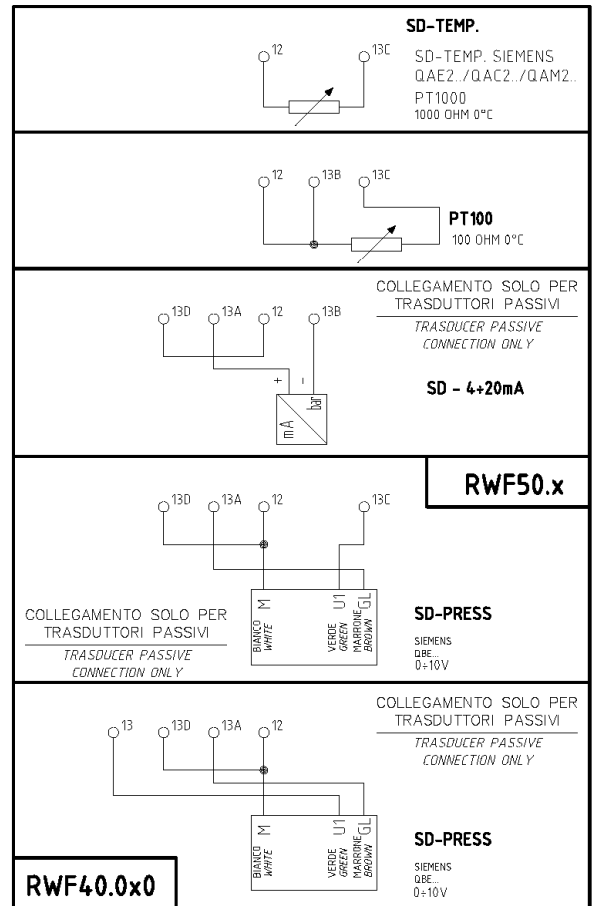
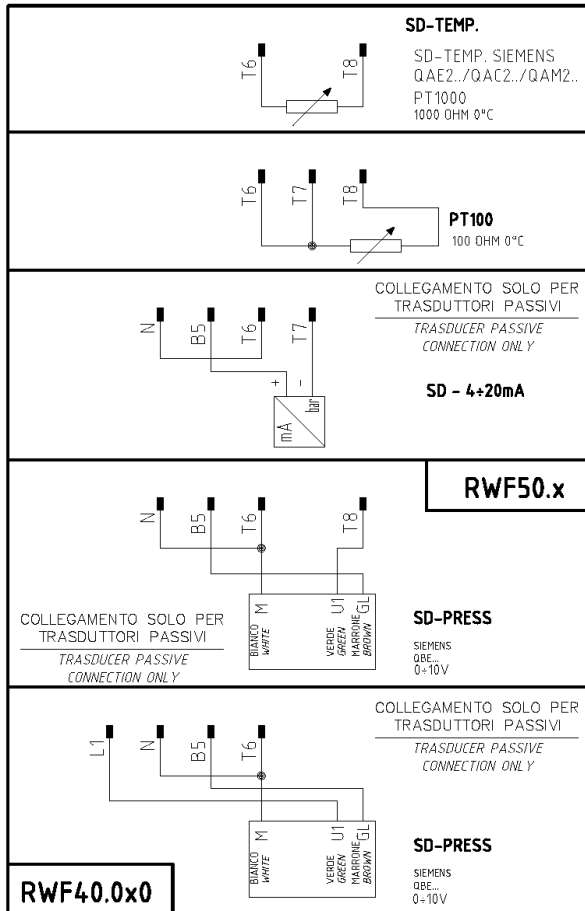
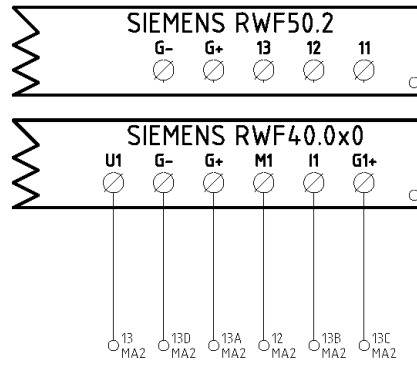

Matches terminals between RWF50.2 and RWF40.0x0

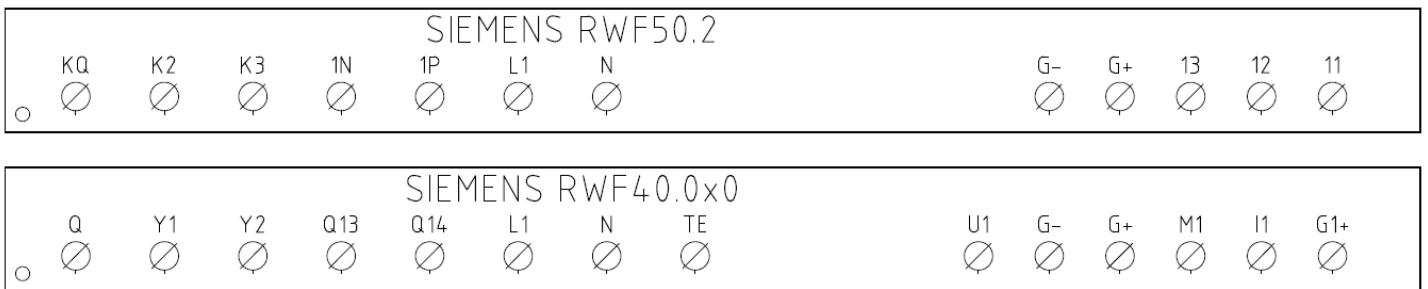

Parameters summarising for RWF50.2x:

Navigation menù	Conf Inp					Conf			PArA					Opr	
	Inp1					Cntr		diSP							
Types of probe	SEn1	OFF1	SCL	SCH	Unit	SPL	SPH	dECP	Pb. 1	dt	rt	tt	HYS1 (*)	HYS3 (*)	SP1 (*)
Siemens QAE2120...	6	0	needless	needless	1	30	95	1	10	80	350 (#)		-5	5	80 °C
Siemens QAM2120..	6	0	needless	needless	1	0	80	1	10	80	350 (#)		-2.5	2.5	40°C
Pt1000 (130°C max.)	4	0	needless	needless	1	30	95	1	10	80	350 (#)		-5	5	80°C
Pt1000 (350°C max.)	4	0	needless	needless	1	0	350	1	10	80	350 (#)		-5	10	80°C
Pt100 (130°C max.)	1	0	needless	needless	1	0	95	1	10	80	350 (#)		-5	5	80°C
Pt100 (350°C max)	1	0	needless	needless	1	0	350	1	10	80	350 (#)		-5	10	80°C
Sonda 4÷20mA / 0÷1,6bar	16	0	0	160	needless	0	160	0	5	20	80 (#)		0	20	100 kPa
Sonda 4÷20mA / 0÷10bar	16	0	0	1000	needless	0	1000	0	5	20	80 (#)		0	50	600 kPa
Sonda 4÷20mA / 0÷16bar	16	0	0	1600	needless	0	1600	0	5	20	80 (#)		0	80	600 kPa
Sonda 4÷20mA / 0÷25bar	16	0	0	2500	needless	0	2500	0	5	20	80 (#)		0	125	600 kPa
Sonda 4÷20mA / 0÷40bar	16	0	0	4000	needless	0	4000	0	5	20	80 (#)		0	200	600 kPa
Sonda 4÷20mA / 0÷60PSI	16	0	0	600	needless	0	600	0	5	20	80 (#)		0	30	300 (30PSI)
Sonda 4÷20mA / 0÷200PSI	16	0	0	2000	needless	0	2000	0	5	20	80 (#)		0	75	600 (60PSI)
Sonda 4÷20mA / 0÷300PSI	16	0	0	3000	needless	0	3000	0	5	20	80 (#)		0	120	600 (60PSI)
Siemens QBE2002 P4	17	0	0	400	needless	0	400	0	5	20	80 (#)		0	20	200 kPa
Siemens QBE2002 P10	17	0	0	1000	needless	0	1000	0	5	20	80 (#)		0	50	600 kPa
Siemens QBE2002 P16	17	0	0	1600	needless	0	1600	0	5	20	80 (#)		0	80	600 kPa
Siemens QBE2002 P25	17	0	0	2500	needless	0	2500	0	5	20	80 (#)		0	125	600 kPa
Siemens QBE2002 P40	17	0	0	4000	needless	0	4000	0	5	20	80 (#)		0	200	600 kPa
Segnale 0÷10V	17	0	to be fixed	to be fixed	needless	to be fixed	to be fixed	to be fixed	5	20	80 (#)		to be fixed	to be fixed	to be fixed
Segnale 4÷20mA	16	0	to be fixed	to be fixed	needless	to be fixed	to be fixed	to be fixed	5	20	80 (#)		to be fixed	to be fixed	to be fixed

NOTE : (#) tt - Types of probe

SQL33 ; STM30; SQM10; SQM40; SQM50; SQM54 = 30 (second) - STA12B3.41; SQN30.251; SQN72.4A4A20 = 12 (second)

(*) These values are factory set - values **MUST BE** set during operation at the plant based on the real working temperature/pressure value.

WARNING : With pressure probes the parameters SP1, SCH, SCL, HYS1, HYS3 must be selected, and visualized in kPa (kilo Pascal). (1bar = 100.000Pa = 100kPa).

TABLE OF PARAMETERS TO BE MODIFIED FOR CALIBRATIONS RWF50.3x/RWF55.xx (CONTINUOUS OUTPUT 4÷20mA) INSTEAD OF 3 POINTS

Navigation menù	Conf OutP				
Parameter	FnCt	SiGn	rOut	OPnt	End
	4	1 (4÷20mA)	0	0	100

NOTE : (#) tt - servocontrol travel time

SQL33 ; STM30; SQM10; SQM40; SQM50; SQM54 = 30 (second)

STA12B3.41; SQN30.251; SQN72.4A4A20 = 12 (second)

(*) Factory-set values, these values must be varied according to the actual working temperature/pressure of the system.

WARNING : With pressure probes in bar, parameters SP1, SCH, SCL, HYS1, HYS3 must be set, and displayed in kPa (kilo Pascal); 1bar = 100,000Pa = 100kPa.
With pressure probes in PSI the parameters SP1, SCH, SCL, HYS1, HYS3 must be set, and displayed in PSI x10 (example : 150PSI > display 1500).

APPENDIX: PROBES CONNECTION

To assure the utmost comfort, the control system needs reliable information, which can be obtained provided the sensors have been installed correctly. Sensors measure and transmit all variations encountered at their location.

Measurement is taken based on design features (time constant) and according to specific operating conditions. With wiring run in raceways, the sheath (or pipe) containing the wires must be plugged at the sensor's terminal board so that currents of air cannot affect the sensor's measurements.

Ambient probes (or ambient thermostats)

Installation

The sensors (or room thermostats) must be located in reference rooms in a position where they can take real temperature measurements without being affected by foreign factors.

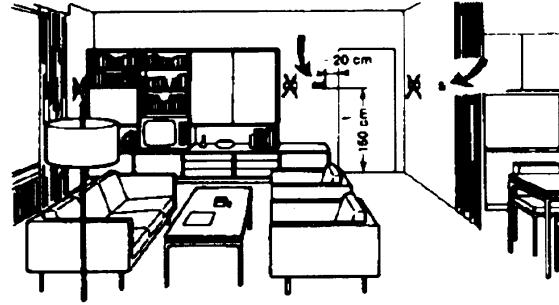
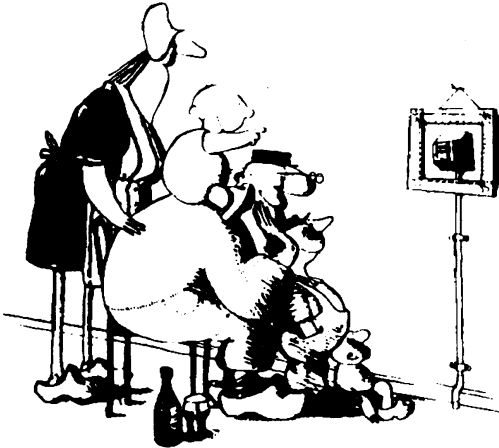

Outside probes (weather)

Installation

In heating or air-conditioning systems featuring adjustment in response to outside temperature, the sensor's positioning is of paramount importance.

It's good to be admired ...even better to be effective

Heating systems: the room sensor must not be installed in rooms with heating units complete with thermostatic valves. Avoid all sources of heat foreign to the system.

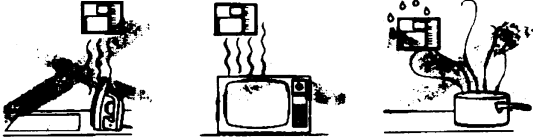

General rule: on the outer wall of the building where the living rooms are, never on the south-facing wall or in a position where they will be affected by morning sun. If in any doubt, place them on the north or north-east façade.

Location

On an inner wall on the other side of the room to heating units height above floor 1.5 m, at least 1.5 m away from external sources of heat (or cold).

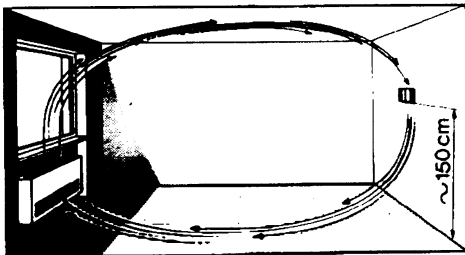

Installation position to be avoided

near shelving or alcoves and recesses, near doors or windows, inside outer walls exposed to solar radiation or currents of cold air, on inner walls with heating system pipes, domestic hot water pipes, or cooling system pipes running through them.

Positions to be avoided

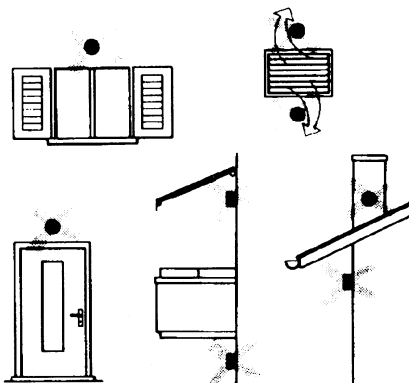

Avoid installing near windows, vents, outside the boiler room, on chimney breasts or where they are protected by balconies, cantilever roofs.

The sensor must not be painted (measurement error).

Duct or pipe sensors

Installing temperature sensors

For measuring outlet air:

- after delivery fan or
- after coil to be controlled, at a distance of at least 0,5 m

For measuring room temperature:

- before return air intake fan and near room's return airintake. For measuring saturation temperature: after mist eliminator.

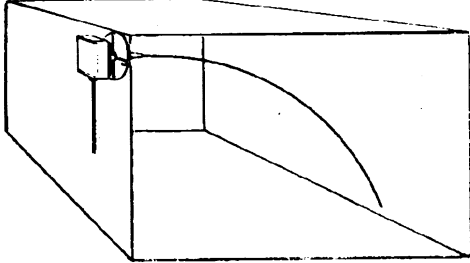

Bend 0.4m sensor by hand (never use tools) as illustrated.

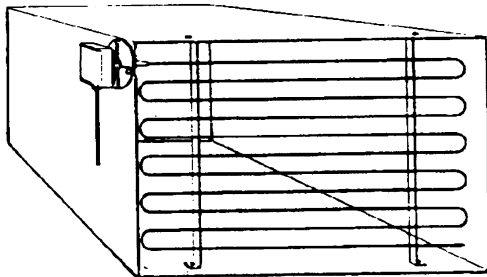

Use whole cross-section of duct, min. distance from walls 50 mm, radius of curvature 10 mm for 2m or 6m sensors.

Installing combined humidity sensors

As max. humidity limit sensor on outlet (steam humidifiers).

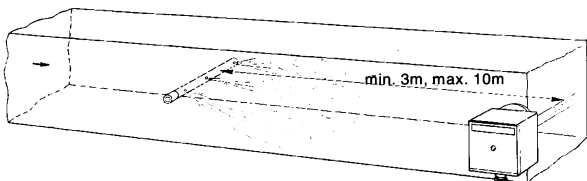

Installing pressure sensors

A - installation on ducts carrying fluids at max. temperature 80°C

B - installation on ducts at temperature over 80°C and for refrigerants

C - installation on ducts at high temperatures:

- increase length of siphon
- place sensor at side to prevent it being hit by hot air coming from the pipe.

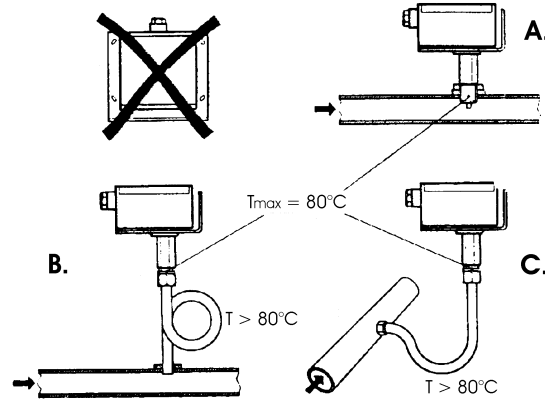

Installing differential pressure sensors for water

- Installation with casing facing down not allowed.-With temperature over 80°C, siphons are needed.
- To avoid damaging the sensor, you must comply with the following instructions

when installing:

- make sure pressure difference is not greater than thevalue permitted by the sensor
- when there are high static pressures, make sure you insert shutoff valves A-B-C.

Putting into operation

Start disable

1=open C1=open C

2=open A2=close B

3=open B3=close A

4= close C

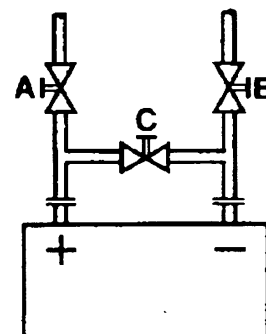

Immersion or strap-on sensors

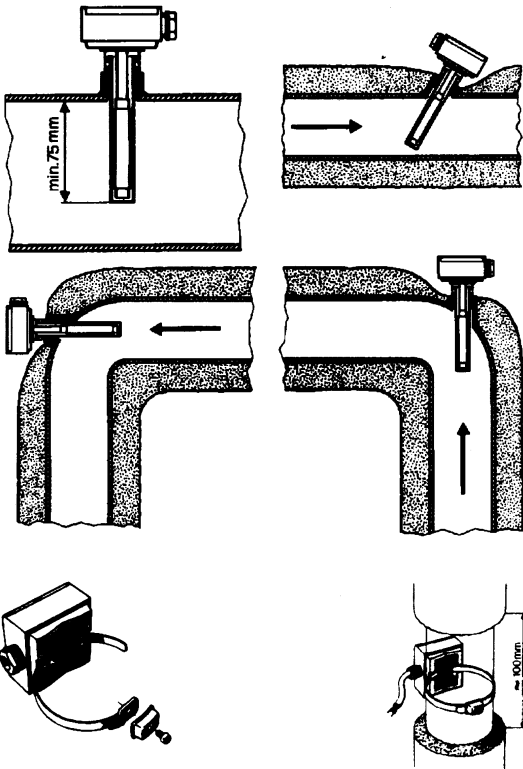

Immersion probes installation

Sensors must be installed on the stretch of pipe in which fluid circulates all the time.

The rigid stem (sensing element doing the measuring) must be inserted by at least 75mm and must face the direction of flow.

Recommended locations: on a bend or on a straight stretch of pipe but tilted by 45° and against the flow of fluid.

Protect them to prevent water from infiltrating (dripping gates, condensation from pipes etc.)

Installing QAD2.. strap-on sensors

Make sure fluid is circulating in the chosen location.

Eliminate insulation and paintwork (including rust inhibitor) on a min. 100mm length of pipe.

Sensors come with straps for pipes up to 100 mm in diameter

Placing the probes (QAD22.../QAE21.../QAP21.../RCA...)

With pumps on outlet

with 3 ways valves / with 4 ways valves



Panel system / burner control

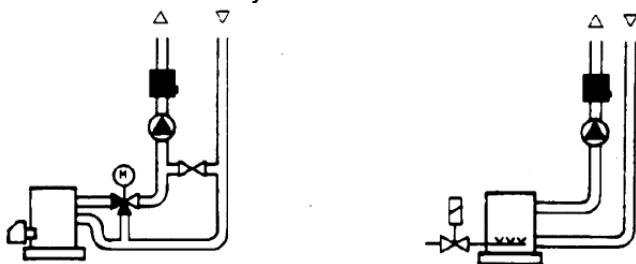

With pumps on return

with 3 ways valves / with 4 ways valves



Strap-on or immersion sensors?

QAD2.. strap-on sensors

Advantages :

- 10 sec. time constant
- Installed with system running (no plumbing work)
- Installation can be changed easily if it proves incorrect.

Limits:

- Suitable for pipe diameters max. 100 mm
- Can be affected by currents of air etc.

QAE2... immersion sensors

Advantages:

- Measure "mean" fluid temperature
- No external influence on measurement such as: currents of air, nearby pipes etc.

Limits:

- Time constant with sheath: 20 sec.
- Hard to change installation position if it proves incorrect.

Duct pressure switches and sensors

Installing differential pressure probes for air

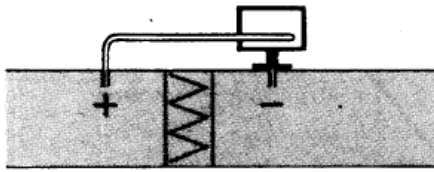

A - Control a filter (clogging)

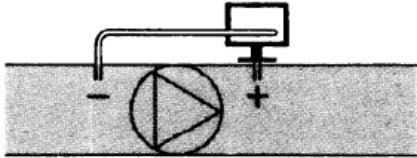

B - Control a fan (upstream/downstream)

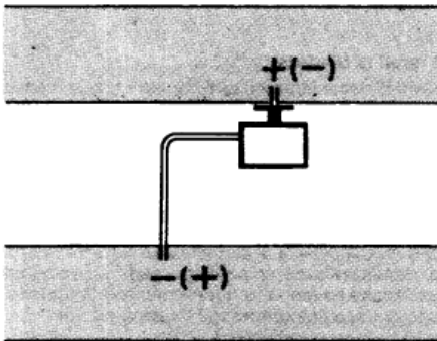

C - Measurement of difference in pressure between two ducts

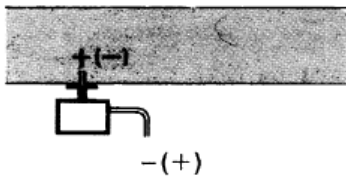

D - Measurement of difference in pressure between two rooms or of inside of duct and outside

Basic principles

Measuring static pressure (i.e. pressure exerted by air on pipe walls)

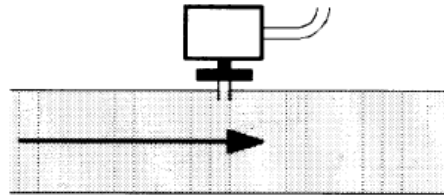

Measuring dynamic pressure

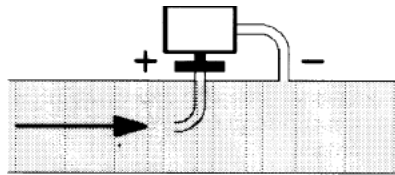

$$Pd = \frac{\gamma v^2}{2g}$$

Key

- γ Kg/m³, specific weight of air
- v m/s, air speed
- g 9.81 m/s² gravity acceleration
- Pd mm C.A., dynamic pressure

Measuring total pressure

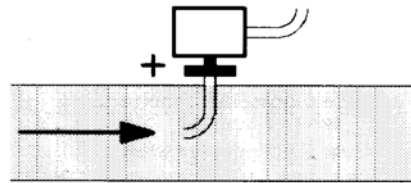

Spare parts

Description	Code
Modulator RWF50.2 (uscita a 3 punti - apri, fermo, chiudi) 2570148	2570148
Modulator RWF50.3 (uscita continua 0÷20mA, 4÷20mA, 0÷10V) 2570149	2570149
Temperature probe Siemens QAE2120.010A (30÷130°C) 2560101	2560101
Temperature probe Siemens QAM2120.040 (-15÷+50°C) 2560135	2560135
Thermoresistor Pt1000 ø6mm L100mm (30÷130°C) 2560188	2560188
Thermoresistor Pt1000 ø10mm L200mm (0÷350°C) 2560103	2560103
Thermoresistor Pt100 ø10mm L200mm (0÷350°C) 2560145	2560145
Thermoresistor Pt100 ø8mm L85mm (0÷120°C) 25601C3	25601C3
Pressure probe Siemens QBE2.. P4 (0÷4bar) 2560159	2560159
Pressure probe Siemens QBE2.. P10 (0÷10bar / signal 0÷10V) 2560160	2560160
Pressure probe Siemens QBE2.. P16 (0÷16bar / signal 0÷10V) 2560167	2560167
Pressure probe Siemens QBE2.. P25 (0÷25bar / signal 0÷10V) 2560161	2560161
Pressure probe Siemens QBE2.. P40 (0÷40bar / signal 0÷10V) 2560162	2560162
Pressure probe Danfoss MBS 3200 P 1,6 (0÷1,6bar / signal 4÷20mA) 2560189	2560189
Pressure probe Danfoss MBS 3200 P 10 (0÷10bar / signal 4÷20mA) 2560190	2560190
Pressure probe Danfoss MBS 3200 P 16 (0÷16bar / signal 4÷20mA) 2560191	2560191
Pressure probe Danfoss MBS 3200 P 25 (0÷25bar / signal 4÷20mA) 2560192	2560192
Pressure probe Danfoss MBS 3200 P 40 (0÷40bar / signal 4÷20mA) 2560193	2560193
Pressure probe Siemens 7MF1565-3BB00-1AA1 (0÷1,6bar / signal 4÷20mA) 25601A3	25601A3
Pressure probe Siemens 7MF1565-3CA00-1AA1 (0÷10bar / signal 4÷20mA) 25601A4	25601A4
Sonda di pressione Siemens 7MF1565-3CB00-1AA1 (0÷16bar / signal 25601A5	25601A5
Pressure probe Siemens 7MF1565-3CD00-1AA1 (0÷25bar / signal 4÷20mA) 25601A6	25601A6
Pressure probe Siemens 7MF1565-3CE00-1AA1 (0÷40bar / signal 4÷20mA) 25601A7	25601A7
Pressure probe Gefran E3E B1V6 MV (0÷1,6bar / segnale 4÷20mA) 25601C4	25601C4
Pressure probe Danfoss E3E B01D MV (0÷10bar / segnale 4÷20mA) 25601C5	25601C5
Pressure probe Danfoss E3E B16U MV (0÷16bar / segnale 4÷20mA) 25601C6	25601C6
Pressure probe Danfoss E3E B25U MV (0÷25bar / segnale 4÷20mA) 25601C7	25601C7
Pressure probe Danfoss E3E B04D MV (0÷40bar / segnale 4÷20mA) 25601C8	25601C8
Pressure probe Siemens 7MF1567-4CD00-1EA1 (0-300PSI 1/4NPT 4-20mA)	25601G0
Pressure probe Siemens 7MF1567-4BF00-1EA1 (0-60PSI 1/4NPT 4-20mA)	25601G1
Pressure probe Siemens 7MF1567-4CB00-1EA1 (0-200PSI 1/4NPT 4-20mA)	25601G2

Note: Specifications and data subject to change. Errors and omissions excepted.

KM3 Modulator

USER MANUAL

MOUNTING

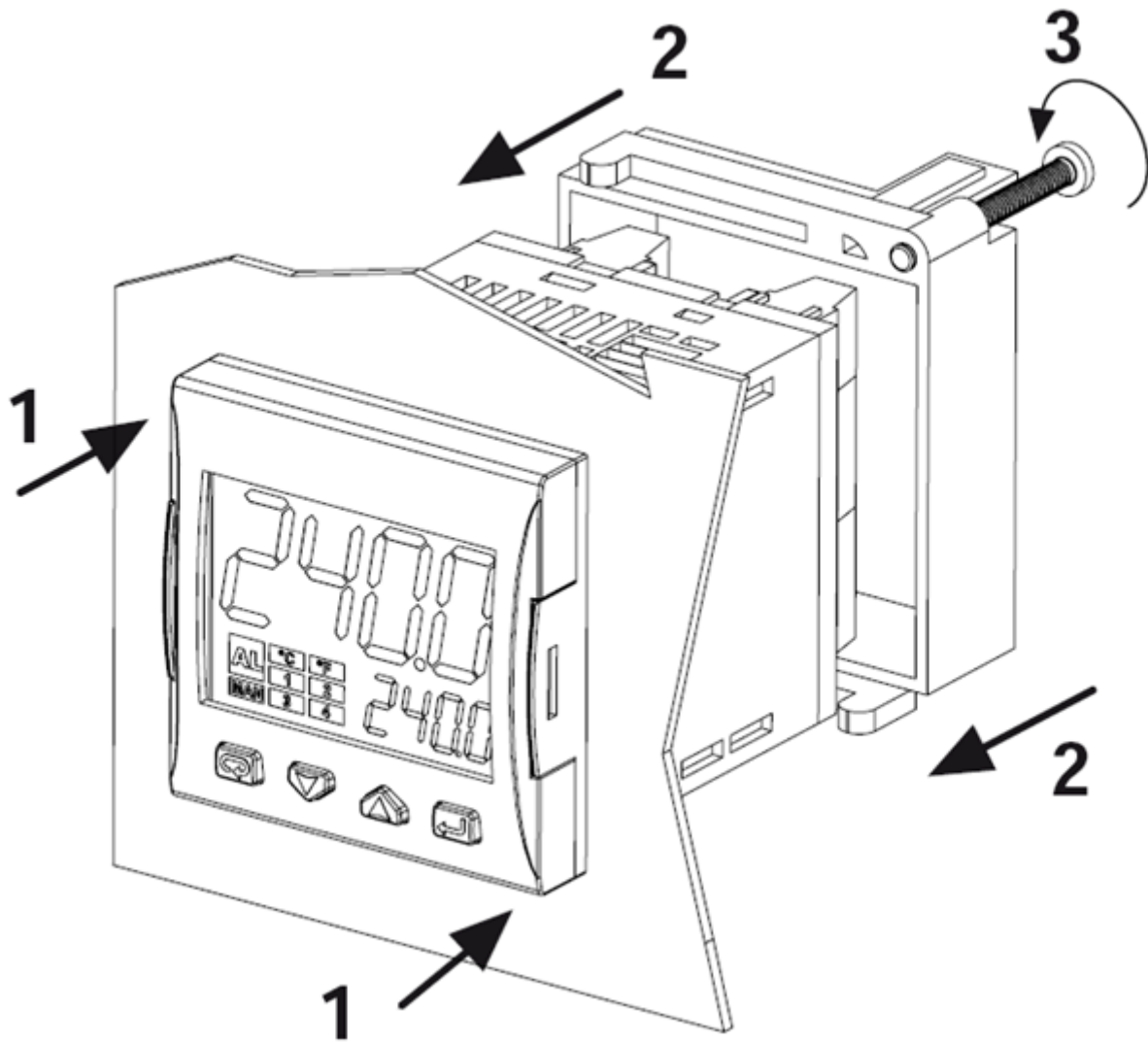

DISPLAY AND KEYS

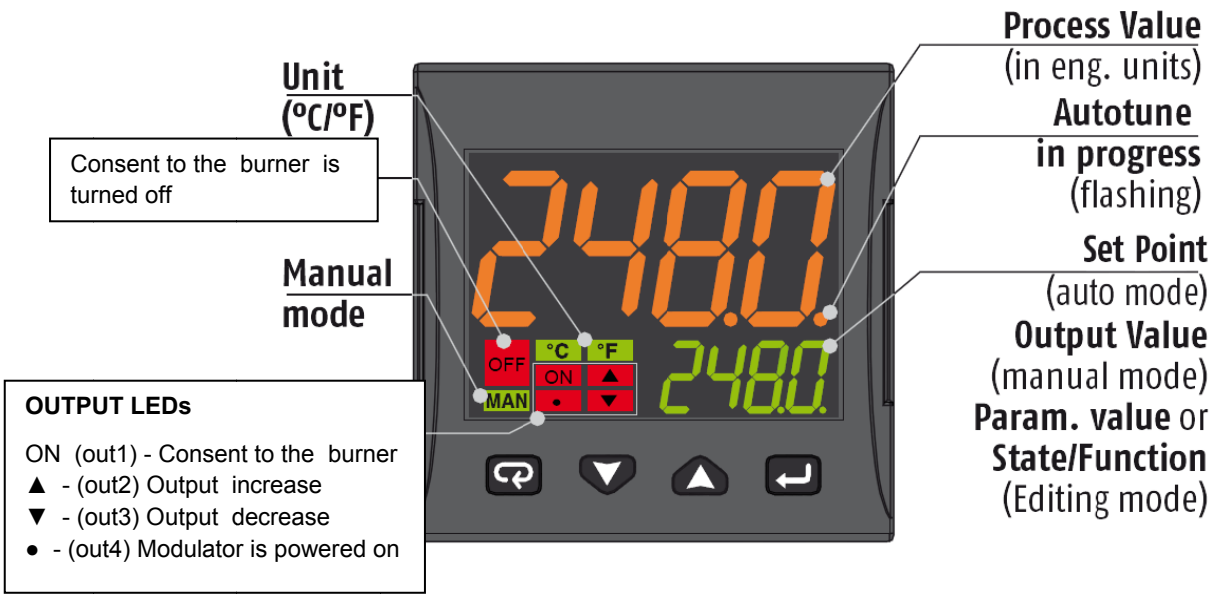

	Operator Mode	Editing Mode
	Access to: - Operator Commands (Timer, Setpoint selection ...) - Parameters - Configuration	Confirm and go to Next parameter
	Access to: - Operator additional information (Output value, running time ...)	Increase the displayed value or select the next element of the parameters list
	Access to: - Set Point	Decrease the displayed value or select the previous element
	Programmable key: Start the programmed function (Autotune, Auto/Man, Timer ...)	Exit from Operator commands/Parameter setting/Configuration

CONNECTIONS DIAGRAM

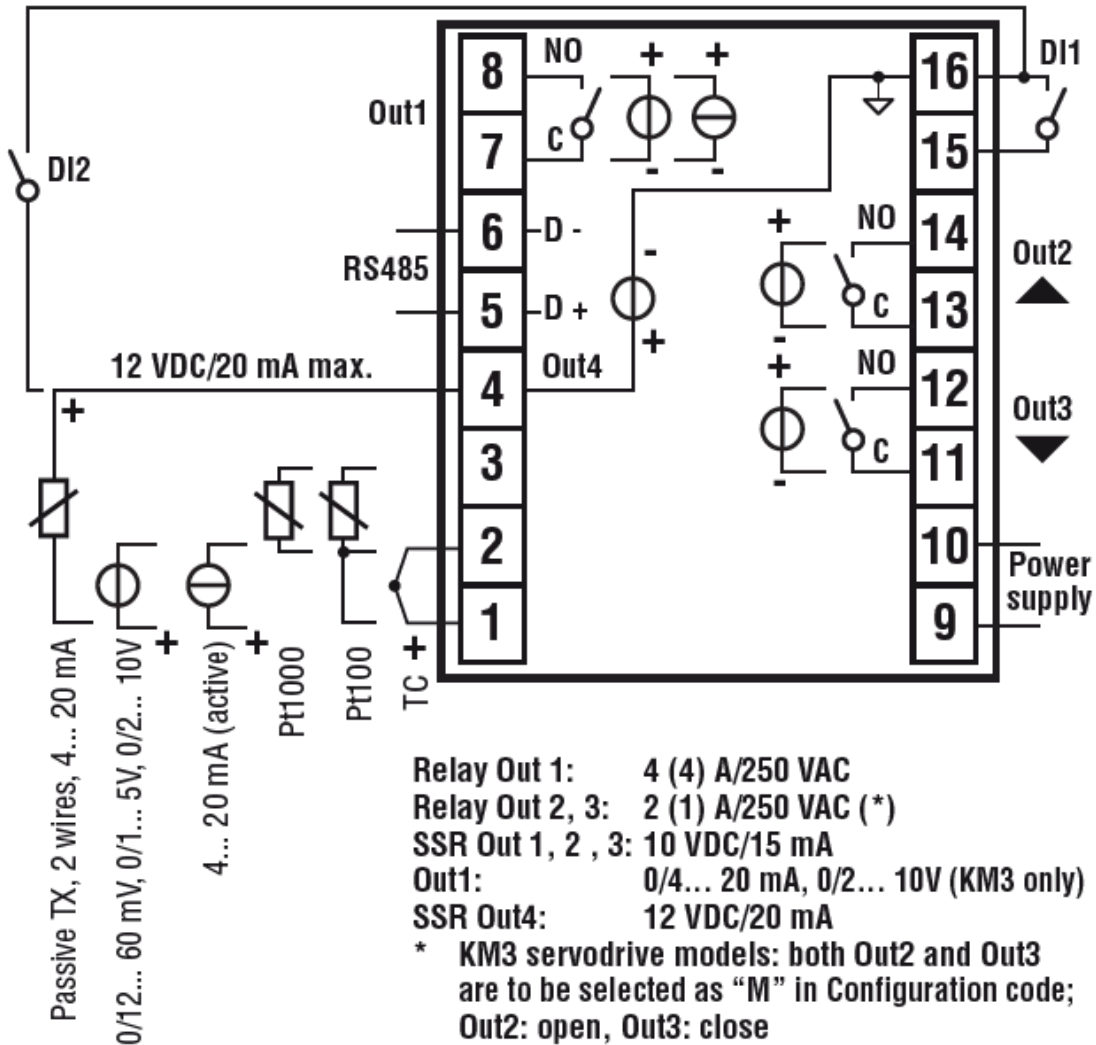

Probe connection:

- **PT1000/NTC/PTC:** between terminal 3 and 2
- **PT 100:** between terminal 3 and 2 with terminal 1
- **Passive pressure probe** 0/4-20 mA: between terminal 4 (+) e 1 (-)
Note: out4 must be activated (IO4F must be setted to ON)
- **Powered pressure probe** 0/4-20 mA between terminal 4 (power supply), 2 (negative) e 1 (positive)
Note: set IO4F to ON to activate Out4

Power supply connection:

- **Neutral wire:** terminal 9
- **Phase:** terminal 10 (100...240 Vac)
- Close terminals 15-16 to switch to the set point 2

Output connection:

- **Channel 1:** terminal 7 and 8 (burner on – off)
- **Channel 2:** terminal 11 and 12 (servomotor opens)
- **Channel 3:** terminal 13 and 14 (servomotor closes)

SETPOINT AND HYSTERESIS CONFIGURATION (SP, AL1, HAL1 parameters)

Push the  button to enter into the setpoint configuration:

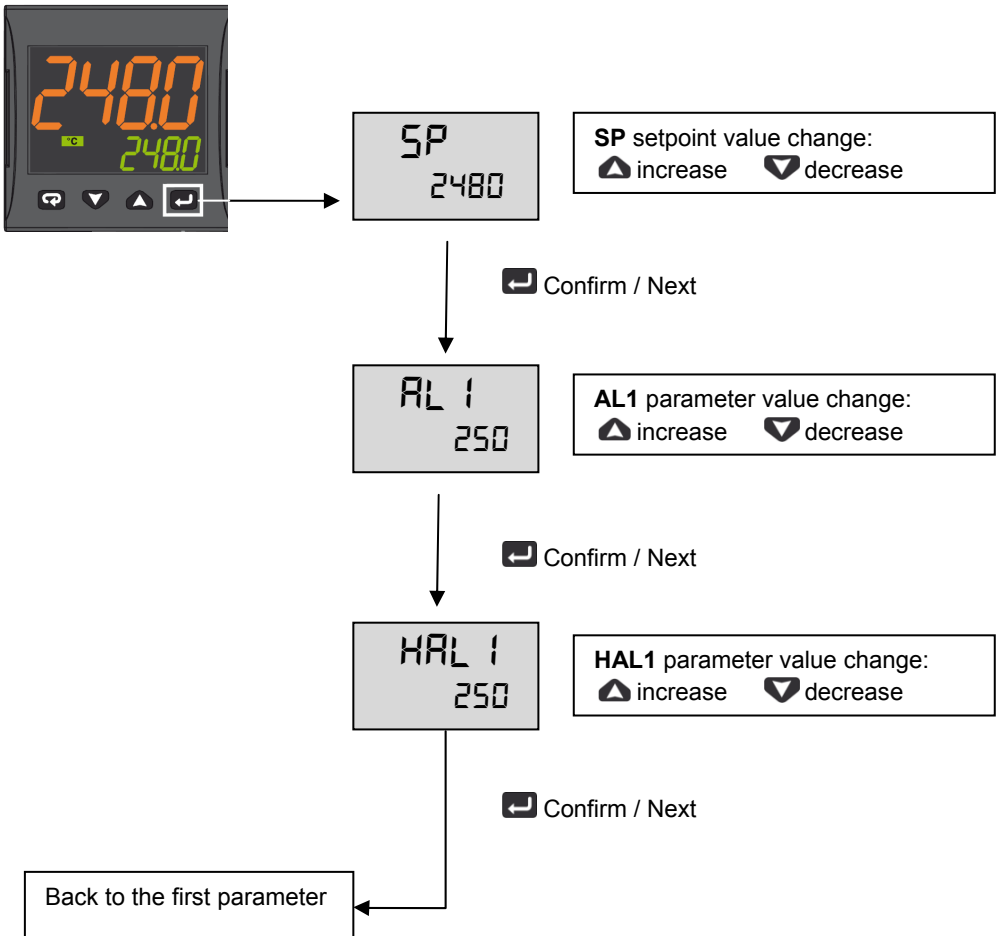

To return to normal mode, press the  key for 3 seconds or wait the 10s timeout

Operation example

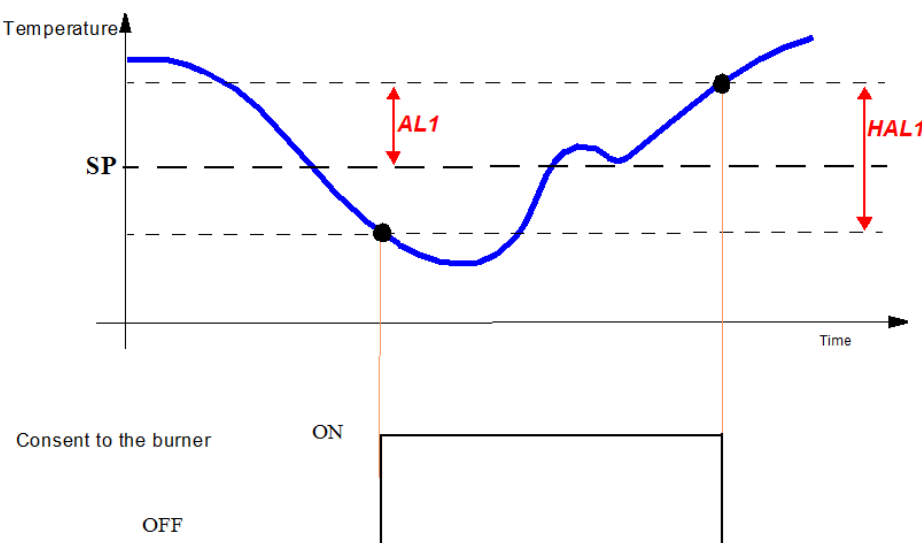

LIMITED ACCESS LEVEL

Proceed as follows to change some parameters that are not visible in standard user mode:

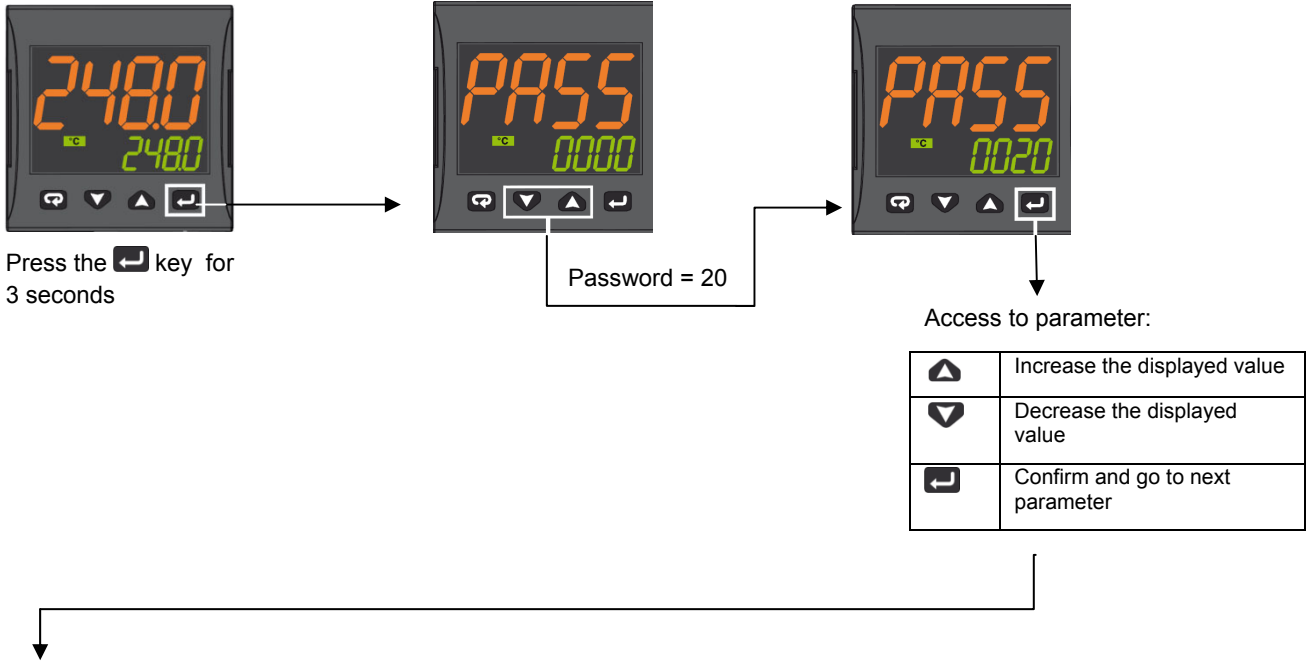

Param	Description	Values	Default
SEnS	Input type	Pt1 = RTD Pt100 Pt10 = RTD Pt1000 0.20 = 0..20mA 4.20 = 4..20mA Pressure probe 0.10 = 0..10V 2.10 = 2..10V crAL= Thermocouple K	Depends on the probe
SP	Set point 1	SPLL ... SPLH	See page 7
AL1	AL1 threshold	AL1L... AL1H (E.U.)	
HAL1	AL1 hysteresis	1... 9999 (E.U.)	
Pb	Proportional band	1... 9999 (E.U.)	
ti	Integral time	0 (oFF) ... 9999 (s)	
td	Derivative time	0 (oFF) ... 9999 (s)	
Str.t	Servomotor stroke time	5...1000 seconds	
db.S	Servomotor dead band	0...100%	
SPLL	Minimum set point value	-1999 ... SPLH	
SPHL	Maximum set point value	SPLL ... 9999	
dp	Decimal point position	0... 3	
SP 2	Set point 2	SPLL...SPLH	60
A.SP	Selection of the active set point	"SP" ... "nSP"	SP

To exit the parameter setting procedure press the [confirm] key (for 3 s) or wait until the timeout expiration (about 30 seconds)

Probe parameters configuration MODULATORE ASCON KM3

Parameter Group	inP				AL1				rEG				SP			
	Sens	dp	SSC	FSc	unit	IO4.F (**)	AL1 (***)	HAL1 (***)	Pb (***)	ti (***)	td (***)	Str.t	db.S	SPLL	SPHL	SP (***)
Probes		Dec Point	Scale Min	Scale Max			Off	On	p	i	d	servo time s	Band Mo.	SP Min	SP Max	Set point
Pt1000 (130°C max)	Pt10	1			°C	on	5	10	10	350	1	*	5	30	95	80
Pt1000 (350°C max)	PT10	1			°C	on	10	10	10	350	1	*	5	0	350	80
Pt100 (130°C max)	PT1	1			°C	on	5	10	10	350	1	*	5	0	95	80
Pt100 (350°C max)	Pt1	1			°C	on	10	10	10	350	1	*	5	0	350	80
Pt100 (0÷100°C 4÷20mA)	4.20	1	0	100		on	5	10	10	350	1	*	5	0	95	80
Thermocouple K (1200°C max)	crAL	0			°C	on	20	25	10	350	1	*	5	0	1200	80
Thermocouple J (1000°C max)	J	0			°C	on	20	25	10	350	1	*	5	0	1000	80
4-20mA / 0-1,6bar Pressure probe	4.20	0	0	160		on	20	20	5	120	1	*	5	0	160	100
4-20mA / 0-10bar Pressure probe	4.20	0	0	1000		on	50	50	5	120	1	*	5	0	1000	600
4-20mA / 0-16bar Pressure probe	4.20	0	0	1600		on	80	80	5	120	1	*	5	0	1600	600
4-20mA / 0-25bar Pressure probe	4.20	0	0	2500		on	125	125	5	120	1	*	5	0	2500	600
4-20mA / 0-40bar Pressure probe	4.20	0	0	4000		on	200	200	5	120	1	*	5	0	4000	600
QBE2002 / 0-25bar Pressure probe	0.10	0	0	2500		0n	125	125	5	120	1	*	5	0	2500	600

Note:

(*) Str.t - Servomotor stroke time

SQL33; STM30; SQM10; SQM40; SQM50; SQM54 = 30 (Seconds)

STA12B3.41; SQN30.251; SQN72.4A4A20 = 12 (Seconds)

() Out 4 ... on Display led °4 must be switched on, otherwise change the io4.F parameter value from "on" to "out4", confirm the value, quit the configuration mode then change again the io4.F parameter value from "out4" to "on".**







(***) Factory settings. These values must be adapted to machine conditions

N.B. For pressure probe, SP, SPHL, SPLL parameters values are expressed in Kpa (1 bar = 100 Kpa).

CONFIGURATION









How to access configuration level

The configuration parameters are collected in various groups. Every group defines all parameters related with a specific function (e.g.: control, alarms, output functions).

1. Push the  button for more than 5 seconds. The upper display will show PASS while the lower display will show 0.
2. Using  and  buttons set the programmed password.
According to the entered password, it is possible to see a part of the parameters listed in the "configuration parameters" section.
 - a. Enter "30" as password to view all the configuration parameters
 - b. Enter "20" as password to view the parameters of the "limited access level". At this point, only the parameters with attribute **Liv = A** or **Liv = O** will be editable.
 - c. Leave the password blank to edit "user level" parameters, that are identified by attribute **Liv = O**
3. Push the  button. If the password is correct the display will show the acronym of the first parameter group preceded by the symbol: . In other words the upper display will show:  inP (group of the **Input parameters**).

The instrument is in configuration mode. To press  for more than 5 seconds, the instrument will return to the "standard display".

Keyboard functions during parameter changing:

	Operator Mode
	When the upper display is showing a group and the lower display is blank, this key allows to enter in the selected group. When the upper display is showing a parameter and the lower display is showing its value, this key allows to store the selected value for the current parameter and access the next parameter within the same group.
	Allows to increase the value of the selected parameter.
	Allows to decrease the value of the selected parameter.
	Short presses allow you to exit the current group of parameters and select a new group. A long press terminates the configuration procedure (the instrument returns to the normal display).
 + 	These two keys allow to return to the previous group. Proceed as follows: Push the  button and maintaining the pressure, then push the  ; release both the buttons.

Configuration Parameters

inP GROUP - input configuration					
Liv	N°	Param	Description	Values	Default
A	1	SEnS	Input type	Pt1 = RTD Pt100 Pt10 = RTD Pt1000 0.20 = 0..20mA 4.20 = 4..20mA Pressure probe 0.10 = 0..10V 2.10 = 2..10V crAL= Thermocouple K	Depends on the probe
A	2	dp	Decimal point position	0... 3	See page 7
A	3	SSc	Initial scale read-out for linear inputs (available only if SEnS parameter is not equal to Pt1, Pt10, crAL values)	-1999... 9999	0
C	4	FSc	Full scale read-out for linear input inputs (available only if SEnS parameter is not equal to Pt1, Pt10, crAL values)	-1999... 9999	Depends on the probe
C	5	unit	Unit of measure (present only in the case of temperature probe)	°C/°F	°C
C	6	Fil	Digital filter on the measured value	0 (= OFF)... 20.0 s	1.0
C	7	inE	Selection of the Sensor Out of Range type that will enable the safety output value	or = Over range ou = Under range our = over e under range	or

C	8	oPE	Safety output value	-100... 100	0
C	9	io4.F	I/O4 function selection	on = Out4 will be ever ON (used as a transmitter power supply) ,out4 = Uscita 4 (Used as digital output 4), dG2c = Digital input 2 for contact closure, dG2U = Digital input 2 driven by 12... 24 VDC	on
C	10	diF1	Digital input 1 function	oFF = Not used, 1 = Alarm reset, 2 = Alarm acknowledge (ACK), 3 = Hold of the measured value, 4 = Stand by mode, 5 = Manual mode, 6 = HEAt with SP1 and Cool with SP2, 7 = Timer RUN/Hold/Reset, 8 = Timer Run, 9 = Timer Reset, 10 = Timer Run/Hold, 11 = Timer Run/Reset, 12 = Timer Run/Reset with lock, 13 = Program Start, 14 = Program Reset, 15 = Program Hold, 16 = Program Run/Hold, 17 = Program Run/Reset, 18 = Sequential SP selection, 19 = SP1 - SP2 selection, 20 = SP1... SP4 binary selection, 21 = Digital inputs in parallel	19
C	12	di.A	Digital Inputs Action (DI2 only if configured)	0 = DI1 direct action, DI2 direct action 1 = DI1 reverse action, DI2 direct action 2 = DI1 direct action, DI2 reverse action 3 = DI1 reverse action, DI2 reverse action	0

Out GROUP- Output parameters

Liv	N°	Param	Description	Values	Default
C	14	o1F	Out 1 function	AL = Alarm output	AL
C	15	o1AL	Initial scale value of the analog retransmission	-1999 ... Ao1H	1
C	18	o1Ac	Out 1 action	dir = Direct action rEU = Reverse action dir.r = Direct with reversed LED ReU.r = Reverse with reversed LED	rEU.r
C	19	o2F	Out 2 function	H.rEG = Heating output	H.rEG
C	21	o2Ac	Out 2 action	dir = Direct action rEU = Reverse action dir.r = Direct with reversed LED ReU.r = Reverse with reversed LED	dir
C	22	o3F	Out 3 function	H.rEG = Heating output	H.rEG
C	24	o3Ac	Out 3 action	dir = Direct action rEU = Reverse action dir.r = Direct with reversed LED ReU.r = Reverse with reversed LED	dir

AL1 GROUP - Alarm 1 parameters

Liv	N°	Param	Descrizione	Values	Default
C	28	AL1t	Tipo allarme AL1	nonE = Alarm not used LoAb = Absolute low alarm HiAb = Absolute high alarm LHAo = Windows alarm in alarm outside the windows LHAI = Windows alarm in alarm inside the	HidE

				windows SE.br = Sensor Break LodE = Deviation low alarm (relative) HidE = Deviation high alarm (relative) LHdo = Relative band alarm in alarm out of the band LHdi = Relative band alarm in alarm inside the band	
C	29	Ab1	Alarm 1 function	0... 15 +1 = Not active at power up +2 = Latched alarm (manual reset) +4 = Acknowledgeable alarm +8 = Relative alarm not active at set point change	0
C	30	AL1L	-- For High and low alarms, it is the low limit of the AL1 threshold; -- For band alarm, it is low alarm threshold	-1999... AL1H (E.U.)	-199.9
C	31	AL1H	-- For High and low alarms, it is the high limit of the AL1 threshold; -- For band alarm, it is high alarm threshold	AL1L... 9999 (E.U.)	999.9
O	32	AL1	AL1 threshold	AL1L... AL1H (E.U.)	See page 7
O	33	HAL1	AL1 hysteresis	1... 9999 (E.U.)	See page 7
C	34	AL1d	AL1 delay	0 (oFF)... 9999 (s)	oFF
C	35	AL1o	Alarm 1 enabling during Stand-by mode and out of range conditions	0 = Alarm 1 disabled during Stand by and out of range 1 = Alarm 1 enabled in stand by mode 2 = Alarm 1 enabled in out of range condition 3 = Alarm 1 enabled in stand by mode and in overrange condition	1

GRUPPO AL2 - parametri allarme 2

Liv	N°	Param	Description	Values	Default
C	36	AL2t	Alarm 2 type	nonE = Alarm not used LoAb = Absolute low alarm HiAb = Absolute high alarm LHAo = Windows alarm in alarm outside the windows LHAI = Windows alarm in alarm inside the windows SE.br = Sensor Break LodE = Deviation low alarm (relative) HidE = Deviation high alarm (relative) LHdo = Relative band alarm in alarm out of the band LHdi = Relative band alarm in alarm inside the band	SE.br
C	37	Ab2	Alarm 2 function	0... 15 +1 = Not active at power up +2 = Latched alarm (manual reset) +4 = Acknowledgeable alarm +8 = Relative alarm not active at set point change	0
C	42	AL2d	AL2 hysteresis	0 (oFF)... 9999 (s)	oFF
C	43	AL2o	Alarm 2 enabling during Stand-by mode and out of range conditions	0 = Alarm 2 disabled during Stand by and out of range 1 = Alarm 2 enabled in stand by mode 2 = Alarm 2 enabled in out of range condition 3 = Alarm 2 enabled in stand by mode and in overrange condition	0

AL3 Group - alarm 3 parameters					
Liv	N°	Param	Description	Values	Default
	44	AL3t	Alarm 3 type	nonE = Alarm not used LoAb = Absolute low alarm HiAb = Absolute high alarm LHAo = Windows alarm in alarm outside the windows LHAI = Windows alarm in alarm inside the windows SE.br = Sensor Break LodE = Deviation low alarm (relative) HidE = Deviation high alarm (relative) LHdo = Relative band alarm in alarm out of the band LHdi = Relative band alarm in alarm inside the band	nonE

LbA Group - Loop break alarm					
Liv	N°	Param	Descrizione	Values	Default
C	52	LbAt	LBA time	Da 0 (oFF) a 9999 (s)	oFF

rEG Group - Control parameters					
Liv	N°	Param	Description	Values	Default
C	56	cont	Control type	Pid = PID (heat and/or) On.FA = ON/OFF asymmetric hysteresis On.FS = ON/OFF symmetric hysteresis nr = Heat/Cool ON/OFF control with neutral zone 3Pt = Servomotor control (available only when Output 2 and Output 3 have been ordered as "M")	3pt
C	57	Auto	Autotuning selection	-4 = Oscillating auto-tune with automatic restart at power up and after all point change -3 = Oscillating auto-tune with manual start -2 = Oscillating -tune with auto-matic start at the first power up only -1 = Oscillating auto-tune with auto-matic restart at every power up 0 = Not used 1 = Fast auto tuning with automatic restart at every power up 2 = Fast auto-tune with automatic start the first power up only 3 = FAST auto-tune with manual start 4 = FAST auto-tune with automatic restart at power up and after set point change 5 = Evo-tune with automatic restart at every power up 6 = Evo-tune with automatic start the first power up only 7 = Evo-tune with manual start 8 = Evo-tune with automatic restart at power up and after a set point change	7
C	58	tunE	Manual start of the Autotuning	oFF = Not active on = Active	oFF

C	59	SELF	Self tuning enabling	no = The instrument does not perform the self-tuning YES = The instrument is performing the self-tuning	No
A	62	Pb	Proportional band	1... 9999 (E.U.)	See page 7
A	63	ti	Integral time	0 (oFF) ... 9999 (s)	See page 7
A	64	td	Derivative time	0 (oFF) ... 9999 (s)	See page 7
C	65	Fuoc	Fuzzy overshoot control	0.00... 2.00	1
C	69	rS	Manual reset (Integral pre-load)	-100.0... +100.0 (%)	0.0
A	70	Str.t	Servomotor stroke time	5...1000 seconds	See page 7
A	71	db.S	Servomotor dead band	0...100%	5
C	72	od	Delay at power up	0.00 (oFF) ... 99.59 (hh.mm)	oFF

SP Group - Set point parameters

Liv	N°	Param	Description	Values	Default
C	76	nSP	Number of used set points	1... 4	2
A	77	SPLL	Minimum set point value	-1999 ... SPHL	See page 7
A	78	SPHL	Maximum set point value	SPLL ... 9999	See page 7
O	79	SP	Set point 1	SPLL ... SPLH	See page 7
C	80	SP 2	Set point 2	SPLL ... SPLH	60
	83	A.SP	Selection of the active set point	"SP" ... "nSP"	SP
C	84	SP.rt	Remote set point type	RSP = The value coming from serial link is used as remote set point trin = The value will be added to the local set point selected by A.SP and the sum becomes the operative set point PErc = The value will be scaled on the input range and this value will be used as remote SP	trin
C	85	SPLr	Local/remote set point selection	Loc = Local rEn = Remote	Loc
C	86	SP.u	Rate of rise for POSITIVE set point change (ramp UP)	0.01... 99.99 (inF) Eng. units per minute	inF
C	87	SP.d	Rate of rise for NEGATIVE set point change (ramp DOWN)	0.01... 99.99 (inF) Eng. units per minute	inF

PAn Group - Operator HMI

Liv	N°	Param	Description	Values	Default
C	118	PAS2	Level 2 password (limited access level)	oFF (Level 2 not protected by password) 1... 200	20
C	119	PAS3	Level 3 password (complete configuration level)	3... 300	30
C	120	PAS4	Password livello (livello configurazione a codice)	201... 400	300
C	121	uSrb	button function during RUN TIME	nonE = No function tunE = Auto-tune/self-tune enabling. A single press (longer than 1 second) starts the auto-tune oPLo = Manual mode. The first pressure puts the instrument in manual mode (OPLO) while a second one puts the instrument in Auto mode	tunE

				AAC = Alarm reset ASi = Alarm acknowledge chSP = Sequential set point selection St.by = Stand by mode. The first press puts the instrument in stand by mode while a second one puts the instrument in Auto mode. Str.t = Timer run/hold/reset P.run = Program run P.rES = Program reset P.r.H.r = Program run/hold/reset	
C	122	diSP	Display management	Spo = Operative set point	SPO
C	123	di.cL	Display colour	0 = The display colour is used to show the actual deviation (PV - SP) 1 = Display red (fix) 2 = Display green (fix) 3 = Display orange (fix)	2
	125	diS.t	Display Timeout	-- oFF (display always ON) -- 0.1... 99.59 (mm.ss)	oFF
C	126	fiLd	Filter on the displayed value	-- oFF (filter disabled) -- From 0.0 (oFF) to 20.0 (E.U.)	oFF
C	128	dSPu	Instrument status at power ON	AS.Pr = Starts in the same way it was prior to the power down Auto = Starts in Auto mode oP.0 = Starts in manual mode with a power output equal to zero St.bY = Starts in stand-by mode	Auto
C	129	oPr.E	Operative modes enabling	ALL = All modes will be selectable by the next parameter Au.oP = Auto and manual (OPLO) mode only will be selectable by the next parameter Au.Sb = Auto and Stand-by modes only will be selectable by the next parameter	ALL
C	130	oPEr	Operative mode selection	If oPr.E = ALL: - Auto = Auto mode - oPLo = Manual mode - St.bY = Stand by mode If oPr.E = Au.oP: - Auto = Auto mode - oPLo = Manual mode If oPr.E = Au.Sb: - Auto = Auto mode - St.bY = Stand by mode	Auto

SEr Group - Serial link parameter

Liv	N°	Param	Description	Values	Default
C	131	Add	Instrument address	-- oFF -- 1... 254	1
C	132	bAud	baud rate	1200 = 1200 baud 2400 = 2400 baud 9600 = 9600 baud 19.2 = 19200 baud 38.4 = 38400 baud	9600
C	133	trSP	Selection of the value to be retransmitted (Master)	nonE = Retransmission not used (the instrument is a slave) rSP = The instrument becomes a Master and retransmits the operative set point PErc = The instrument become a Master and it retransmits the power output	nonE

con Group - Consumption parameters					
Liv	N°	Param	Description	Values	Default
C	134	Co.tY	Count type	<p>oFF = Not used</p> <p>1 = Instantaneous power (kW)</p> <p>2 = Power consumption (kW/h)</p> <p>3 = Energy used during program execution. This measure starts from zero when a program runs end stops at the end of the program. A new program execution will reset the value</p> <p>4 = Total worked days: number of hours the instrument is turned ON divided by 24.</p> <p>5 = Total worked hours: number of hours the instrument is turned ON.</p> <p>6 = Total worked days with threshold: number of hours the instrument is turned ON divided by 24, the controller is forced in stand-by when Co.ty value reaches the threshold set in [137] h.Job.</p> <p>7 = Total worked hours with threshold: number of hours the instrument is turned ON, the controller is forced in stand-by when Co.ty value reaches the threshold set in [137] h.Job.</p> <p>8 = Totalizer of control relay worked days: number of hours the control relay has been in ON condition, divided by 24.</p> <p>9 = Totalizer of control relay worked hours: number of hours the control relay has been in ON condition.</p> <p>10 = Totalizer of control relay worked days with threshold: number of hours the control relay has been in ON condition divided by 24, the controller is forced in stand-by when Co.ty value reaches the threshold set in [137] h.Job.</p> <p>11 = Totalizer of control relay worked hours with threshold: number of hours the control relay has been in ON condition, the controller is forced in stand-by when Co.ty value reaches the threshold set in [137] h.Job.</p>	oFF
C	138	t.Job	Worked time (not resettable)	0... 9999 days	0

cAL Group - User calibration group					
Liv	N°	Param	Description	Values	Default
C	139	AL.P	Adjust Low Point	From -1999 to (AH.P - 10) in engineering units	0
C	140	AL.o	Adjust Low Offset	-300... +300 (E.U.)	0
C	141	AH.P	Adjust High Point	From (AL.P + 10) to 9999 engineering units	999.9
C	142	AH.o	Adjust High Offset	-300... +300	0

OPERATIVE MODES

When the instrument is powered, it starts immediately to work according to the parameters values loaded in its memory. The instrument behaviour and its performance are governed by the value of the stored parameters.

At power ON the instrument can start in one of the following mode depending on its configuration:

Automatic Mode In Automatic mode the instrument drives automatically the control output according to the parameter value set and the set point/measured value.

Manual Mode (OPLO): In Manual mode the the upper display shows the measured value while the lower display shows the power output The lower display shows the power output [preceded by H (for heating) or C (for cooling)], MAN is lit and the instrument allows you to set manually the control output power. No Automatic action will be made.





Stand by Mode (St.bY): In stand-by mode the instrument operates as an indicator. It will show on the upper display the measured value and on the lower display the set point alternately to the "St.bY" messages and forces the control outputs to zero.

We define all the above described conditions as "Standard Display".

As we have seen, it is always possible to modify the value assigned to a parameter independently from the operative modes selected.









AUTOMATIC MODE

Keyboard function when the instrument is in Auto mode:

Modo Operatore	
	Allows entry into parameter modification procedures
	Allows you to start the "Direct set point modification" function (see below).
	Allows you to display the "additional informations" (see below).
	Performs the action programmed by [121] uSrb ( button function during RUN TIME) parameter

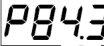
Additional information





This instrument is able to show you some additional informations that can help you to manage your system. The additional informations are related to how the instrument is programmed, hence in many cases, only part of this information is available.

1. When the instrument is showing the "standard display" push  button. The lower display will show H or c followed by a number. This value is the current power output applied to the process. The H show you that the action is a Heating action while the "c" show you that the action is a Cooling action
2. Push  button again. When the programmer is running the lower display will show the segment currently performed and the Event status as shown below:
 where the first character can be r for a ramp or S for a soak, the next digit show the number of the segment (e.g. S3 means Soak number 3) and the twoless significant digits (LSD) show you the status of the two event (the LSD is the Event 2)..
3. Push  button again. When the programmer is running the lower display will show the theoretical remaining time to the end of the program preceded by a "P" letter:

4. Push  button again. When the wattmeter function is running the lower display will show U followed by the measured energy..
5. Push  button. When the "Worked time count" is running the lower display will show "d" for days or "h" for hours followed by the measured time.
6. Push  button. The instrument returns to the "standard display".



Note: The additional information visualization is subject to a time out. If no button is pressed for more than 10 second the instrument comes automatically back to the Standard display..

Direct set point modification

This function allows to modify rapidly the set point value selected by [83] A.SP (selection of the active Set point) or to the set point of the segment group (of the programmer) currently in progress.

1. Push  button. The upper display shows the acronym of the selected set point (e.g. SP2) and the lower display will show its value.
2. By  and  buttons, assign to this parameter the desired value
3. Do not push any button for more than 5 second or push the  button. In both cases the instrument memorize the new value and come back to the “standard display”.

Manual mode

This operative mode allows you to deactivate automatic control and manually program the percentage power output to the process. When the instrument is in manual mode, the upper display shows the measured value while the lower display shows the power output [preceded by H (for heating action) or C (for cooling action)] The MAN LED is lit. When manual control is selected, the instrument will start to operate with the same power output as the last one supplied by automatic mode and can be modified using the  and  buttons.

In case of ON/OFF control, 0% corresponds to the deactivated output while any value different from 0 corresponds to the activated output. As in the case of visualization, the programmable values range from H100 (100% output power with reverse action) to C100 (100% output power with direct action).

Notes:

- During manual mode, the alarms are operative.
- If you set manual modes during program execution, the program will be frozen and it will restart when the instrument will come back to Auto mode.
- If you set manual modes during self-tune execution, the self- tune function will be aborted.
- During manual mode, all functions not related with the control (wattmeter, independent timer, “worked time”, etc) continue to operate normally..

STAND-BY MODE

This operative mode also deactivates the automatic control but forces the control output to zero. In this mode the instrument operates as an indicator. When the instrument is in stand by mode the upper display will show the measured value while the lower display will show alternately the set point and the message “St.bY”.

Notes:

- During stand by mode, the relative alarms are disabled while the absolute alarms are operative or not according to the ALx0 (Alarm x enabling during Stand-by mode) parameter setting.
- If you set stand by mode during program execution, the program will be aborted.
- If you set stand by mode during self-tune execution, the self- tune function will be aborted.
- During stand by mode, all functions not related with the control (wattmeter, independent timer, “worked time”, etc) continue to operate normally.
- When the instrument is swapped from stand by to auto modes, the instrument will start automatically the alarm masking, the soft start functions and the auto-tune (if programmed).

AUTOTUNE (EVOTUNE)

Evotune is a fast and fully automatic procedure that can be started in any condition, regardless the deviation from SP. The controller selects automatically the best tune method and computes the optimum PID parameters. To activate Evotune press  button for 3 seconds.

ERROR MESSAGES

The upper display shows the OVER-RANGE and UNDERRANGE conditions with the following indications:

Over-range: 

Under-range 

The sensor break will be signalled as an out of range: - - - -

Note: When an over-range or an under-range is detected, the alarms operate as in presence of the maximum or the minimum measurable value respectively.

To check the out of span Error condition, proceed as follows:

1. Check the input signal source and the connecting line.
2. Make sure that the input signal is in accordance with the instrument configuration. Otherwise, modify the input configuration.
3. If no error is detected, send the instrument to your supplier to be checked.

List of possible errors

ErAT Fast Auto-tune cannot start. The measure value is too close to the set point. Push the button in order to delete the error message.

ouLd Overload on the out 4. The messages shows that a short circuit is present on the Out 4 when it is used as output or as a transmitter power supply. When the short circuit disappears the output restart to operate..

NoAt Auto-tune not finished within 12 hours.

ErEP Possible problem of the instrument memory. The messages disappears automatically. When the error continues, send the instrument to your supplier.





RonE Possible problem of the firmware memory. When this error is detected, send the instrument to your supplier.

Errt Possible problem of the calibration memory. When this error is detected, send the instrument to your supplier.

FACTORY RESET

Sometime, e.g. when you re-configure an instrument previously used for other works or from other people or when you have made too many errors during configuration and you decided to re-configure the instrument, it is possible to restore the factory configuration. This action allows to put the instrument in a defined condition (the same it was at the first power ON).

The default data are those typical values loaded in the instrument prior to ship it from factory. To load the factory default parameter set, proceed as follows:

1. Press the  button for more than 5 seconds. The upper display will show PASS while the lower display shows 0;
2. Using  and  buttons set the value -481;
3. Push  button;
4. The instrument will turn OFF all LEDs for a few seconds, then the upper display will show dFLt (default) and then all LEDs are turned ON for 2 seconds. At this point the instrument restarts as for a new power ON.

The procedure is complete.

Note: The complete list of the default parameters is available in Chapter "Configuration".

RWF55.5X & RWF55.6X



User manual

DEVICE INSTALLATION

Fixing system

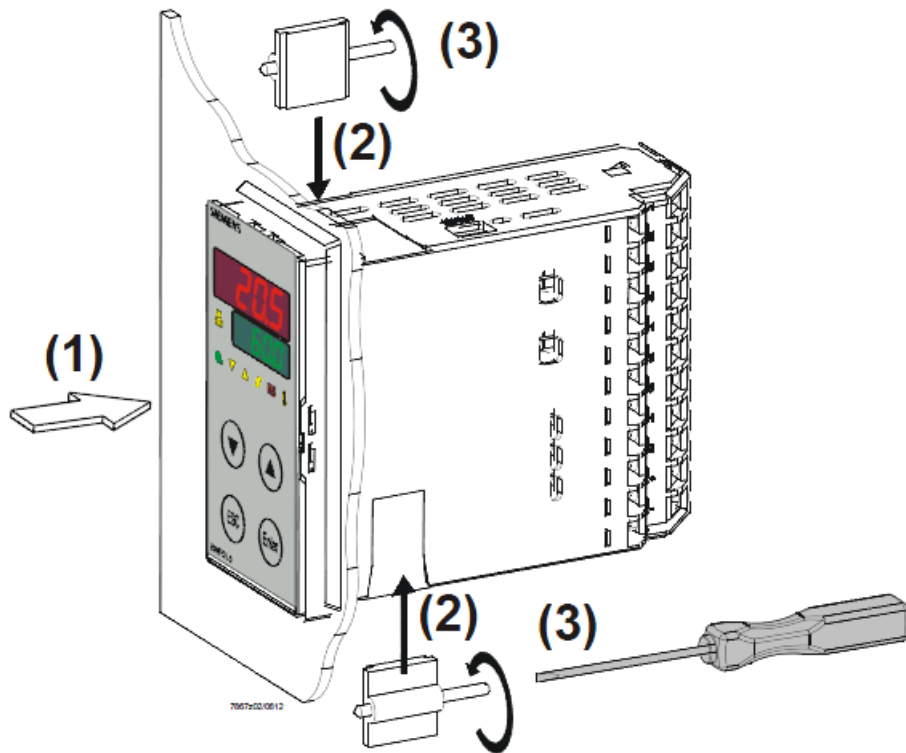

Drilling dimensions:

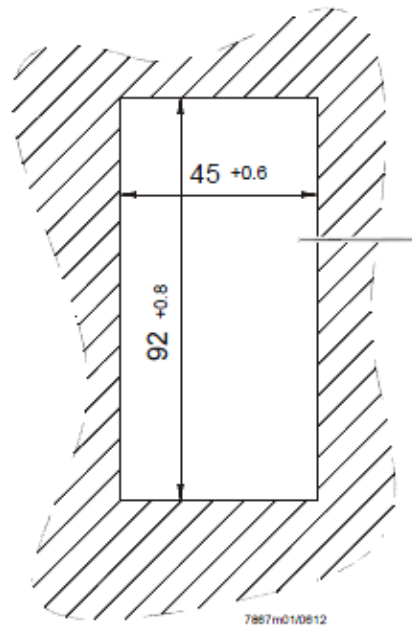

FRONT PANEL

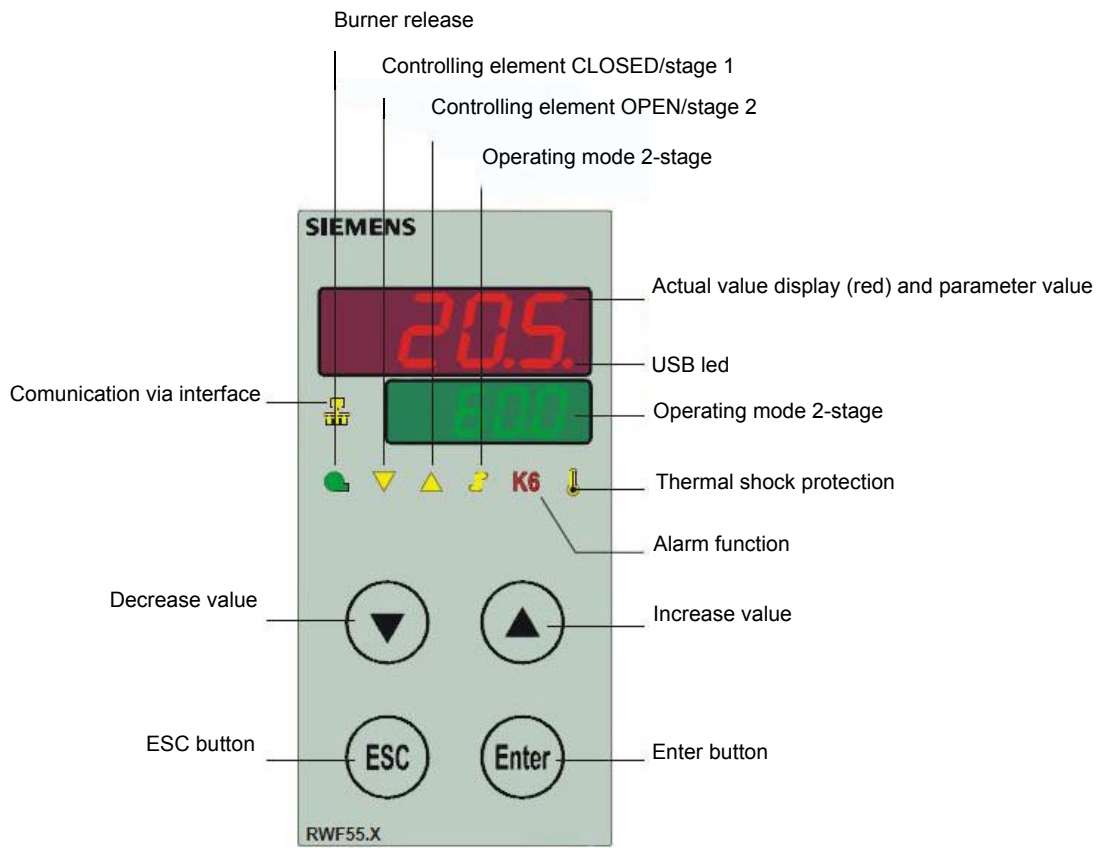

NAVIGATION MENU

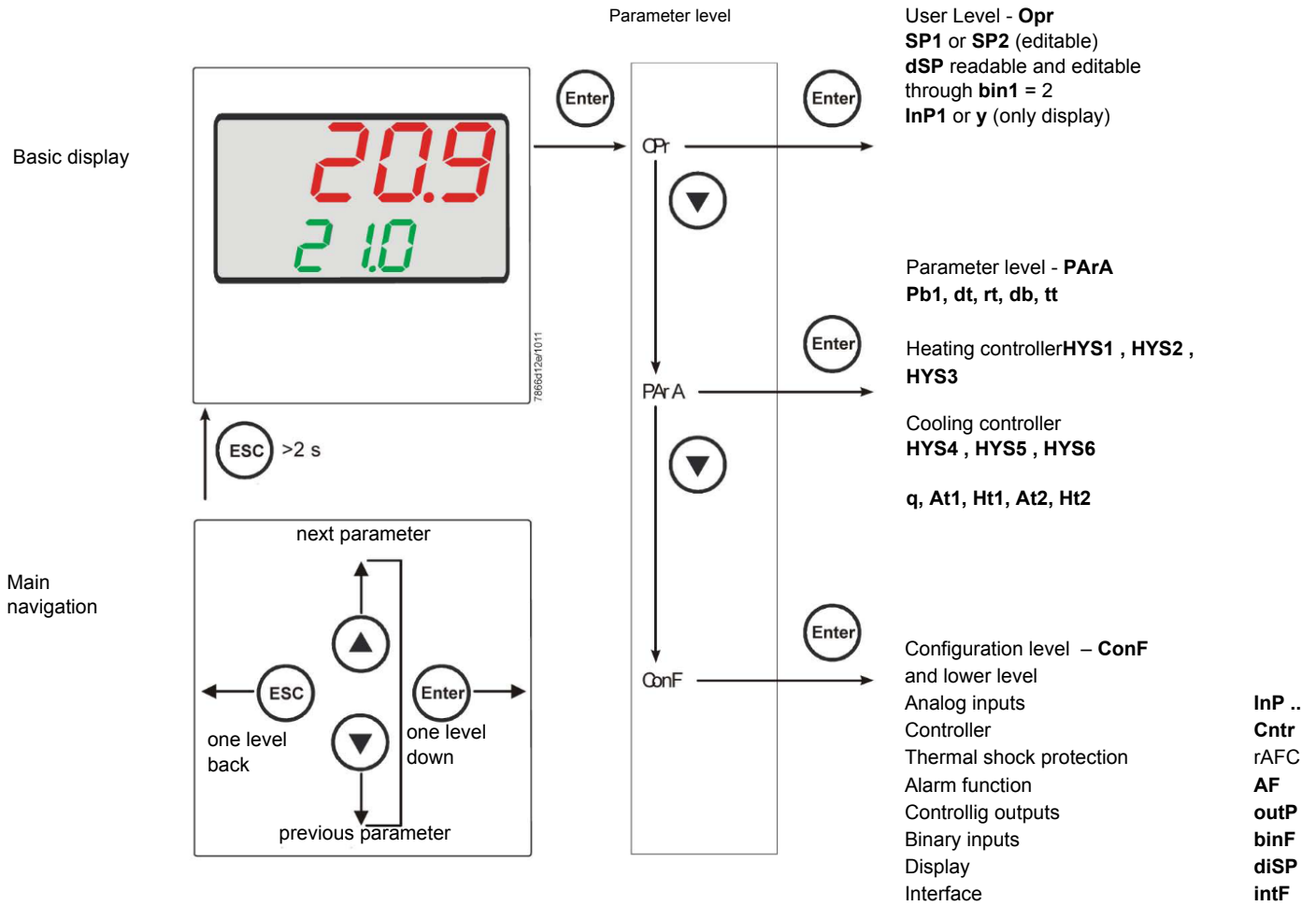

RWF55 is preset good for 90% of applications. However, you can set or edit parameters as follow:

Set-point: set or modification:

When the burner is in stand-by, (safety loop open, that is terminals 3-4/T1-T2 on the 7 pole plug open) push the Enter button: on the lower display (green) Opr appears; push Enter again and in the same display SP1 appears. Push Enter again and the lower display (green SP1) flashes. Using the up and down arrows change the set-point on the upper display (red). Push Enter to confirm and push ESC more times to get the home position.

PID parameters set and modifications (PARA):

Push **Enter** button, on the green display **Opr** appears; using the **down arrow**, scroll until group **PARA** is reached and push **Enter**.
On the green display **Pb1** e appears and on the red one the set parameter. Push in sequence the **down or up** arrow the menu is scrolled.
Push **Enter** to select and the **arrows** to choose the desired value. **Enter** to confirm

Parameter	Display	Range	Factory setting	Remarks
Proportional band	Pb1	1... 9999 digit	10	Typical value for temperature
Derivative action	dt	0... 9999 sec.	80	Typical value for temperature
Integral action	rt	0... 9999 sec.	350	Typical value for temperature T
Dead band (*)	db	0... 999,9 digit	1	Typical value
Servocontrol running time	tt	10... 3000 sec.	15	Set servocontrol running time
Switch-on differential (*)	HYS1	0,0... -1999 digit	-5	Value under setpoint below which the burner switches back on (1N-1P closes)
Switch-off differential 2° stage (*)	HYS2	0,0 ... HYS3	3	(enable only with parameter bin1 = 4)
Upper switch-off differential (*)	HYS3	0,0... 9999 digit	5	Value over setpoint above which the burner switches off (1N-1P opens)
Switch-on differential on cooling controller (*)	HYS4	0,0... 9999 digit	5	Do not used (enable only with parameter CACT = 0)
Switch-off differential 2° stage on cooling controller (*)	HYS5	HYS6...0,0 digit	5	Do not used (enable only with parameter CACT = 0 and parameter bin1 =0)
Upper switch-off differential on cooling controller (*)	HYS6	0,0... -1999 digit	5	Do not used (enable only with parameter CACT = 0)
Delay modulation	q	0,0... 999,9 digit	0	Do not alter
T Outside temperature Curve point 1 (*)	At1	-40 ...120 digit	-10	First point of external temperature for climatic curve
Boiler temperature Curve point 1 (*)	Ht1	SPL...SPH	60	Set-point temperature for the external temperature 1
TT Outside temperature Curve point 2 (*)	At2	-40 ...120 digit	20	Second point of external temperature for climatic curve
Boiler temperature Curve point 2 (*)	Ht2	SPL...SPH	50	Set-point temperature for the external temperature 2

(*) Parameters affected by setting of decimal place (**ConF** > **dISP** parameter **dECP**)

Setting the kind of sensor to be connected to the device:

Push the **Enter** button: on the lower display (green) **Opr** appears. Using the **up and down arrows** find **ConF**. Push **Enter** to confirm. Now on the green display the group **InP** appears. Push **Enter** and **InP1** is displayed. Enter to confirm. You are inside **InP1**; the green display shows **Sen1 (sensor type)**, while the red display shows the chosen sensor code Push **Enter** to enter the **Sen1** parameter, then choose the desired sensor using the **arrows**. Push **Enter** to confirm and **ESC** to escape.

Once selected the sensor, you can modify all the other parameters using **up and down arrows** according to the tables here below :

ConF > InP > InP1

Parameter	Value	Description
SEn1 type of sensor for analog input 1	1	Pt100 3 wire
	2	Pt100 2 wire
	3	Pt1000 3 wire
	4	Pt1000 2 wire
	5	Ni1000 3 wire
	6	Ni1000 2 wire
	7	0 ÷ 135 ohm
	8	Cu-CuNi T
	9	Fe-CuNi J
	10	NiCr-Ni K
	11	NiCrSi-NiSi N
	12	Pt10Rh-Pt S
	13	Pt13Rh-Pt R
	14	Pt30Rh-Pt6Rh B
	15	0 ÷ 20mA
	16	4 ÷ 20mA
	17	0 ÷ 10V
	18	0 ÷ 5V
	19	1 ÷ 5V
OFF1 Sensor offset	-1999..0.. +9999	Correction value measured by the sensor
SCL1 scale low level	-1999..0.. +9999	minimum scale value(for input ohm, mA, V)
SCH1 scale high level	-1999.. 100 .. +9999	maximum scale value(for input ohm, mA, V)
dF1 digital filter	0... 0,6 ...100	Is used to adapt the digital 2nd order input filter (time in s; 0 s = filter off)
Unit temperature unit	1 2	1 = degrees Celsius 2 = degrees Fahrenheit

(**bold** = factory settings)

ConF > InP > InP2

Input 2 : this input can be used to specify an external setpoint or carry out setpoint shifting

Parameter	Value	Description
FnC2	0	0= no function
	1	1= external setpoint (display SPE)
	2	2 =setpoint shifting (display dSP)
	3	3 = angular positioning feedback
SEn2 sensor type input 2	1	0 ÷ 20mA
	2	4 ÷ 20mA
	3	0 ÷ 10V
	4	0 ÷ 5V
	5	1 ÷ 5V
	1	0 ÷ 20mA
OFF2 Sensor offset	-1999..0.. +9999	Correction value measured by the sensor
SCL2 scale low level	-1999..0.. +9999	minimum scale value(for input ohm, mA, V)
SCH2 scale high level	-1999.. 100 .. +9999	maximum scale value(for input ohm, mA, V)
dF2 digital filter	0... 2 ...100	Is used to adapt the digital 2nd order input filter (time in s; 0 s = filter off)

(**bold** = factory settings)

ConF > InP > InP3

Input 3: this input is used to acquire the outside temperature

Parameter	Value	Description
SEn3 sensor type input 3 sensor type input 2	0	0 =
	1	1 = wire
	2	2 = wire
OFF3 Sensor offset	-1999..0.. +9999	Correction value measured by the sensor
dF3 digital filter	0... 1278 ...1500	Is used to adapt the digital 2nd order input filter (time in s; 0 s = filter off)

(**bold** = factory settings)

ConF > Cntr

Here, the type of controller, operating action, setpoint limits and presettings for self-optimization are selected

Parameter	Value	Description
CtYP controller type	1 2	1 = 3-position controller (open-stop-close) 2 = continuative action controller (0 ÷ 10V or 4 ÷ 20mA)
CACT control action	1 0	1 = heating controller 0 = cooling controller
SPL least value of the set-point range	-1999..0..+9999	minimum set-point scale
SPH maximum value of the set-point range	-1999..100..+999	maximum set-point scale
Self-optimization	0 1	0 = Free 1 = Locked Self-optimization can only be disabled or enabled via the ACS411 setup program. Self-optimization is also disabled when the parameter level is locked
oLLo set-point limitation start, operation limit low	-1999.... +9999	lower working range limit
oLHi set-point limitation end, operation limit high	-1999.... +9999	upper working range limit

(bold = factory settings)

ConF > rAFC

Activation boiler shock termic protetion:

RWF55.. can activate the thermal shock protection only on sites where the set-point is lower than 250°C and according to rAL parameter

Parameter	Value	Description
FnCT type of contol	0 1 2	choose type of range degrees/time 0 = deactivated 1 = Kelvin degrees/minute 2 = Kelvin degrees/hour
rASL ramp rate	0,0 ... 999,9	Slope of thermal shock protection (only with functions 1 and 2)
toLP tolerance band ramp	2 x (HYS1) = 10...9999	width of tolerance band (in K) about the set-point 0 = tolerance band inactive
rAL ramp limit	0...250	Ramp limit. When this value is lower than the temperature set-point, the RWF controls the output increasing the temp set point step by step according to rASL. If this is over the temp set point, the control is performed in cooling

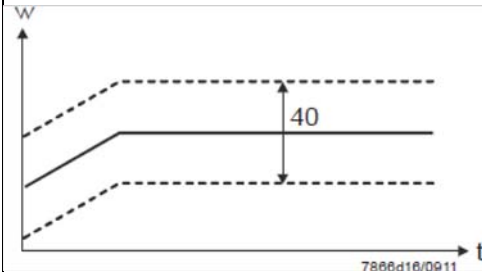

(bold = factory settings)

Alarm function AF

The alarm function can be used to monitor the analog inputs. If the limit value is exceeded, multifunctional relay K6 (terminals **6N** and **6P**) is activated (depending on the switching characteristic)

The alarm function can have different switching functions (Ik1 to Ik8) and can be set to a deviation from the active setpoint or to a fixed limit value

Limit value **AL** relative to setpoint (x)

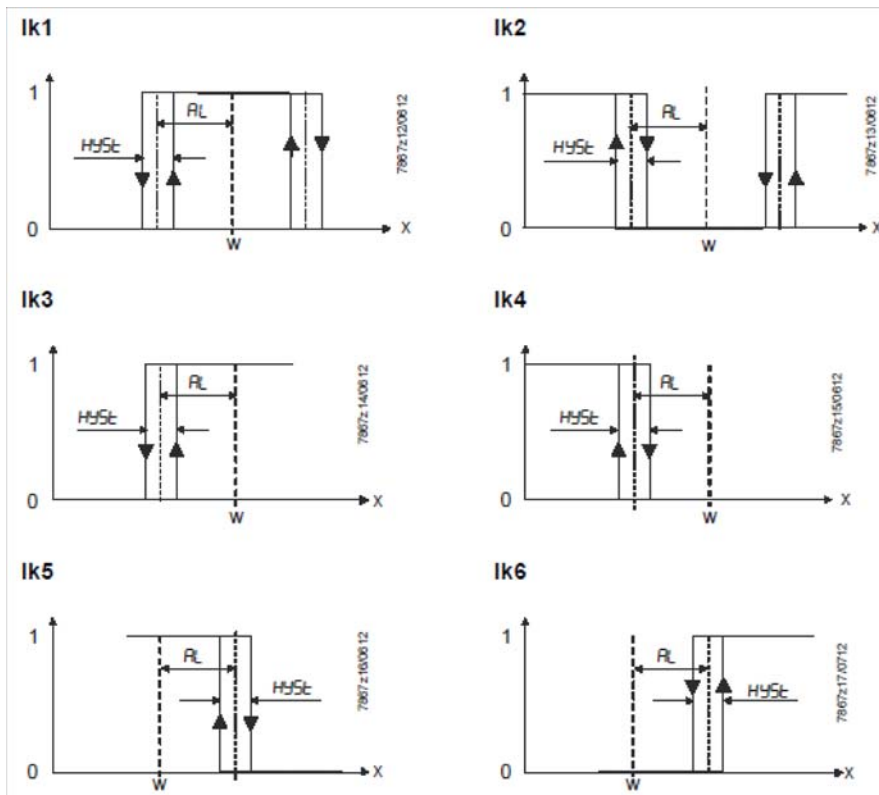

Fixed limit value **AL**

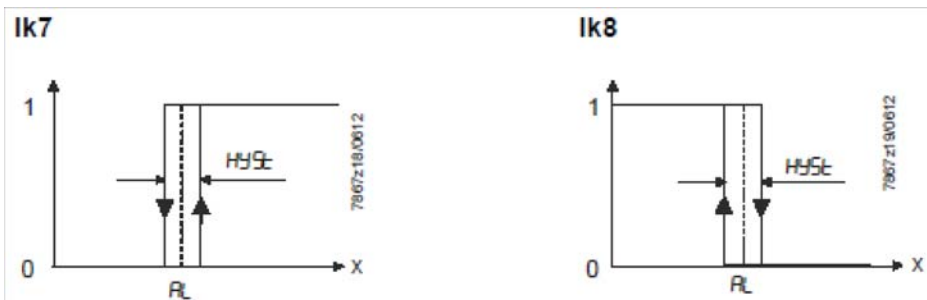

ConF > AF

Parameter	Value	Description
FnCt type of control	0 1 2 3 4 5 6 7 8 9 10 11 12	0 = Without function lk1 = monitored input InP1 lk2 = monitored input InP1 lk3 = monitored input InP1 lk4 = monitored input InP1 lk5 = monitored input InP1 lk6 = monitored input InP1 lk7 = monitored input InP1 lk8 = monitored input InP1 lk7 = monitored input InP2 lk8 = monitored input InP2 lk7 = monitored input InP3 lk8 = monitored input InP3
Alarm value AL	-1999 ... 0 1999	Limit value or deviation from setpoint to be monitored (see alarm functions lk1 to lk8 : limit value AL) Limit value range for lk1 and lk20 ...9999
HySt switching differential	0... 1... 9999	Switching differential for limit value AL
ACrA response by out of range	0 1	Switched-off ON Switching state in the case of measuring range overshoot or undershoot (Out of Range)

(**bold** = factory settings)

ConF > OutP

For fuel-air ratio control purposes, the RWF55 has the binary outputs K2, K3 (terminals KQ, K2, K3) and the analog output (terminals A+, A-). The burner is released via relay K1 (terminals 1N, 1P).

The binary outputs of the RWF55 offer no setting choices

The RWF55 has an analog output.

The analog output offers the following setting choices:

Parameter	Value	Description
FnCt type of control	1 2 3 4	1 = analog input 1 doubling with possibility to convert 2 = analog input 2 doubling with possibility to convert 3 = analog input 3 doubling with possibility to convert 4 = Controller's angular positioning is delivered (modulating controller)
SiGn type of output signal	0 1 2	physical output signal (terminals A+, A-) 0 = 0÷20mA 1 = 4÷20mA 2 = 0÷10V DC
rOut value when out of input range	0 ...101	signal (in percent) when measurement range is crossed
oPnt zero point	-1999... 0 ...+9999	A value range of the output variable is assigned to a physical output signal (for FnCt = 1, 2, 3)
End end point	-1999... 100 ...+9999	A value range of the output variable is assigned to a physical output signal (for FnCt = 1, 2, 3)

(**bold** = factory settings)

ConF > binF

This setting decides on the use of the binary inputs **D1**, **D2**, **DG**

b

Parameter	Value	Description
bin1 binary input 1 (terminals DG – D1)	0 1 2 3	0 = without function 1 = set-point changeover (SP1 / SP2) 2 = Iset-point shift (Opr > dSP parameter = value of set-point modify) 3 = input alarm
bin2 binary input 2 (terminals DG – D2)	4	changeover of operating mode DG-D2 open = modulating operation DG-D2 close = 2 stage operation

(**bold** = factory settings)

ConF > dISP

.Both displays can be customized to suit your needs by configuring the displayed value, decimal, time out and blocking

Parameter	Value	Description
diSU upper display (red)	0 1 2 3 4 6 7	Display value for upper display: 0 = display power-off 1 = analog input 1 (InP1) value 2 = analog input 2 (InP2) value 3 = analog input 3 (InP3) value 4 = controller's angular positioning 6 = set-point values 7 = end value with thermal shock protection
diSL lower display (green)	0 1 2 3 4 6 7	Display value for lower display: 0 = display power-off 1 = analog input 2 (InP2) value 2 = analog input 2 (InP2) value 3 = analog input 2 (InP2) value 4 = controller's angular positioning 6 = set-point values 7 = end value with thermal shock protection
tout timeout	0.. 180 ..250	time (s) on completion of which the controller returns automatically to the basic display, if no button is pressed
dECP decimal point	0 1 2	0 = no decimal place 1 = one decimal place 2 = two decimal place
CodE level lockout	0 1 2 3	0 = no lockout 1 = configuration level lockout (ConF) 2 = parameter and configuration level lockout (PARa & ConF) 3 = keyboard lockout

(**bold** = factory settings)

ConF > IntF

The controller can be integrated into a data network using an optional RS-485 (terminals R+ and R-) interface or an optional Profibus DP interface(only model **RWF55.6x** terminals C1-C2-C3-C4)

Parameter	Value	Description
bdrt	0	0 = 4800 baud
baudrate	1	1 = 9600 baud
	2	2 = 19200 baud
	3	3 = 38400 baud
Adr	0..	Address in the data network
Device address Modbus	1..	
	254	
dP	0.. 125	only with RWF55.6x
Device address Profibus		
dt	0..	0 = switched-off
Remote detection time	30 ..	
	7200s	

(**bold** = factory settings)

Manual control :

In order to manual change the burner load, while firing keep pushing the **ESC** button for more than 5 s; on the lower green display **Hand** appears.

using the **UP** and **DOWN** arrows, the load varies.

Keep pushing the **ESC** button for getting the normal operation again.

NB: every time the device shuts the burner down (start led switched off - contact 1N-1P open), the manual control is not active.

Device self-setting (auto-tuning):

If the burner in the steady state does not respond properly to heat generator requests, you can activate the Device's self-setting function, which recalculates PID values for its operation, deciding which are most suitable for the specific kind of request



Follow the below instructions:

push the **UP** and **DOWN** arrows for more than 5 s; on the green lower display **tUnE** appears. Now the device pushes the burner to increase and decrease its output. During this time, the device calculates **PID** parameters (**Pb1**, **dt** and **rt**). After the calculations, the **tUnE** is automatically deactivated and the device has already stored them.

In order to stop the Auto-tuning function while it works, push again the **UP** and **DOWN** arrows for more than 5 s. The calculated **PID** parameters can be manually modified following the previously described instructions.

Display of software version :

The software version is shown by pushing Enter + UP arrow on the upper display.



Weather-compensated setpoint shifting (climatic regulation):

The RWF55 can be configured so that weather-compensated setpoint shifting is activated when an LG-Ni1000 outside sensor or a Pt1000 is connected (see parameter **InP3**).

To take into account the time response of a building, weather-compensated setpoint shifting uses the attenuated outside temperature rather than the current outside temperature.

The minimum and maximum setpoints can be set using the lower setpoint limit **SPL** and the upper setpoint limit **SPH** of the menu **Crtr**.

The system also prevents the lower working range limit **oLLo** and upper working range limit **oLHi** from exceeding/dropping below the system temperature limits.

The heating curve describes the relationship between the boiler temperature setpoint and the outside temperature. It is defined by 2 curve points. For 2 outside temperatures, the user defines the boiler temperature setpoint that is required in each case. The heating curve for the weather-compensated setpoint is calculated on this basis. The effective boiler temperature setpoint is limited by the upper setpoint limit **SPH** and the lower setpoint limit **SPL**.

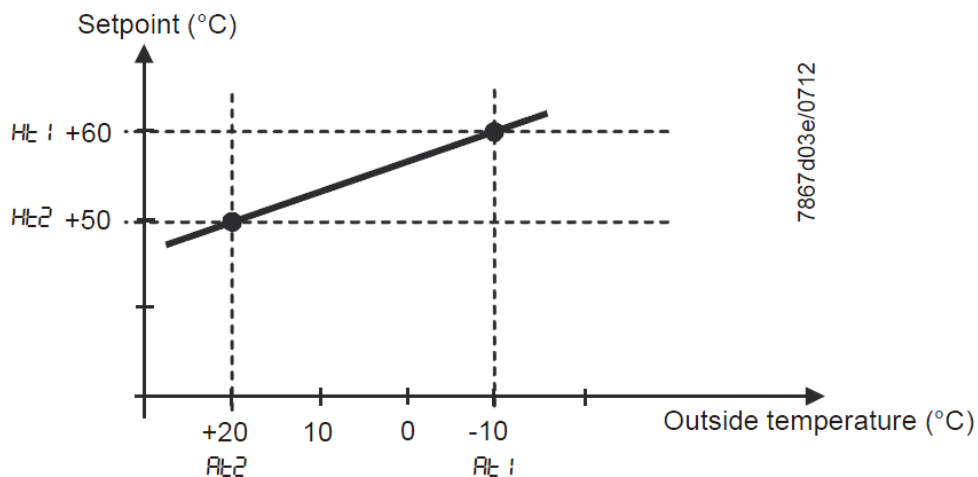

For setting climatic regulation function set:

PArA > parameters **At1**, **Ht1**, **At2**, **Ht2**

ConF > **InP** > **InP3** parameters **SEn3**, **FnC3** = 1 (Weather-compensated setpoint).

Modbus interface

The tables that follow in this chapter specify the addresses of the readable and writable words that the customer is able to access. The customer may read and/or write the values using SCADA programs, PLCs, or similar.

The entries under Access have the following meanings:

R/O Read Only, value can only be read

R/W Read/Write, value can be read and written

The number of characters specified under Data type in the case of character strings includes the final \0.

Char10 means that the text is up to 9 characters long. The final \0 character is then added to this

User level

Address	Access	Data type	Signal reference	Parameter
0x0000	R/O	Float	X1	Analog input InP1
0x0002	R/O	Float	X2	Analog input InP2
0x0004	R/O	Float	X3	Analog input InP2
0x0006	R/O	Float	WR	Actual setpoint
0x0008	R/W	Float	SP1	Setpoint 1
0x000A	R/W	Float	SP2 (= dSP)	Setpoint 2
0x1035	R/O	Float	---	Analog input InP3 (unfiltered)
0x1043	R/O	Float	---	Actual angular positioning
0x1058	R/O	Word	B1	Burner alarm

Parameter level

Address	Access	Data type	Signal reference	Parameter
0x3000	R/W	Float	Pb1	Proportional range 1
0x3004	R/W	Float	dt	Derivative action time
0x3006	R/W	Float	rt	Integral action time
0x300C	R/W	Float	db	Dead band
0x3012	R/W	Word	tt	Controlling element running time
0x3016	R/W	Float	HYS1	Switch-on threshold
0x3018	R/W	Float	HYS2	Switch-off threshold down
0x301A	R/W	Float	HYS3	Switch-off threshold up
0x301C	R/W	Float	HYS4	Switch-on threshold (cooling)
0x301E	R/W	Float	HYS5	Switch-off threshold down (cooling)
0x3020	R/W	Float	HYS6	Switch-off threshold up (cooling)
0x3022	R/W	Float	q	Reaction threshold
0x3080	R/W	Float	At1	Outside temperature 1
0x3082	R/W	Float	Ht2	Boiler temperature 1
0x3084	R/W	Float	At2	Outside temperature 2
0x3086	R/W	Float	Ht2	Boiler temperature 2

Configuration level

Address	Access	Data type	Signal reference	Parameter
0x3426	R/W	Float	SCL1	Start of display input 1
0x3428	R/W	Float	SCH1	End of display input 1
0x3432	R/W	Float	SCL2	Start value input 2
0x3434	R/W	Float	SCH2	End value input 2
0x3486	R/W	Float	SPL	Start of setpoint limitation
0x3488	R/W	Float	SPH	End of setpoint limitation
0x342A	R/W	Float	OFFS1	Offset input E1
0x3436	R/W	Float	OFFS2	Offset input E2
0x343A	R/W	Float	OFFS3	Offset input E3
0x1063	R/W	Word	FnCt	Ramp function
0x1065	R/W	Float	rASL	Ramp slope
0x1067	R/W	Float	toLP	Tolerance band ramp
0x1069	R/W	Float	rAL	Limit value
0x1075	R/W	Float	dtT	Remote Detection Timer
0x1077	R/W	Float	dF1	Filter constant input 1
0x1079	R/W	Float	dF2	Filter constant input 2
0x107B	R/W	Float	dF3	Filter constant input 3
0x107D	R/O	Float	oLLo	Lower working range limit
0x107F	R/O	Float	oLHi	Upper working range limit
0x106D	R/W	Word	FnCt	Alarm relay function
0x106F	R/W	Float	AL	Alarm relay limit value (limit value alarm)
0x1071	R/W	Float	HYSt	Alarm relay hysteresis

Remote operation

Address	Access	Data type	Signal reference	Parameter
0x0500	R/W	Word	REM	Activation remote operation *
0x0501	R/W	Word	rOFF	Controller OFF in remote setpoint **
0x0502	R/W	Float	rHYS1	Switch-on threshold remote
0x0504	R/W	Float	rHYS2	Switch-off threshold down remote
0x0506	R/W	Float	rHYS3	Switch-off threshold up remote
0x0508	R/W	Float	SPr	Setpoint remote
0x050A	R/W	Word	RK1	Burner release remote operation
0x050B	R/W	Word	RK2	Relay K2 remote operation
0x050C	R/W	Word	RK3	Relay K3 remote operation
0x050D	R/W	Word	RK6	Relay K6 remote operation
0x050E	R/W	Word	rStEP	Step-by-step control remote operation
0x050F	R/W	Float	rY	Angular positioning output remote operation
0x0511	R/W	Float	rHYS4	Switch-on threshold remote (cooling)
0x0513	R/W	Float	rHYS5	Switch-off threshold down remote (cooling)
0x0515	R/W	Float	rHYS6	Switch-off threshold up remote (cooling)

Legend

* = Local

** = Controller OFF

Dati dell'apparecchio

Address	Access	Data type	Signal reference	Parameter
0x8000	R/O	Char12	---	Software version
0x8006	R/O	Char14	---	VdN number

Stato dell'apparecchio

Address	Access	Data type	Signal reference	Parameter
0x0200	R/O	Word	---	Outputs and states
			Bit 0	Output 1
			Bit 1	Output 3
			Bit 2	Output 2
			Bit 3	Output 4
			Bit 8	Hysteresis limitation
			Bit 9	Control system
			Bit 10	Self-optimization
			Bit 11	Second setpoint
			Bit 12	Measuring range overshoot InP1
			Bit 13	Measuring range overshoot InP2
			Bit 14	Measuring range overshoot InP3
			Bit 15	Calibration mode
0x0201	R/O	Word	---	Binary signals and hardware detection
			Bit 0	Operation mode 2-stage
			Bit 1	Manual mode
			Bit 2	Binary input D1
			Bit 3	Binary input D2
			Bit 4	Thermostat function
			Bit 5	First controller output
			Bit 6	Second controller output
			Bit 7	Alarm relay
			Bit 13	Analog output available
			Bit 14	Interface available

Electric connections :

With 7 pins connector version

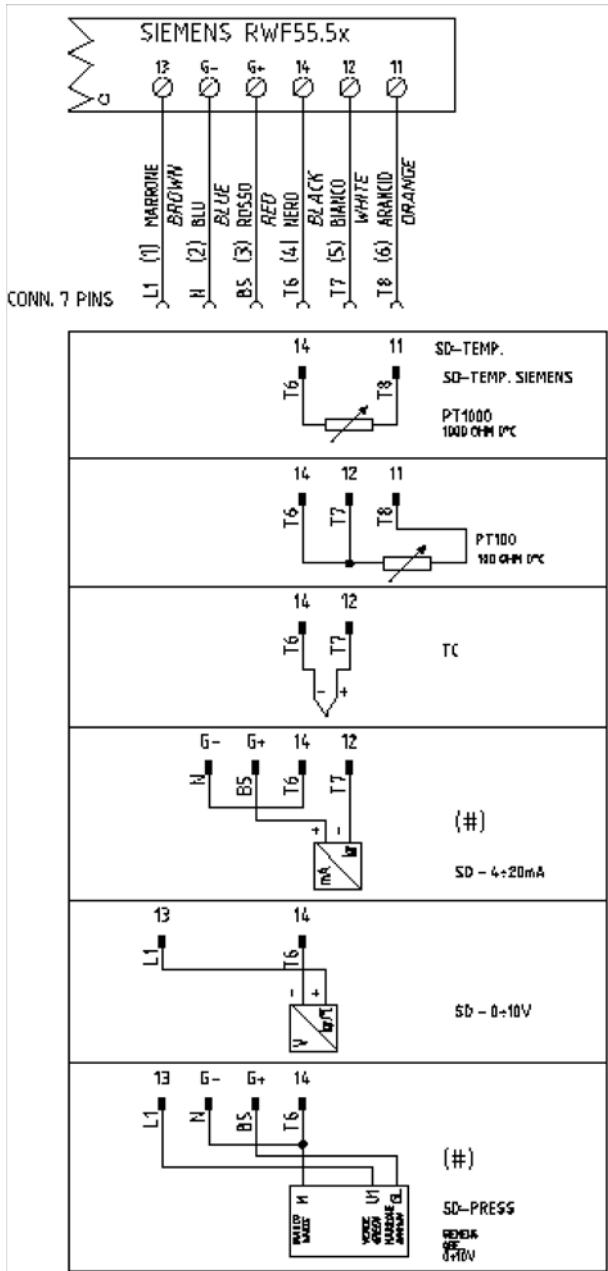

With terminals version

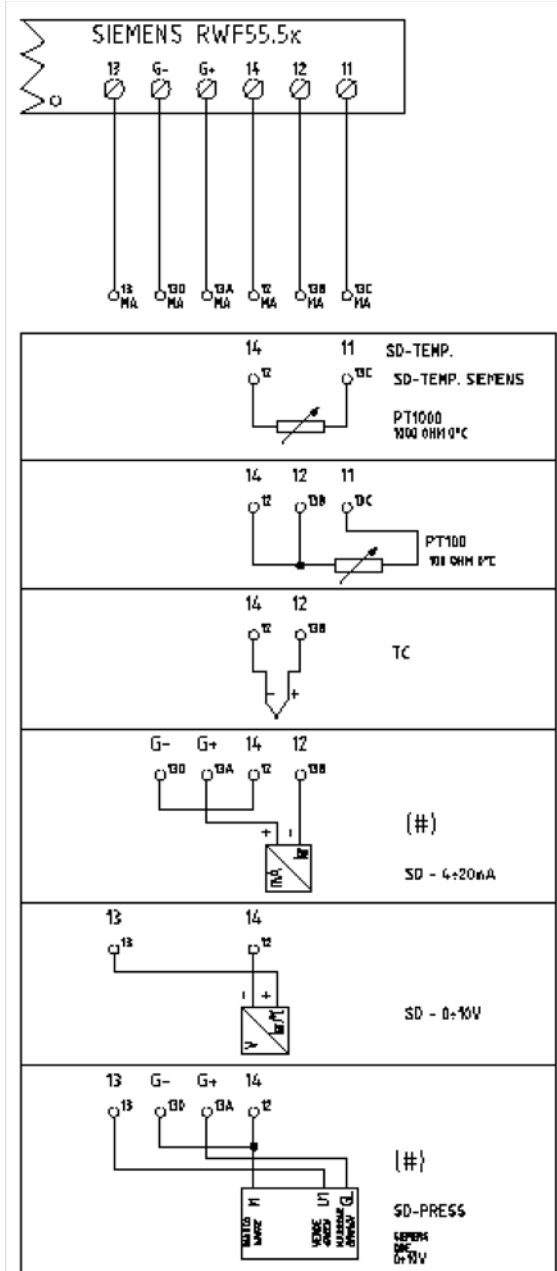

Correspondences bornes entre RWF55.5x y RWF40.0x0 Matches terminals between RWF55.5x and RWF40.0x0

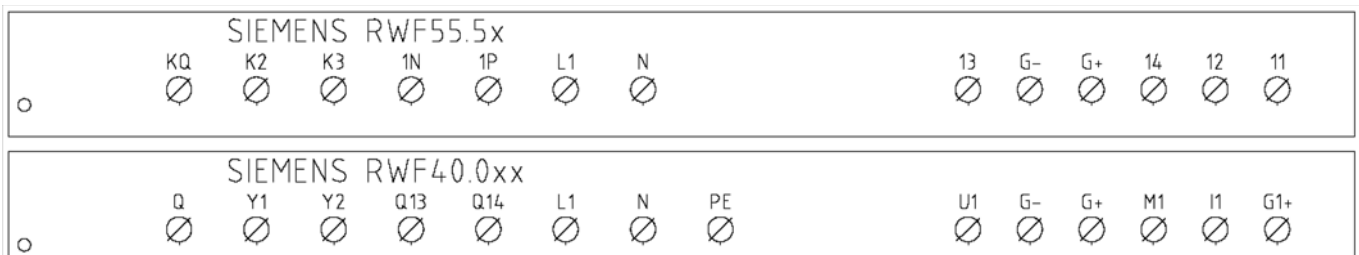

Parameters summarising for RWF55.xx :

Navigation menu	ConF					ConF			PArA						Opr
	Inp					Cntr		diSP							Opr
	Inp1														
	SEn1	OFF1	SCL	SCH	Unit	SPL	SPH	dECP	Pb. 1	dt	rt	tt	HYS1 (*)	HYS3 (*)	SP1 (*)
Siemens QAE2120...	6	0	needless	needless	1	30	95	1	10	80	350	(#)	-5	5	80 °C
Siemens QAM2120..	6	0	needless	needless	1	0	80	1	10	80	350	(#)	-2,5	2,5	40°C
Pt1000 (130°C max.)	4	0	needless	needless	1	30	95	1	10	80	350	(#)	-5	5	80°C
Pt1000 (350°C max.)	4	0	needless	needless	1	0	350	1	10	80	350	(#)	-5	10	80°C
Pt100 (130°C max.)	1	0	needless	needless	1	0	95	1	10	80	350	(#)	-5	5	80°C
Pt100 (350°C max)	1	0	needless	needless	1	0	350	1	10	80	350	(#)	-5	10	80°C
Probe4+20mA / 0+1,6bar	16	0	0	160	needless	0	160	0	5	20	80	(#)	0	20	100 kPa
Probe4+20mA / 0+3bar	16	0	0	300	needless	0	300	0	5	20	80	(#)	0	20	200 kPa
Probe 4+20mA / 0+10bar	16	0	0	1000	needless	0	1000	0	5	20	80	(#)	0	50	600 kPa
Probe 4+20mA / 0+16bar	16	0	0	1600	needless	0	1600	0	5	20	80	(#)	0	80	600 kPa
Probe 4+20mA / 0+25bar	16	0	0	2500	needless	0	2500	0	5	20	80	(#)	0	125	600 kPa
Probe 4+20mA / 0+40bar	16	0	0	4000	needless	0	4000	0	5	20	80	(#)	0	200	600 kPa
Probe 4+20mA / 0+60PSI	16	0	0	600	needless	0	600	0	5	20	80	(#)	0	30	300 (30PSI)
Probe4+20mA / 0+200PSI	16	0	0	2000	needless	0	2000	0	5	20	80	(#)	0	75	600 (60PSI)
Probe4+20mA / 0+300PSI	16	0	0	3000	needless	0	3000	0	5	20	80	(#)	0	120	600 (60PSI)
Siemens QBE2002 P4	17	0	0	400	needless	0	400	0	5	20	80	(#)	0	20	200 kPa
Siemens QBE2002 P10	17	0	0	1000	needless	0	1000	0	5	20	80	(#)	0	50	600 kPa
Siemens QBE2002 P16	17	0	0	1600	needless	0	1600	0	5	20	80	(#)	0	80	600 kPa
Siemens QBE2002 P25	17	0	0	2500	needless	0	2500	0	5	20	80	(#)	0	125	600 kPa
Siemens QBE2002 P40	17	0	0	4000	needless	0	4000	0	5	20	80	(#)	0	200	600 kPa
Signal 0+10V	17	0	needless	needless	needless	needless	needless	needless	5	20	80	(#)			
Signal 4+20mA	16	0	needless	needless	needless	needless	needless	needless	5	20	80	(#)			

NOTE:

(#) tt – servo control run time

SQL33 ; STM30; SQM10; SQM40; SQM50; SQM54 = 30 (secondi) - STA12B3.41; SQN30.251; SQN72.4A4A20 = 12 (secondi)

(*)These values are factory set - values must be set during operation at the plant based on the real working temperature/pressure value.

WARNING :

With pressure probes in bar the parameters SP1, SCH, SCL, HYS1, HYS3 must be set and displayed in kPa (kilo Pascal); 1bar = 100,000Pa = 100kPa.

With pressure probes in PSI the parameters SP1, SCH, SCL, HYS1, HYS3 must be set and displayed in PSI x10 (example: 150PSI > I display 1500).

APPENDIX: PROBES CONNECTION

To assure the utmost comfort, the control system needs reliable information, which can be obtained provided the sensors have been installed correctly. Sensors measure and transmit all variations encountered at their location.

Measurement is taken based on design features (time constant) and according to specific operating conditions. With wiring run in raceways, the sheath (or pipe) containing the wires must be plugged at the sensor's terminal board so that currents of air cannot affect the sensor's measurements.

Ambient probes (or ambient thermostats)

Installation

The sensors (or room thermostats) must be located in reference rooms in a position where they can take real temperature measurements without being affected by foreign factors.

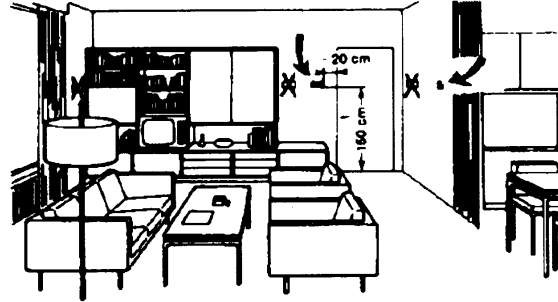
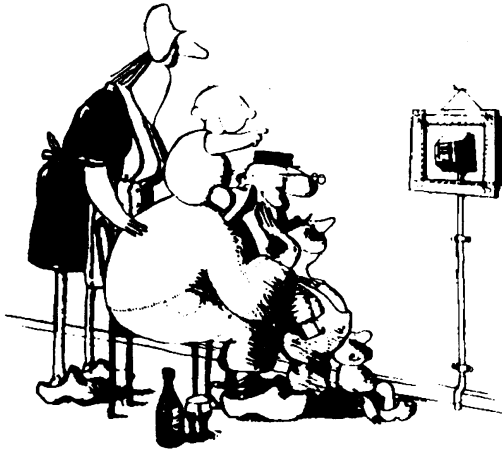

Outside probes (weather) Installation

In heating or air-conditioning systems featuring adjustment in response to outside temperature, the sensor's positioning is of paramount importance.

It's good to be admired ...even better to be effective

Heating systems: the room sensor must not be installed in rooms with heating units complete with thermostatic valves. Avoid all sources of heat foreign to the system.

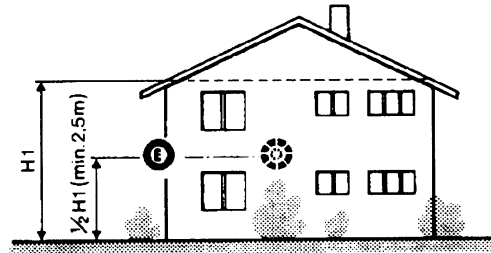
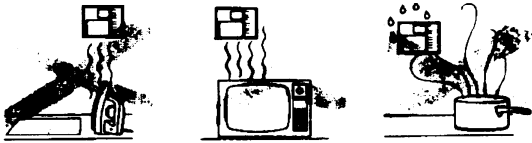

General rule: en on the outer wall of the building where the living rooms are, never on the south-facing wall or in a position where they will be affected by morning sun. If in any doubt, place them on the north or north-east façade.

Positions to be avoided

Location

On an inner wall on the other side of the room to heating units height above floor 1.5 m, at least 1.5 m away from external sources of heat (or cold).

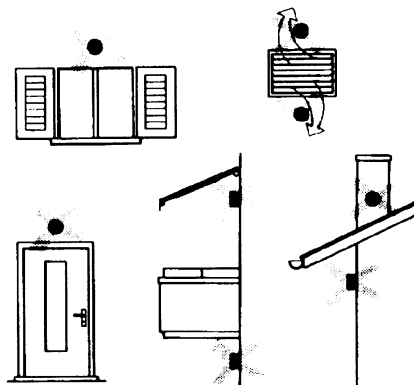
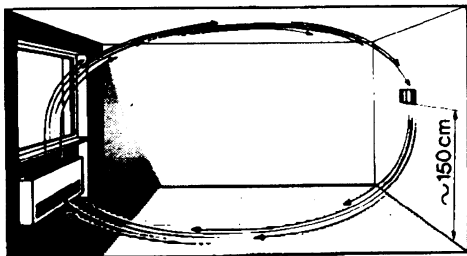

Installation position to be avoided

near shelving or alcoves and recesses, near doors or windows, inside outer walls exposed to solar radiation or currents of cold air, on inner walls with heating system pipes, domestic hot water pipes, or cooling system pipes running through them.

Avoid installing near windows, vents, outside the boiler room, on chimney breasts or where they are protected by balconies, cantilever roofs .

The sensor must not be painted (measurement error) .

Duct or pipe sensors

Installing temperature sensors

For measuring outlet air:

"after delivery fan or

"after coil to be controlled, at a distance of at least 0,5 m

For measuring room temperature:

"before return air intake fan and near room's return airintake.

For measuring saturation temperature: after mist eliminator.

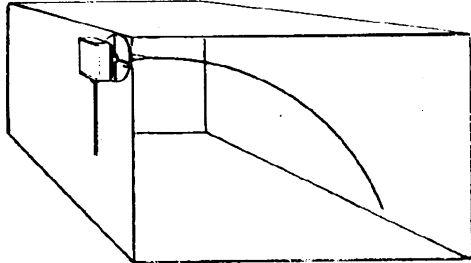

Bend 0.4m sensor by hand (never use tools) as illustrated .

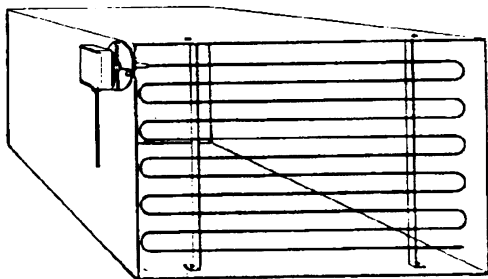

Use whole cross-section of duct, min. distance from walls 50 mm, radius of curvature 10 mm for 2m or 6m sensors

Installing combined humidity sensors

As max. humidity limit sensor on outlet (steam humidifiers) .

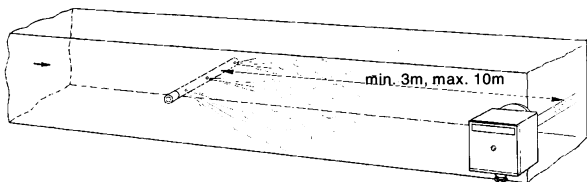

Installing pressure sensors

A - installation on ducts carrying fluids at max. temperature 80°C

B - installation on ducts at temperature over 80°C and for refrigerants

C - installation on ducts at high temperatures :

· "increase length of siphon

"place sensor at side to prevent it being hit by hot air coming from the pipe.

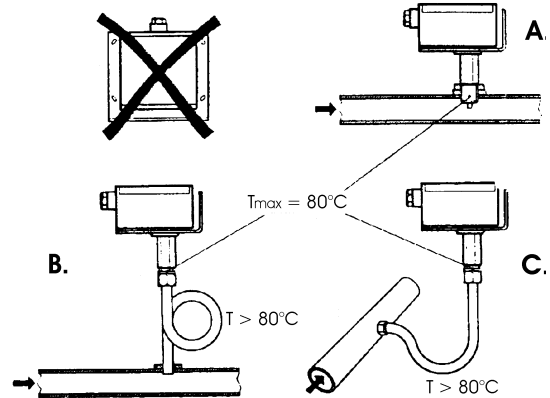

Installing differential pressure sensors for water

Installation with casing facing down not allowed.

With temperature over 80°C, siphons are needed.

To avoid damaging the sensor, you must comply with the following instructions :

when installing: make sure pressure difference is not greater than the value permitted by the sensor

when there are high static pressures, make sure you insert shutoff valves A-B-C.

Putting into operation

Start disable

1=open C1=open C

2=open A2=close B

3=open B3=close A

4= close C

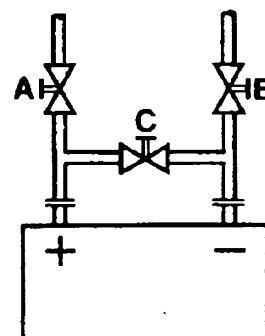

Immersion or strap-on sensors

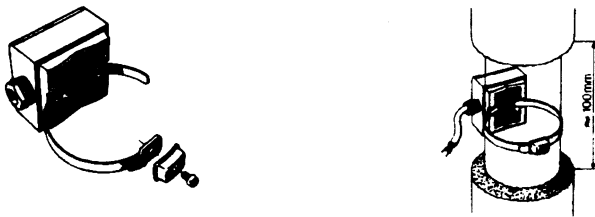
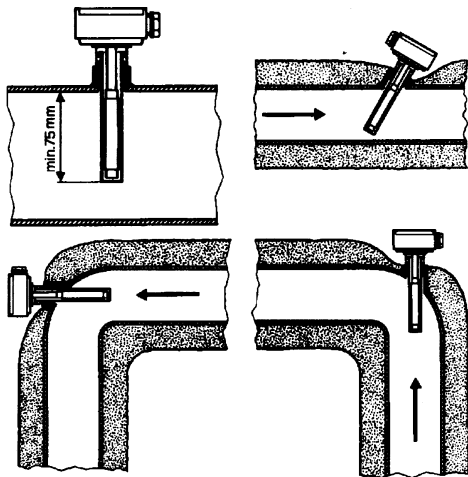

Placing the probes (QAD22.../QAE21.../QAP21.../RCA...)

With pumps on outlet

with 3 ways valves / with 4 ways valves



Panel system / burner control

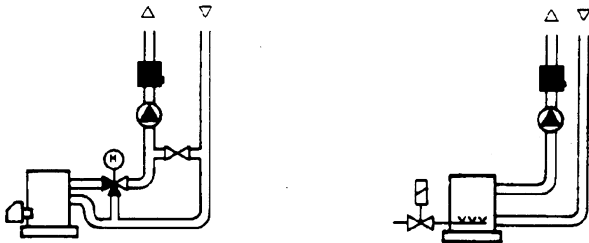

With pumps on return

with 3 ways valves / with 4 ways valves



Immersion probes installation

Sensors must be installed on the stretch of pipe in which fluid circulates all the time.

The rigid stem (sensing element doing the measuring) must be inserted by at least 75mm and must face the direction of flow.

Recommended locations: on a bend or on a straight stretch of pipe but tilted by 45° and against the flow of fluid.

Protect them to prevent water from infiltrating (dripping gates, condensation from pipes etc.) .

Installing QAD2.. strap-on sensors

Make sure fluid is circulating in the chosen location.

Eliminate insulation and paintwork (including rust inhibitor) on a min. 100mm length of pipe.

Sensors come with straps for pipes up to 100 mm in diameter .

Strap-on or immersion sensors?

QAD2.. strap-on sensors

Advantages :

- 10 sec. time constant
- Installed with system running (no plumbing work)
- Installation can be changed easily if it proves incorrect

ΠLimits:

- Suitable for pipe diameters max. 100 mm
- Can be affected by currents of air etc.

QAE2... immersion sensors

Advantages:

- Measure "mean" fluid temperature
- No external influence on measurement such as: currents of air, nearby pipes etc.

Limits:

- Time constant with sheath: 20 sec.
- Hard to change installation position if it proves incorrect

Installing differential pressure probes for air

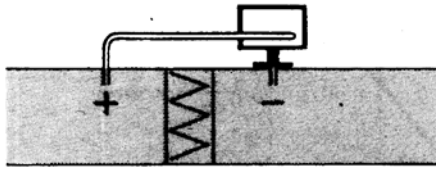

A - Control a filter (clogging)

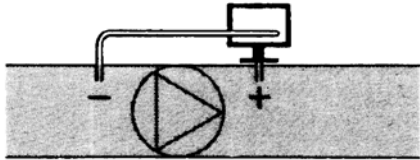

B - Control a fan (upstream/downstream)

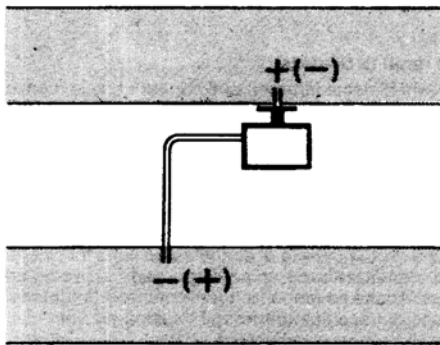

C - Measurement of difference in pressure between two ducts

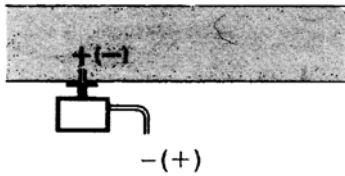

D - Measurement of difference in pressure between two rooms or of inside of duct and outside

Basic principles

Measuring static pressure (i.e. pressure exerted by air on pipe walls)

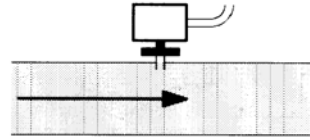

Measuring dynamic pressure

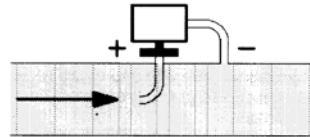

$$P_d = \frac{\gamma v^2}{2g}$$

Legend

- y Kg/m³, specific weight of air
- q m/s, air speed
- g 9.81 m/s² gravity acceleration
- P_d mm C.A., dynamic pressure

Measuring total pressure

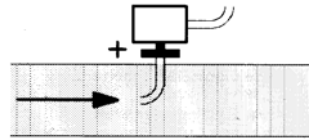

Note: Specifications and data subject to change. Errors and omissions excepted.

KM3 Modulator

USER MANUAL

MOUNTING

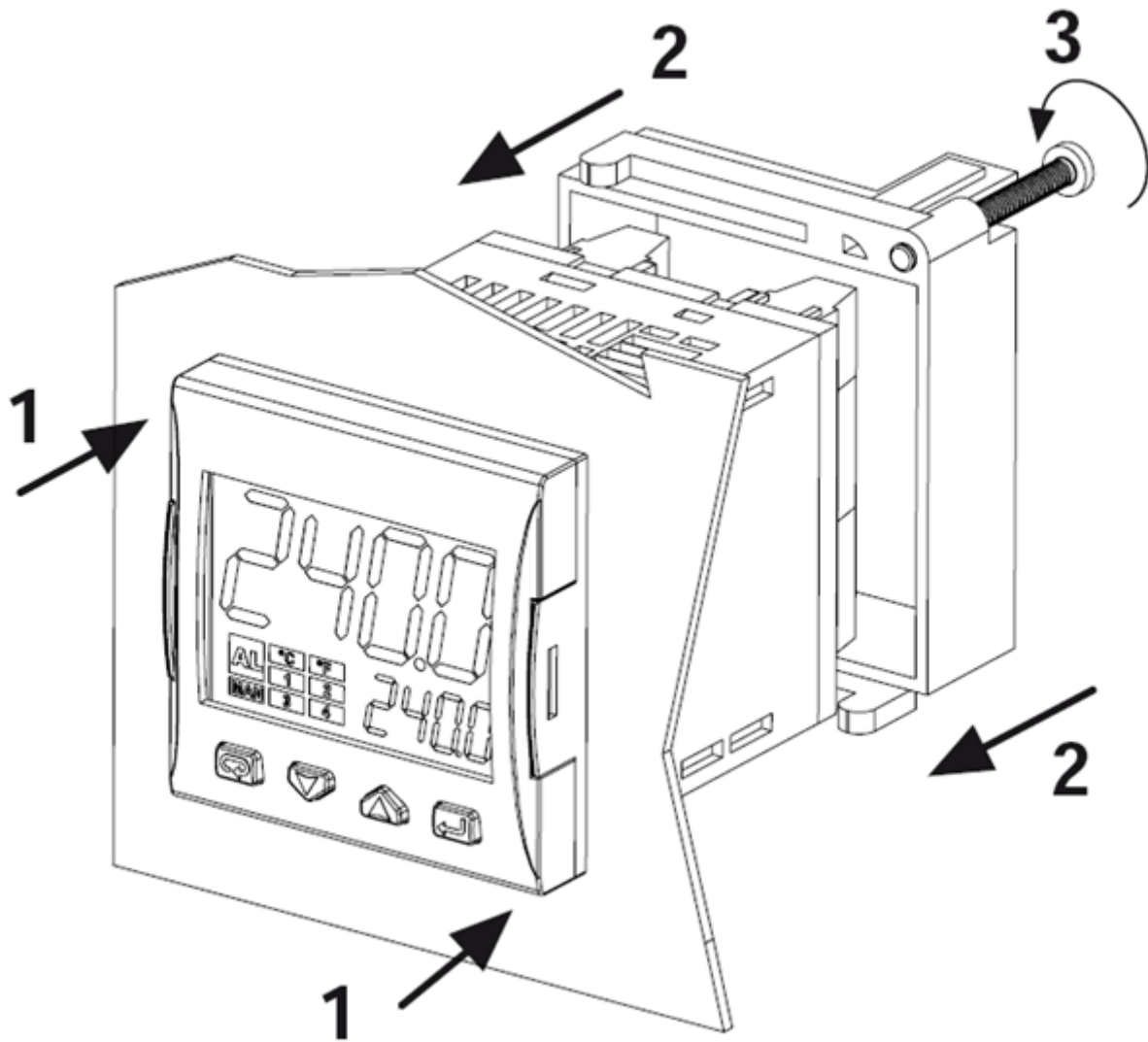

DISPLAY AND KEYS

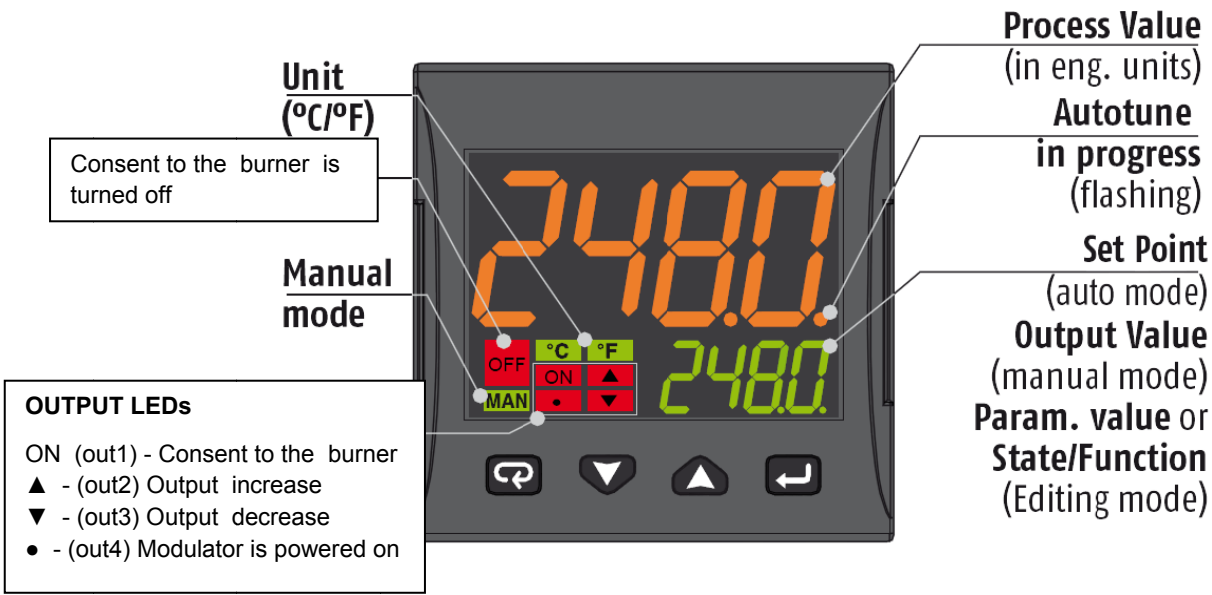

	Operator Mode	Editing Mode
	Access to: - Operator Commands (Timer, Setpoint selection ...) - Parameters - Configuration	Confirm and go to Next parameter
	Access to: - Operator additional information (Output value, running time ...)	Increase the displayed value or select the next element of the parameters list
	Access to: - Set Point	Decrease the displayed value or select the previous element
	Programmable key: Start the programmed function (Autotune, Auto/Man, Timer ...)	Exit from Operator commands/Parameter setting/Configuration

CONNECTIONS DIAGRAM

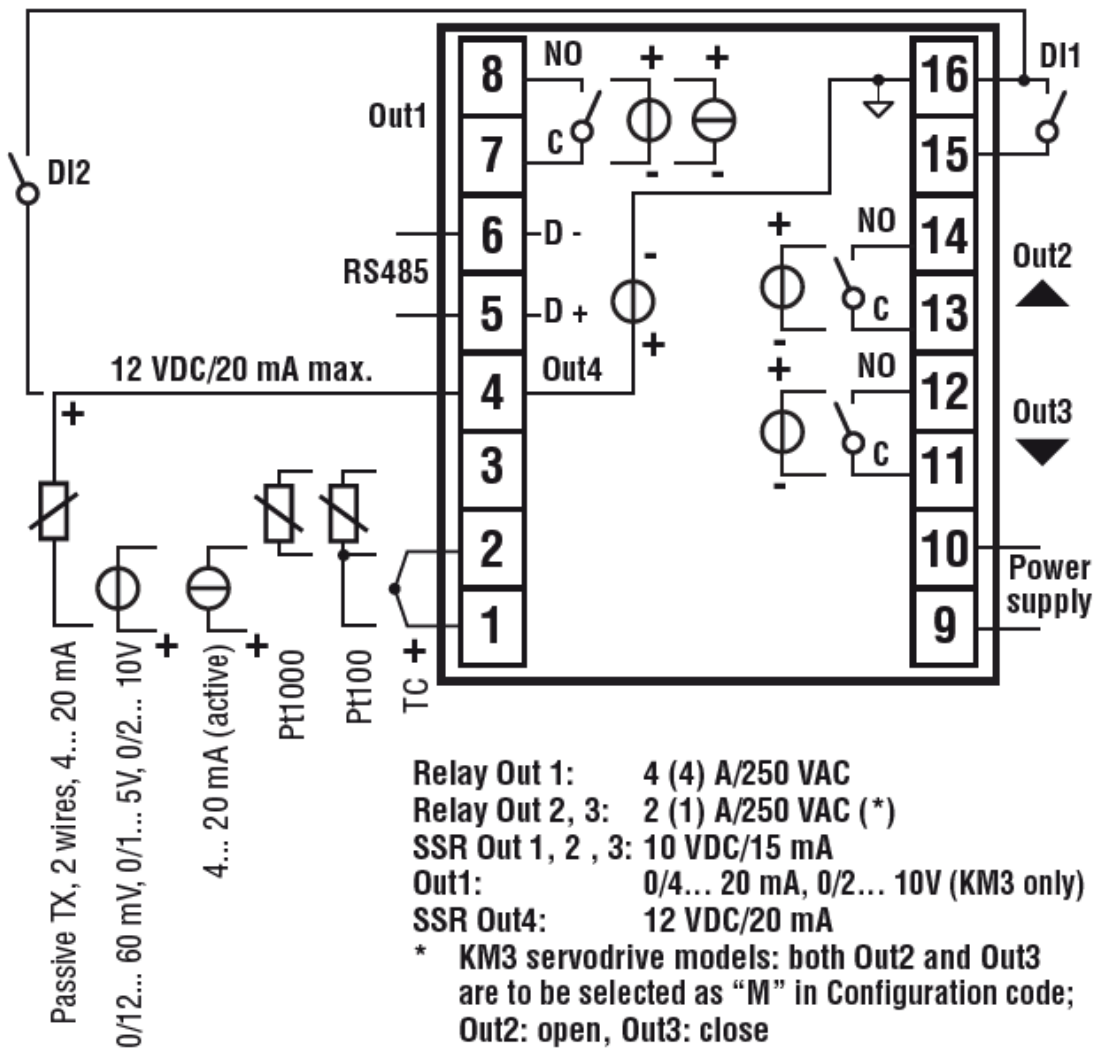

Probe connection:

- **PT1000/NTC/PTC:** between terminal 3 and 2
- **PT 100:** between terminal 3 and 2 with terminal 1
- **Passive pressure probe 0/4-20 mA:** between terminal 4 (+) e 1 (-)
Note: out4 must be activated (IO4F must be setted to ON)
- **Powered pressure probe 0/4-20 mA** between terminal 4 (power supply), 2 (negative) e 1 (positive)
Note: set IO4F to ON to activate Out4

Power supply connection:

- **Neutral wire:** terminal 9
- **Phase:** terminal 10 (100...240 Vac)
- Close terminals 15-16 to switch to the set point 2

Output connection:

- **Channel 1:** terminal 7 and 8 (burner on – off)
- **Channel 2:** terminal 11 and 12 (servomotor opens)
- **Channel 3:** terminal 13 and 14 (servomotor closes)

SETPOINT AND HYSTERESIS CONFIGURATION (SP, AL1, HAL1 parameters)

Push the  button to enter into the setpoint configuration:

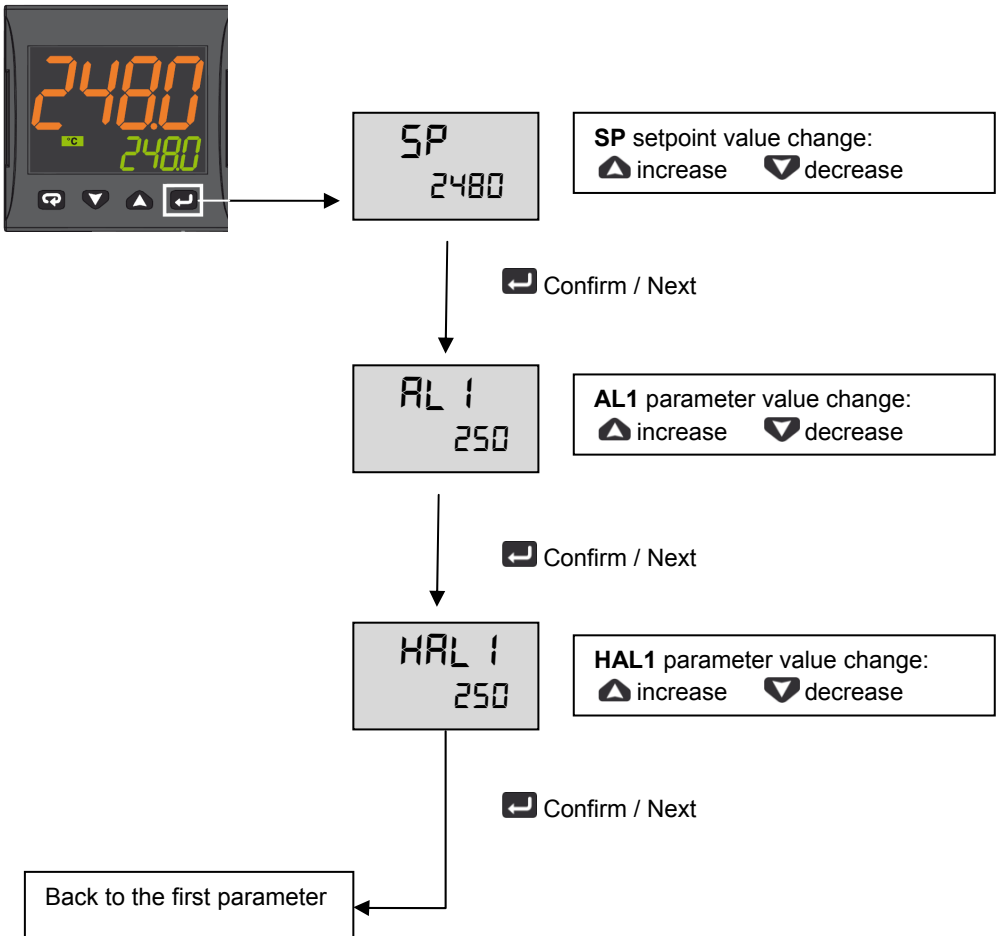

To return to normal mode, press the  key for 3 seconds or wait the 10s timeout

Operation example

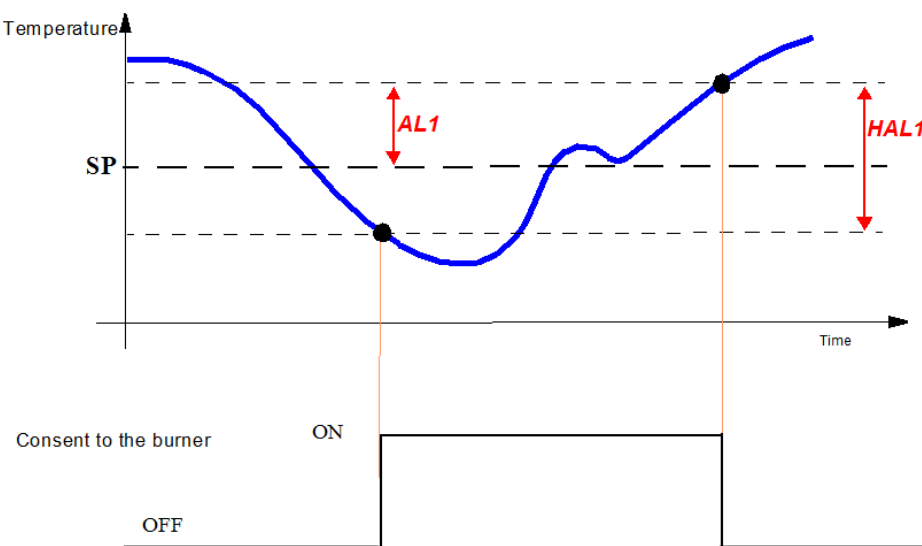

LIMITED ACCESS LEVEL

Proceed as follows to change some parameters that are not visible in standard user mode:

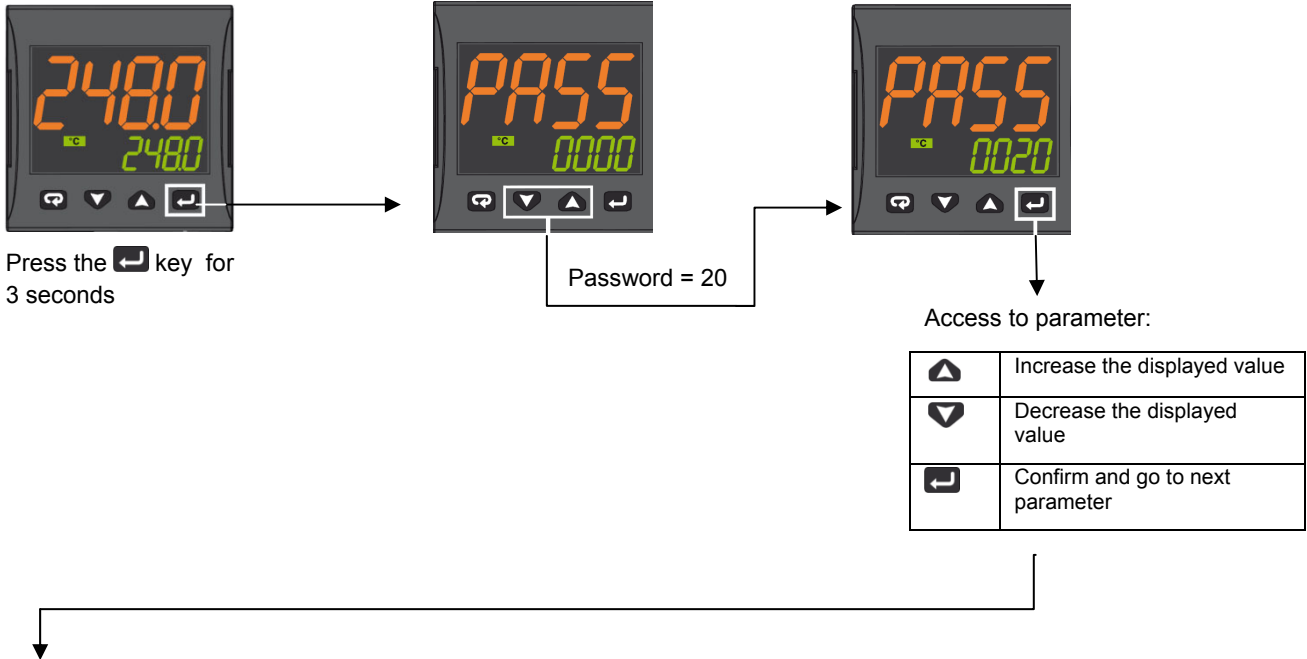

Param	Description	Values	Default
SEnS	Input type	Pt1 = RTD Pt100 Pt10 = RTD Pt1000 0.20 = 0..20mA 4.20 = 4..20mA Pressure probe 0.10 = 0..10V 2.10 = 2..10V crAL= Thermocouple K	Depends on the probe
SP	Set point 1	SPLL ... SPLH	See page 7
AL1	AL1 threshold	AL1L... AL1H (E.U.)	
HAL1	AL1 hysteresis	1... 9999 (E.U.)	
Pb	Proportional band	1... 9999 (E.U.)	
ti	Integral time	0 (oFF) ... 9999 (s)	
td	Derivative time	0 (oFF) ... 9999 (s)	
Str.t	Servomotor stroke time	5...1000 seconds	
db.S	Servomotor dead band	0...100%	
SPLL	Minimum set point value	-1999 ... SPLH	
SPLH	Maximum set point value	SPLL ... 9999	
dp	Decimal point position	0... 3	
SP 2	Set point 2	SPLL...SPLH	60
A.SP	Selection of the active set point	"SP" ... "nSP"	SP

To exit the parameter setting procedure press the key (for 3 s) or wait until the timeout expiration (about 30 seconds)

Probe parameters configuration MODULATORE ASCON KM3

Parameter Group	inP				AL1				rEG				SP			
	Sens	dp	SSC	FSc	unit	IO4.F (**)	AL1 (***)	HAL1 (***)	Pb (***)	ti (***)	td (***)	Str.t	db.S	SPLL	SPHL	SP (***)
Probes		Dec Point	Scale Min	Scale Max			Off	On	p	i	d	servo time s	Band Mo.	SP Min	SP Max	Set point
Pt1000 (130°C max)	Pt10	1			°C	on	5	10	10	350	1	*	5	30	95	80
Pt1000 (350°C max)	PT10	1			°C	on	10	10	10	350	1	*	5	0	350	80
Pt100 (130°C max)	PT1	1			°C	on	5	10	10	350	1	*	5	0	95	80
Pt100 (350°C max)	Pt1	1			°C	on	10	10	10	350	1	*	5	0	350	80
Pt100 (0÷100°C 4÷20mA)	4.20	1	0	100		on	5	10	10	350	1	*	5	0	95	80
Thermocouple K (1200°C max)	crAL	0			°C	on	20	25	10	350	1	*	5	0	1200	80
Thermocouple J (1000°C max)	J	0			°C	on	20	25	10	350	1	*	5	0	1000	80
4-20mA / 0-1,6bar Pressure probe	4.20	0	0	160		on	20	20	5	120	1	*	5	0	160	100
4-20mA / 0-10bar Pressure probe	4.20	0	0	1000		on	50	50	5	120	1	*	5	0	1000	600
4-20mA / 0-16bar Pressure probe	4.20	0	0	1600		on	80	80	5	120	1	*	5	0	1600	600
4-20mA / 0-25bar Pressure probe	4.20	0	0	2500		on	125	125	5	120	1	*	5	0	2500	600
4-20mA / 0-40bar Pressure probe	4.20	0	0	4000		on	200	200	5	120	1	*	5	0	4000	600
QBE2002 / 0-25bar Pressure probe	0.10	0	0	2500		0n	125	125	5	120	1	*	5	0	2500	600

Note:

(*) Str.t - Servomotor stroke time

SQL33; STM30; SQM10; SQM40; SQM50; SQM54 = 30 (Seconds)

STA12B3.41; SQN30.251; SQN72.4A4A20 = 12 (Seconds)

() Out 4 ... on Display led °4 must be switched on, otherwise change the io4.F parameter value from "on" to "out4", confirm the value, quit the configuration mode then change again the io4.F parameter value from "out4" to "on".**







(***) Factory settings. These values must be adapted to machine conditions

N.B. For pressure probe, SP, SPHL, SPLL parameters values are expressed in Kpa (1 bar = 100 Kpa).

CONFIGURATION









How to access configuration level

The configuration parameters are collected in various groups. Every group defines all parameters related with a specific function (e.g.: control, alarms, output functions).

1. Push the  button for more than 5 seconds. The upper display will show PASS while the lower display will show 0.
2. Using  and  buttons set the programmed password.
According to the entered password, it is possible to see a part of the parameters listed in the "configuration parameters" section.
 - a. Enter "30" as password to view all the configuration parameters
 - b. Enter "20" as password to view the parameters of the "limited access level". At this point, only the parameters with attribute **Liv = A** or **Liv = O** will be editable.
 - c. Leave the password blank to edit "user level" parameters, that are identified by attribute **Liv = O**
3. Push the  button. If the password is correct the display will show the acronym of the first parameter group preceded by the symbol: . In other words the upper display will show:  inP (group of the **Input parameters**).

The instrument is in configuration mode. To press  for more than 5 seconds, the instrument will return to the "standard display".

Keyboard functions during parameter changing:

Operator Mode	
	When the upper display is showing a group and the lower display is blank, this key allows to enter in the selected group. When the upper display is showing a parameter and the lower display is showing its value, this key allows to store the selected value for the current parameter and access the next parameter within the same group.
	Allows to increase the value of the selected parameter.
	Allows to decrease the value of the selected parameter.
	Short presses allow you to exit the current group of parameters and select a new group. A long press terminates the configuration procedure (the instrument returns to the normal display).
 + 	These two keys allow to return to the previous group. Proceed as follows: Push the  button and maintaining the pressure, then push the  ; release both the buttons.

Configuration Parameters

inP GROUP - input configuration					
Liv	N°	Param	Description	Values	Default
A	1	SEnS	Input type	Pt1 = RTD Pt100 Pt10 = RTD Pt1000 0.20 = 0..20mA 4.20 = 4..20mA Pressure probe 0.10 = 0..10V 2.10 = 2..10V crAL= Thermocouple K	Depends on the probe
A	2	dp	Decimal point position	0... 3	See page 7
A	3	SSc	Initial scale read-out for linear inputs (available only if SEnS parameter is not equal to Pt1, Pt10, crAL values)	-1999... 9999	0
C	4	FSc	Full scale read-out for linear input inputs (available only if SEnS parameter is not equal to Pt1, Pt10, crAL values)	-1999... 9999	Depends on the probe
C	5	unit	Unit of measure (present only in the case of temperature probe)	°C/°F	°C
C	6	Fil	Digital filter on the measured value	0 (= OFF)... 20.0 s	1.0
C	7	inE	Selection of the Sensor Out of Range type that will enable the safety output value	or = Over range ou = Under range our = over e under range	or

C	8	oPE	Safety output value	-100... 100	0
C	9	io4.F	I/O4 function selection	on = Out4 will be ever ON (used as a transmitter power supply) ,out4 = Uscita 4 (Used as digital output 4), dG2c = Digital input 2 for contact closure, dG2U = Digital input 2 driven by 12... 24 VDC	on
C	10	diF1	Digital input 1 function	oFF = Not used, 1 = Alarm reset, 2 = Alarm acknowledge (ACK), 3 = Hold of the measured value, 4 = Stand by mode, 5 = Manual mode, 6 = HEAt with SP1 and Cool with SP2, 7 = Timer RUN/Hold/Reset, 8 = Timer Run, 9 = Timer Reset, 10 = Timer Run/Hold, 11 = Timer Run/Reset, 12 = Timer Run/Reset with lock, 13 = Program Start, 14 = Program Reset, 15 = Program Hold, 16 = Program Run/Hold, 17 = Program Run/Reset, 18 = Sequential SP selection, 19 = SP1 - SP2 selection, 20 = SP1... SP4 binary selection, 21 = Digital inputs in parallel	19
C	12	di.A	Digital Inputs Action (DI2 only if configured)	0 = DI1 direct action, DI2 direct action 1 = DI1 reverse action, DI2 direct action 2 = DI1 direct action, DI2 reverse action 3 = DI1 reverse action, DI2 reverse action	0

Out GROUP- Output parameters

Liv	N°	Param	Description	Values	Default
C	14	o1F	Out 1 function	AL = Alarm output	AL
C	15	o1AL	Initial scale value of the analog retransmission	-1999 ... Ao1H	1
C	18	o1Ac	Out 1 action	dir = Direct action rEU = Reverse action dir.r = Direct with reversed LED ReU.r = Reverse with reversed LED	rEU.r
C	19	o2F	Out 2 function	H.rEG = Heating output	H.rEG
C	21	o2Ac	Out 2 action	dir = Direct action rEU = Reverse action dir.r = Direct with reversed LED ReU.r = Reverse with reversed LED	dir
C	22	o3F	Out 3 function	H.rEG = Heating output	H.rEG
C	24	o3Ac	Out 3 action	dir = Direct action rEU = Reverse action dir.r = Direct with reversed LED ReU.r = Reverse with reversed LED	dir

AL1 GROUP - Alarm 1 parameters

Liv	N°	Param	Descrizione	Values	Default
C	28	AL1t	Tipo allarme AL1	nonE = Alarm not used LoAb = Absolute low alarm HiAb = Absolute high alarm LHAo = Windows alarm in alarm outside the windows LHAI = Windows alarm in alarm inside the	HidE

				windows SE.br = Sensor Break LodE = Deviation low alarm (relative) HidE = Deviation high alarm (relative) LHdo = Relative band alarm in alarm out of the band LHdi = Relative band alarm in alarm inside the band	
C	29	Ab1	Alarm 1 function	0... 15 +1 = Not active at power up +2 = Latched alarm (manual reset) +4 = Acknowledgeable alarm +8 = Relative alarm not active at set point change	0
C	30	AL1L	-- For High and low alarms, it is the low limit of the AL1 threshold; -- For band alarm, it is low alarm threshold	-1999... AL1H (E.U.)	-199.9
C	31	AL1H	-- For High and low alarms, it is the high limit of the AL1 threshold; -- For band alarm, it is high alarm threshold	AL1L... 9999 (E.U.)	999.9
O	32	AL1	AL1 threshold	AL1L... AL1H (E.U.)	See page 7
O	33	HAL1	AL1 hysteresis	1... 9999 (E.U.)	See page 7
C	34	AL1d	AL1 delay	0 (oFF)... 9999 (s)	oFF
C	35	AL1o	Alarm 1 enabling during Stand-by mode and out of range conditions	0 = Alarm 1 disabled during Stand by and out of range 1 = Alarm 1 enabled in stand by mode 2 = Alarm 1 enabled in out of range condition 3 = Alarm 1 enabled in stand by mode and in overrange condition	1

GRUPPO AL2 - parametri allarme 2

Liv	N°	Param	Description	Values	Default
C	36	AL2t	Alarm 2 type	nonE = Alarm not used LoAb = Absolute low alarm HiAb = Absolute high alarm LHAo = Windows alarm in alarm outside the windows LHAI = Windows alarm in alarm inside the windows SE.br = Sensor Break LodE = Deviation low alarm (relative) HidE = Deviation high alarm (relative) LHdo = Relative band alarm in alarm out of the band LHdi = Relative band alarm in alarm inside the band	SE.br
C	37	Ab2	Alarm 2 function	0... 15 +1 = Not active at power up +2 = Latched alarm (manual reset) +4 = Acknowledgeable alarm +8 = Relative alarm not active at set point change	0
C	42	AL2d	AL2 hysteresis	0 (oFF)... 9999 (s)	oFF
C	43	AL2o	Alarm 2 enabling during Stand-by mode and out of range conditions	0 = Alarm 2 disabled during Stand by and out of range 1 = Alarm 2 enabled in stand by mode 2 = Alarm 2 enabled in out of range condition 3 = Alarm 2 enabled in stand by mode and in overrange condition	0

AL3 Group - alarm 3 parameters					
Liv	N°	Param	Description	Values	Default
	44	AL3t	Alarm 3 type	nonE = Alarm not used LoAb = Absolute low alarm HiAb = Absolute high alarm LHAo = Windows alarm in alarm outside the windows LHAI = Windows alarm in alarm inside the windows SE.br = Sensor Break LodE = Deviation low alarm (relative) HidE = Deviation high alarm (relative) LHdo = Relative band alarm in alarm out of the band LHdi = Relative band alarm in alarm inside the band	nonE

LbA Group - Loop break alarm					
Liv	N°	Param	Descrizione	Values	Default
C	52	LbAt	LBA time	Da 0 (oFF) a 9999 (s)	oFF

rEG Group - Control parameters					
Liv	N°	Param	Description	Values	Default
C	56	cont	Control type	Pid = PID (heat and/or) On.FA = ON/OFF asymmetric hysteresis On.FS = ON/OFF symmetric hysteresis nr = Heat/Cool ON/OFF control with neutral zone 3Pt = Servomotor control (available only when Output 2 and Output 3 have been ordered as "M")	3pt
C	57	Auto	Autotuning selection	-4 = Oscillating auto-tune with automatic restart at power up and after all point change -3 = Oscillating auto-tune with manual start -2 = Oscillating -tune with auto-matic start at the first power up only -1 = Oscillating auto-tune with auto-matic restart at every power up 0 = Not used 1 = Fast auto tuning with automatic restart at every power up 2 = Fast auto-tune with automatic start the first power up only 3 = FAST auto-tune with manual start 4 = FAST auto-tune with automatic restart at power up and after set point change 5 = Evo-tune with automatic restart at every power up 6 = Evo-tune with automatic start the first power up only 7 = Evo-tune with manual start 8 = Evo-tune with automatic restart at power up and after a set point change	7
C	58	tunE	Manual start of the Autotuning	oFF = Not active on = Active	oFF

C	59	SELF	Self tuning enabling	no = The instrument does not perform the self-tuning YES = The instrument is performing the self-tuning	No
A	62	Pb	Proportional band	1... 9999 (E.U.)	See page 7
A	63	ti	Integral time	0 (oFF) ... 9999 (s)	See page 7
A	64	td	Derivative time	0 (oFF) ... 9999 (s)	See page 7
C	65	Fuoc	Fuzzy overshoot control	0.00... 2.00	1
C	69	rS	Manual reset (Integral pre-load)	-100.0... +100.0 (%)	0.0
A	70	Str.t	Servomotor stroke time	5...1000 seconds	See page 7
A	71	db.S	Servomotor dead band	0...100%	5
C	72	od	Delay at power up	0.00 (oFF) ... 99.59 (hh.mm)	oFF

SP Group - Set point parameters

Liv	N°	Param	Description	Values	Default
C	76	nSP	Number of used set points	1... 4	2
A	77	SPLL	Minimum set point value	-1999 ... SPHL	See page 7
A	78	SPHL	Maximum set point value	SPLL ... 9999	See page 7
O	79	SP	Set point 1	SPLL ... SPLH	See page 7
C	80	SP 2	Set point 2	SPLL ... SPLH	60
	83	A.SP	Selection of the active set point	"SP" ... "nSP"	SP
C	84	SP.rt	Remote set point type	RSP = The value coming from serial link is used as remote set point trin = The value will be added to the local set point selected by A.SP and the sum becomes the operative set point PErc = The value will be scaled on the input range and this value will be used as remote SP	trin
C	85	SPLr	Local/remote set point selection	Loc = Local rEn = Remote	Loc
C	86	SP.u	Rate of rise for POSITIVE set point change (ramp UP)	0.01... 99.99 (inF) Eng. units per minute	inF
C	87	SP.d	Rate of rise for NEGATIVE set point change (ramp DOWN)	0.01... 99.99 (inF) Eng. units per minute	inF

PAn Group - Operator HMI

Liv	N°	Param	Description	Values	Default
C	118	PAS2	Level 2 password (limited access level)	oFF (Level 2 not protected by password) 1... 200	20
C	119	PAS3	Level 3 password (complete configuration level)	3... 300	30
C	120	PAS4	Password livello (livello configurazione a codice)	201... 400	300
C	121	uSrb	button function during RUN TIME	nonE = No function tunE = Auto-tune/self-tune enabling. A single press (longer than 1 second) starts the auto-tune oPLo = Manual mode. The first pressure puts the instrument in manual mode (OPLO) while a second one puts the instrument in Auto mode	tunE

				AAC = Alarm reset ASi = Alarm acknowledge chSP = Sequential set point selection St.by = Stand by mode. The first press puts the instrument in stand by mode while a second one puts the instrument in Auto mode. Str.t = Timer run/hold/reset P.run = Program run P.rES = Program reset P.r.H.r = Program run/hold/reset	
C	122	diSP	Display management	Spo = Operative set point	SPO
C	123	di.cL	Display colour	0 = The display colour is used to show the actual deviation (PV - SP) 1 = Display red (fix) 2 = Display green (fix) 3 = Display orange (fix)	2
	125	diS.t	Display Timeout	-- oFF (display always ON) -- 0.1... 99.59 (mm.ss)	oFF
C	126	fiLd	Filter on the displayed value	-- oFF (filter disabled) -- From 0.0 (oFF) to 20.0 (E.U.)	oFF
C	128	dSPu	Instrument status at power ON	AS.Pr = Starts in the same way it was prior to the power down Auto = Starts in Auto mode oP.0 = Starts in manual mode with a power output equal to zero St.bY = Starts in stand-by mode	Auto
C	129	oPr.E	Operative modes enabling	ALL = All modes will be selectable by the next parameter Au.oP = Auto and manual (OPLO) mode only will be selectable by the next parameter Au.Sb = Auto and Stand-by modes only will be selectable by the next parameter	ALL
C	130	oPEr	Operative mode selection	If oPr.E = ALL: - Auto = Auto mode - oPLo = Manual mode - St.bY = Stand by mode If oPr.E = Au.oP: - Auto = Auto mode - oPLo = Manual mode If oPr.E = Au.Sb: - Auto = Auto mode - St.bY = Stand by mode	Auto

SEr Group - Serial link parameter

Liv	N°	Param	Description	Values	Default
C	131	Add	Instrument address	-- oFF -- 1... 254	1
C	132	bAud	baud rate	1200 = 1200 baud 2400 = 2400 baud 9600 = 9600 baud 19.2 = 19200 baud 38.4 = 38400 baud	9600
C	133	trSP	Selection of the value to be retransmitted (Master)	nonE = Retransmission not used (the instrument is a slave) rSP = The instrument becomes a Master and retransmits the operative set point PErc = The instrument become a Master and it retransmits the power output	nonE

con Group - Consumption parameters					
Liv	N°	Param	Description	Values	Default
C	134	Co.tY	Count type	<p>oFF = Not used</p> <p>1 = Instantaneous power (kW)</p> <p>2 = Power consumption (kW/h)</p> <p>3 = Energy used during program execution. This measure starts from zero when a program runs end stops at the end of the program. A new program execution will reset the value</p> <p>4 = Total worked days: number of hours the instrument is turned ON divided by 24.</p> <p>5 = Total worked hours: number of hours the instrument is turned ON.</p> <p>6 = Total worked days with threshold: number of hours the instrument is turned ON divided by 24, the controller is forced in stand-by when Co.ty value reaches the threshold set in [137] h.Job.</p> <p>7 = Total worked hours with threshold: number of hours the instrument is turned ON, the controller is forced in stand-by when Co.ty value reaches the threshold set in [137] h.Job.</p> <p>8 = Totalizer of control relay worked days: number of hours the control relay has been in ON condition, divided by 24.</p> <p>9 = Totalizer of control relay worked hours: number of hours the control relay has been in ON condition.</p> <p>10 = Totalizer of control relay worked days with threshold: number of hours the control relay has been in ON condition divided by 24, the controller is forced in stand-by when Co.ty value reaches the threshold set in [137] h.Job.</p> <p>11 = Totalizer of control relay worked hours with threshold: number of hours the control relay has been in ON condition, the controller is forced in stand-by when Co.ty value reaches the threshold set in [137] h.Job.</p>	oFF
C	138	t.Job	Worked time (not resettable)	0... 9999 days	0

cAL Group - User calibration group					
Liv	N°	Param	Description	Values	Default
C	139	AL.P	Adjust Low Point	From -1999 to (AH.P - 10) in engineering units	0
C	140	AL.o	Adjust Low Offset	-300... +300 (E.U.)	0
C	141	AH.P	Adjust High Point	From (AL.P + 10) to 9999 engineering units	999.9
C	142	AH.o	Adjust High Offset	-300... +300	0

OPERATIVE MODES

When the instrument is powered, it starts immediately to work according to the parameters values loaded in its memory. The instrument behaviour and its performance are governed by the value of the stored parameters.

At power ON the instrument can start in one of the following mode depending on its configuration:

Automatic Mode In Automatic mode the instrument drives automatically the control output according to the parameter value set and the set point/measured value.

Manual Mode (OPLO): In Manual mode the the upper display shows the measured value while the lower display shows the power output The lower display shows the power output [preceded by H (for heating) or C (for cooling)], MAN is lit and the instrument allows you to set manually the control output power. No Automatic action will be made.





Stand by Mode (St.bY): In stand-by mode the instrument operates as an indicator. It will show on the upper display the measured value and on the lower display the set point alternately to the "St.bY" messages and forces the control outputs to zero.

We define all the above described conditions as "Standard Display".

As we have seen, it is always possible to modify the value assigned to a parameter independently from the operative modes selected.









AUTOMATIC MODE

Keyboard function when the instrument is in Auto mode:

Modo Operatore	
	Allows entry into parameter modification procedures
	Allows you to start the "Direct set point modification" function (see below).
	Allows you to display the "additional informations" (see below).
	Performs the action programmed by [121] uSrb ( button function during RUN TIME) parameter

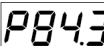
Additional information





This instrument is able to show you some additional informations that can help you to manage your system. The additional informations are related to how the instrument is programmed, hence in many cases, only part of this information is available.

1. When the instrument is showing the "standard display" push  button. The lower display will show H or c followed by a number. This value is the current power output applied to the process. The H show you that the action is a Heating action while the "c" show you that the action is a Cooling action
2. Push  button again. When the programmer is running the lower display will show the segment currently performed and the Event status as shown below:
 where the first character can be r for a ramp or S for a soak, the next digit show the number of the segment (e.g. S3 means Soak number 3) and the twoless significant digits (LSD) show you the status of the two event (the LSD is the Event 2)..
3. Push  button again. When the programmer is running the lower display will show the theoretical remaining time to the end of the program preceded by a "P" letter:

4. Push  button again. When the wattmeter function is running the lower display will show U followed by the measured energy..
5. Push  button. When the "Worked time count" is running the lower display will show "d" for days or "h" for hours followed by the measured time.
6. Push  button. The instrument returns to the "standard display".



Note: The additional information visualization is subject to a time out. If no button is pressed for more than 10 second the instrument comes automatically back to the Standard display..

Direct set point modification

This function allows to modify rapidly the set point value selected by [83] A.SP (selection of the active Set point) or to the set point of the segment group (of the programmer) currently in progress.

1. Push  button. The upper display shows the acronym of the selected set point (e.g. SP2) and the lower display will show its value.
2. By  and  buttons, assign to this parameter the desired value
3. Do not push any button for more than 5 second or push the  button. In both cases the instrument memorize the new value and come back to the “standard display”.

Manual mode

This operative mode allows you to deactivate automatic control and manually program the percentage power output to the process. When the instrument is in manual mode, the upper display shows the measured value while the lower display shows the power output [preceded by H (for heating action) or C (for cooling action)] The MAN LED is lit. When manual control is selected, the instrument will start to operate with the same power output as the last one supplied by automatic mode and can be modified using the  and  buttons.

In case of ON/OFF control, 0% corresponds to the deactivated output while any value different from 0 corresponds to the activated output. As in the case of visualization, the programmable values range from H100 (100% output power with reverse action) to C100 (100% output power with direct action).

Notes:

- During manual mode, the alarms are operative.
- If you set manual modes during program execution, the program will be frozen and it will restart when the instrument will come back to Auto mode.
- If you set manual modes during self-tune execution, the self- tune function will be aborted.
- During manual mode, all functions not related with the control (wattmeter, independent timer, “worked time”, etc) continue to operate normally..

STAND-BY MODE

This operative mode also deactivates the automatic control but forces the control output to zero. In this mode the instrument operates as an indicator. When the instrument is in stand by mode the upper display will show the measured value while the lower display will show alternately the set point and the message “St.bY”.

Notes:

- During stand by mode, the relative alarms are disabled while the absolute alarms are operative or not according to the ALx0 (Alarm x enabling during Stand-by mode) parameter setting.
- If you set stand by mode during program execution, the program will be aborted.
- If you set stand by mode during self-tune execution, the self- tune function will be aborted.
- During stand by mode, all functions not related with the control (wattmeter, independent timer, “worked time”, etc) continue to operate normally.
- When the instrument is swapped from stand by to auto modes, the instrument will start automatically the alarm masking, the soft start functions and the auto-tune (if programmed).

AUTOTUNE (EVOTUNE)

Evotune is a fast and fully automatic procedure that can be started in any condition, regardless the deviation from SP. The controller selects automatically the best tune method and computes the optimum PID parameters. To activate Evotune press  button for 3 seconds.

ERROR MESSAGES

The upper display shows the OVER-RANGE and UNDERRANGE conditions with the following indications:

Over-range: 

Under-range 

The sensor break will be signalled as an out of range: - - - -

Note: When an over-range or an under-range is detected, the alarms operate as in presence of the maximum or the minimum measurable value respectively.

To check the out of span Error condition, proceed as follows:

1. Check the input signal source and the connecting line.
2. Make sure that the input signal is in accordance with the instrument configuration. Otherwise, modify the input configuration.
3. If no error is detected, send the instrument to your supplier to be checked.

List of possible errors

ErAT Fast Auto-tune cannot start. The measure value is too close to the set point. Push the button in order to delete the error message.

ouLd Overload on the out 4. The messages shows that a short circuit is present on the Out 4 when it is used as output or as a transmitter power supply. When the short circuit disappears the output restart to operate..

NoAt Auto-tune not finished within 12 hours.

ErEP Possible problem of the instrument memory. The messages disappears automatically. When the error continues, send the instrument to your supplier.





RonE Possible problem of the firmware memory. When this error is detected, send the instrument to your supplier.

Errt Possible problem of the calibration memory. When this error is detected, send the instrument to your supplier.

FACTORY RESET

Sometime, e.g. when you re-configure an instrument previously used for other works or from other people or when you have made too many errors during configuration and you decided to re-configure the instrument, it is possible to restore the factory configuration. This action allows to put the instrument in a defined condition (the same it was at the first power ON).

The default data are those typical values loaded in the instrument prior to ship it from factory. To load the factory default parameter set, proceed as follows:

1. Press the  button for more than 5 seconds. The upper display will show PASS while the lower display shows 0;
2. Using  and  buttons set the value -481;
3. Push  button;
4. The instrument will turn OFF all LEDs for a few seconds, then the upper display will show dFLt (default) and then all LEDs are turned ON for 2 seconds. At this point the instrument restarts as for a new power ON.

The procedure is complete.

Note: The complete list of the default parameters is available in Chapter "Configuration".

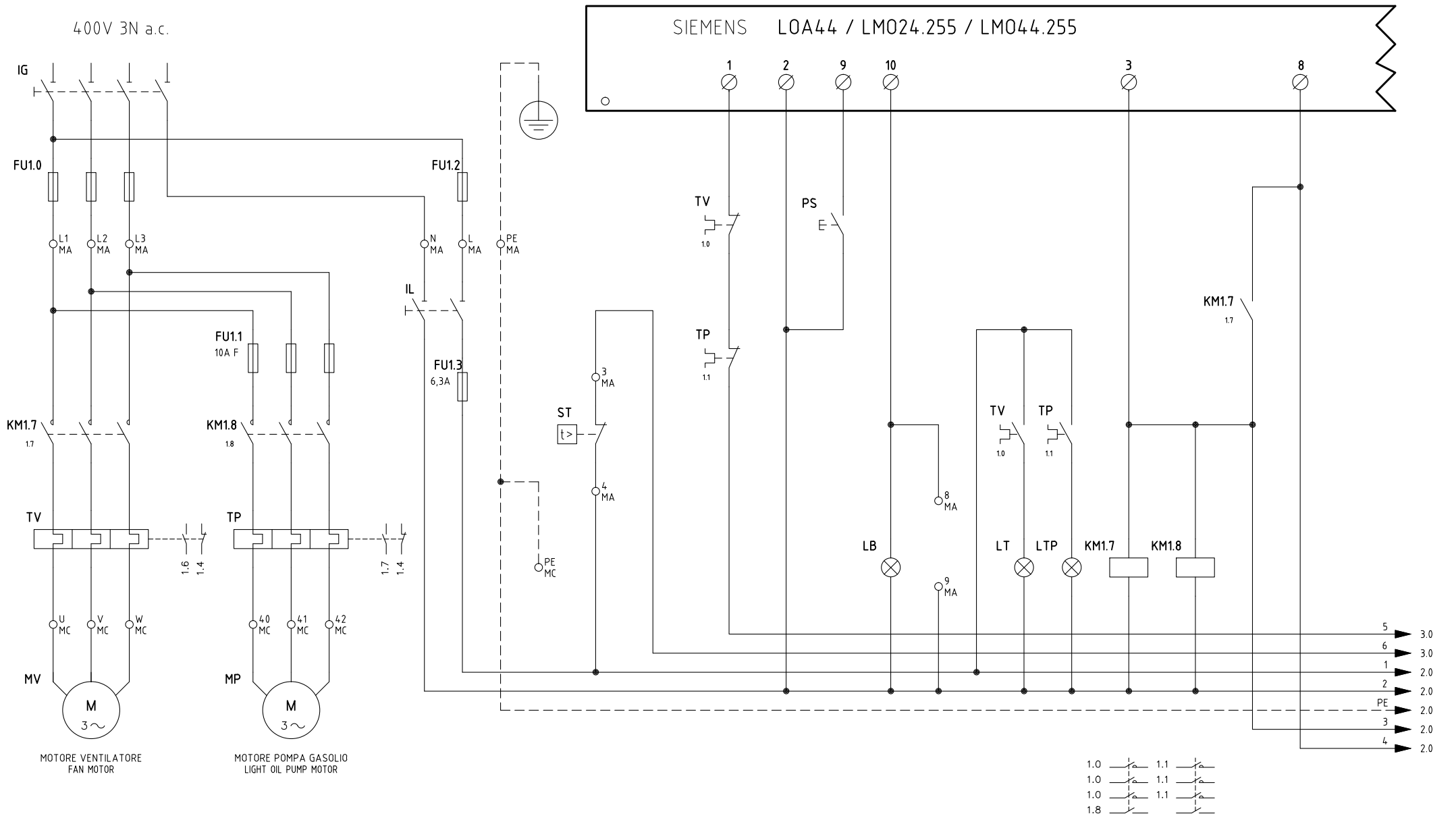

05	AGGIUNTO/ADDED LM024.255	07/01/13	U. PINTON
04	AGGIUNTO/ADDED "600V"	30/07/12	U. PINTON
03	ADDED "RWF50.2X" AND "POMAX"	19/04/12	U. PINTON
02	AGGIUNTO/ADDED SQM40.265A	12/11/09	U. PINTON
06	ADDED "KM3" AND "RWF55" MODULATOR	05/02/15	U. PINTON
REV.	MODIFICA	DATA	FIRME



Impianto
TIPI/TYPES PG70 ÷ PG93 / RG91 ÷ RG93
MODELLO/MODEL G-.MD.x.xx.Y

Descrizione
CON MOTORE POMPA SEPARATO
WITH SEPARATE PUMP MOTOR

Ordine	
Commessa	Data Controllato 05/02/2015
Esecutore U. PINTON	Controllato G. SCATTOLIN

Data	05/09/2006	PREC.	FOGLIO
Revisione	06	/	1
Dis. N.	07 - 0479	SEQUE	TOTALE
		2	6

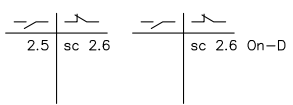
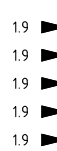
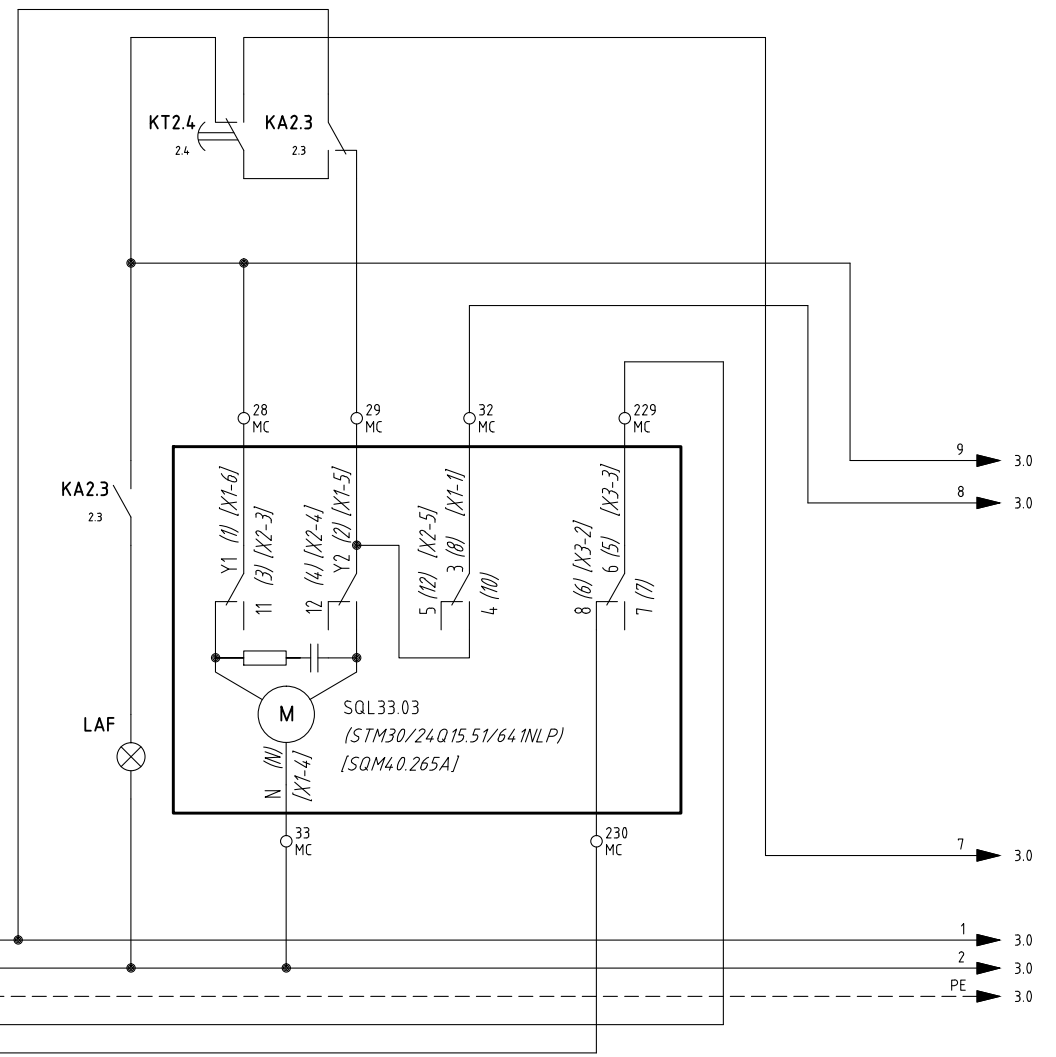
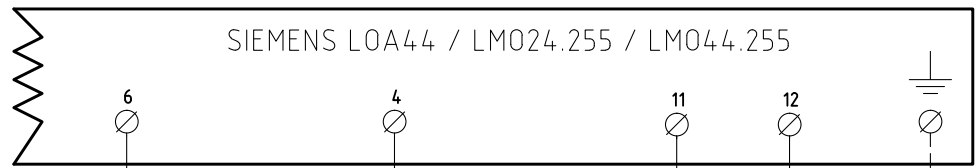

Data	05/09/2006	PREC.	FOGLIO
Revisione	06	1	2
Dis. N.	07 - 0479	SEGUE	TOTALE
		3	6

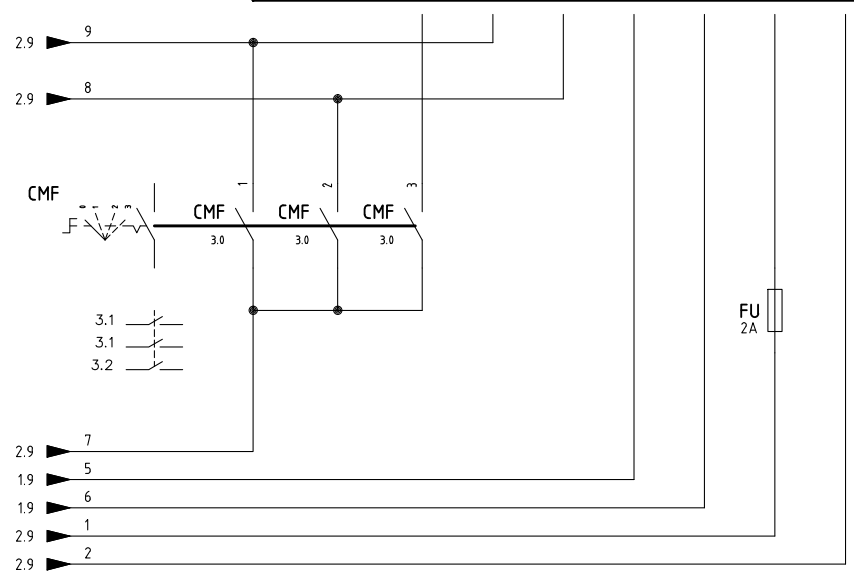
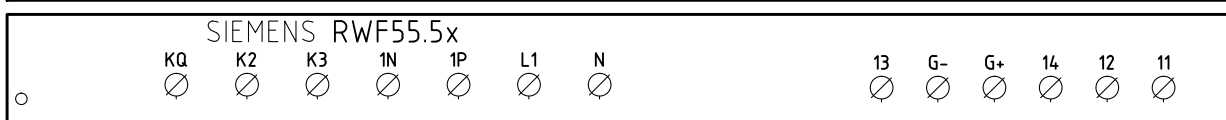
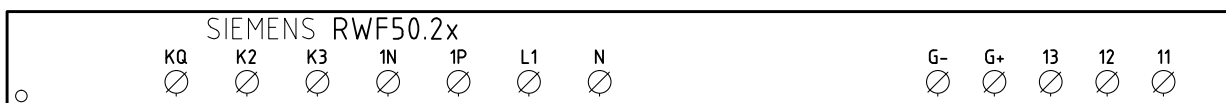
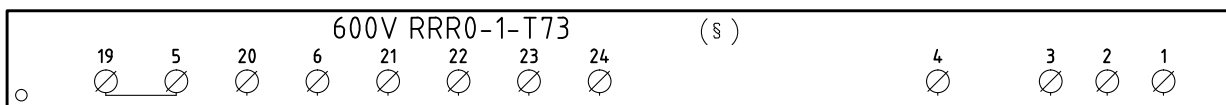
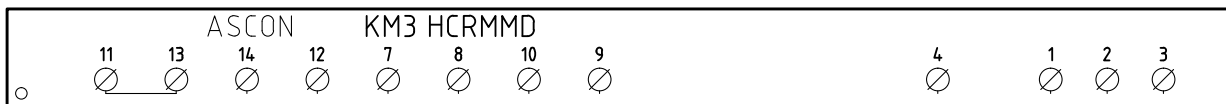

CONN. 7 PINS

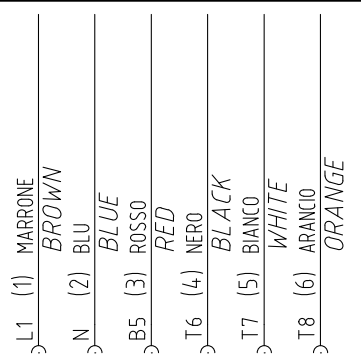

CAVO 7x0,75mmq
7x0,75mmq CABLE

(xx)
ATTENZIONE COLLEGAMENTO SONDE CON CONNETTORE 7 POLI
WARNING PROBE CONNECTION WITH 7 PINS CONNECTOR

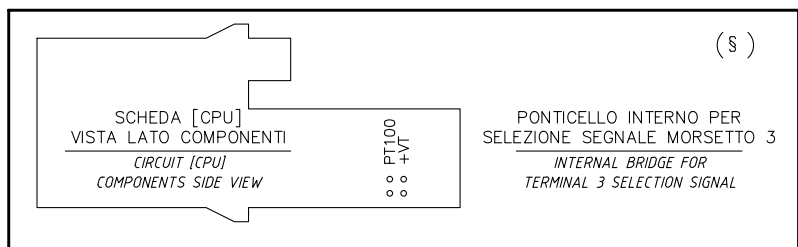

§
VERSIONE (PR) / VERSIONE (MD) CON RWF.. / 600V / KM3
(PR) VERSION / (MD) VERSION WITH RWF.. / 600V / KM3

Data	05/09/2006	PREC.	FOGLIO
Revisione	06	2	3
Dis. N.	07 - 0479	SEQUE	TOTALE
		4	6

(xx)

ATTENZIONE COLLEGAMENTO SONDE CON CONNETTORE 7 POLI
 WARNING PROBE CONNECTION WITH 7 PINS CONNECTOR

KM3 HCRMMD

600V RRR0-1-T73

RWF55.5x

RWF50.2x

SD-TEMP.

PT1000
1000 OHM 0°C

TC

SD - 4±20mA

SD - 0±10V

SD-PRESS

SIEMENS
QBE...

PT100 (S)
 OO OO +VT
 OO OO

3 = PT100
 3 = +VT

PONTECILLO INTERNO PER SELEZIONE SEGNALE MORSETTO 3
 INTERNAL BRIDGE FOR TERMINAL 3 SELECTION SIGNAL

PT100
100 OHM 0°C

TC

SD - 4±20mA

SD - 0±10V

SD-PRESS

SIEMENS
QBE...

SD-TEMP.
SD-TEMP. SIEMENS

PT1000
1000 OHM 0°C

TC

SD - 4±20mA

SD - 0±10V

SD-PRESS

SIEMENS
QBE...
0±10V

SD-TEMP.
SD-TEMP. SIEMENS

PT1000
1000 OHM 0°C

SD - 4±20mA

SD - 0±10V

SD-PRESS

SIEMENS
QBE...
0±10V

(#)
 COLLEGAMENTO SOLO PER
 TRASDUTTORI PASSIVI
 TRANSDUCER PASSIVE
 CONNECTION ONLY

Data	05/09/2006	PREC.	FOGLIO
Revisione	06	3	4
Dis. N.	07 - 0479	SEGUE	TOTALE
		5	6

QG - MA
MORSETTIERA ALIMENTAZIONE
SUPPLY TERMINAL BOARD

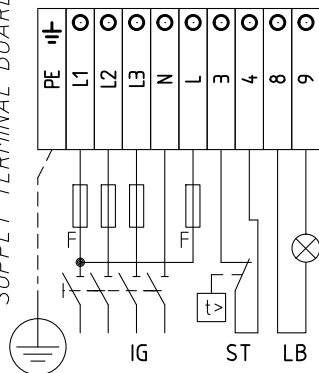

QG - MC
MORSETTIERA COMPONENTI
COMPONENT TERMINAL BOARD

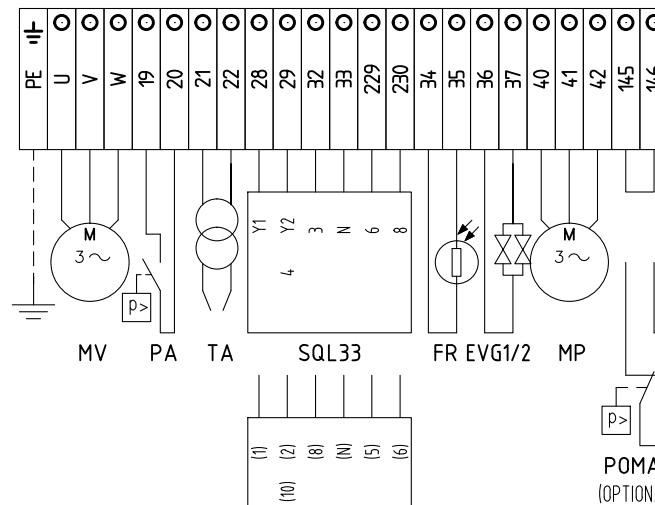

CAMME SERVOCOMANDO
ACTUATOR CAMS
SQL33.03

- Y1 ALTA FIAMMA
HIGH FLAME
- Y2 SOSTA E ACCENSIONE
STAND-BY AND IGNITION
- 3 BASSA FIAMMA
LOW FLAME
- 6 CONSENSO ALLA PARTENZA
INPUT TO START

SERVOCOMANDO SERRANDA ARIA (ALTERNATIVO)
AIR DAMPER ACTUATOR (ALTERNATIVE)
(STM30/24Q15.51/64.3NLP)

- I ALTA FIAMMA
HIGH FLAME
- II SOSTA E ACCENSIONE
STAND-BY AND IGNITION
- III BASSA FIAMMA
LOW FLAME
- V CONSENSO ALLA PARTENZA
INPUT TO START

SERVOCOMANDO SERRANDA ARIA (ALTERNATIVO)
AIR DAMPER ACTUATOR (ALTERNATIVE)
[SQM40.265A]

- I ALTA FIAMMA
HIGH FLAME
- II SOSTA E ACCENSIONE
STAND-BY AND IGNITION
- III BASSA FIAMMA
LOW FLAME
- VI CONSENSO ALLA PARTENZA
INPUT TO START

(STM30/24Q15.51/64.3NLP)

[SQM40.265A]

Data	05/09/2006	PREC.	FOGLIO
Revisione	06	4	5
Dis. N.	07 - 0479	SEGUE	TOTALE
		6	6

Sigla/Item	Foglio/Sheet	Funzione	Function
600V RRR0-1-T73	3	REGOLATORE MODULANTE (ALTERNATIVO)	BURNER MODULATOR (ALTERNATIVE)
(STM30/24.Q15.51/641NLP)	2	SERVOCOMANDO SERRANDA ARIA (ALTERNATIVO)	AIR DAMPER ACTUATOR (ALTERNATIVE)
CMF	3	COMMUT. MANUALE FUNZ. 0)FERMO 1)ALTA FIAMMA 2)BASSA FIAMMA 3)AUTOMATICO	MANUAL SWITCH 0)OFF 1)HIGH FLAME 2)LOW FLAME 3)AUTOMATIC
EVG1/2	2	ELETTROVALVOLE GASOLIO	LIGHT OIL ELECTRO VALVE
FR	2	FOTORESISTENZA RILEVAZIONE FIAMMA	PHOTORESISTOR FLAME DETECTOR
FU	3	FUSIBILE	FUSE
FU1.0	1	FUSIBILI DI LINEA	LINE FUSES
FU1.1	1	FUSIBILI LINEA POMPA	PUMP LINE FUSES
FU1.2	1	FUSIBILE DI LINEA	LINE FUSE
FU1.3	1	FUSIBILE LINEA AUSILIARI	AUXILIARY LINE FUSE
IG	1	INTERRUTTORE GENERALE	MAINS SWITCH
IL	1	INTERRUTTORE LINEA AUSILIARI	AUXILIARY LINE SWITCH
KA2.3	2	RELE' AUSILIARIO	AUXILIARY RELAY
KM1.7	1	CONTATTORE MOTORE VENTILATORE	FAN MOTOR CONTACTOR
KM1.8	1	CONTATTORE MOTORE POMPA GASOLIO	LIGHT OIL PUMP MOTOR CONTACTOR
KM3 HCRMMD	3	REGOLATORE MODULANTE (ALTERNATIVO)	BURNER MODULATOR (ALTERNATIVE)
KT2.4	2	RELE' TEMPORIZZATORE	DELAYED RELAY
LAF	2	LAMPADA SEGNALAZIONE ALTA FIAMMA BRUCIATORE	BURNER IN HIGH FLAME INDICATOR LIGHT
LB	1	LAMPADA SEGNALAZIONE BLOCCO FIAMMA	BURNER LOCK-OUT INDICATOR LIGHT
LBF	2	LAMPADA SEGNALAZIONE BASSA FIAMMA BRUCIATORE	BURNER IN LOW FLAME INDICATOR LIGHT
LEVG	2	LAMPADA SEGNALAZIONE APERTURA [EVG]	INDICATOR LIGHT FOR OPENING OF ELECTRO-VALVE [EVG]
LOA44 / LM024.255 / LM044.255	1	APPARECCHIATURA CONTROLLO FIAMMA	CONTROL BOX
LT	1	LAMPADA SEGNALAZIONE BLOCCO TERMICO MOTORE VENTILATORE	INDICATOR LIGHT FOR FAN MOTOR OVERLOAD THERMAL CUTOUT
LTA	2	LAMPADA SEGNALAZIONE TRASFORMATORE DI ACCENSIONE	IGNITION TRANSFORMER INDICATOR LIGHT
LTP	1	LAMPADA SEGNALAZIONE BLOCCO TERMICO MOTORE POMPA	INDICATOR LIGHT FOR PUMP MOTOR OVERLOAD THERMAL CUTOUT
MP	1	MOTORE POMPA GASOLIO	LIGHT OIL PUMP MOTOR
MV	1	MOTORE VENTILATORE	FAN MOTOR
PA	2	PRESSOSTATO ARIA	AIR PRESSURE SWITCH
POMAX	2	PRESSOSTATO DI MASSIMA PRESSIONE OLIO (OPTIONAL)	MAXIMUM OIL PRESSURE SWITCH (OPTIONAL)
PS	1	PULSANTE SBLOCCO FIAMMA	FLAME UNLOCK BUTTON
PT100	4	SONDA DI TEMPERATURA	TEMPERATURE PROBE
RWF50.2x	3	REGOLATORE MODULANTE	BURNER MODULATOR
RWF55.5x	3	REGOLATORE MODULANTE (ALTERNATIVO)	BURNER MODULATOR (ALTERNATIVE)
SD-PRESS	4	SONDA DI PRESSIONE	PRESSURE PROBE
SD-TEMP.	4	SONDA DI TEMPERATURA	TEMPERATURE PROBE
SD - 0÷10V	4	TRASDUTTORE USCITA IN TENSIONE	TRANSDUCER VOLTAGE OUTPUT
SD - 4÷20mA	4	TRASDUTTORE USCITA IN CORRENTE	TRANSDUCER CURRENT OUTPUT
SQL33.03	2	SERVOCOMANDO SERRANDA ARIA	AIR DAMPER ACTUATOR
ST	1	SERIE TERMOSTATI/PRESSOSTATI	SERIES OF THERMOSTATS OR PRESSURE SWITCHES
TA	2	TRASFORMATORE DI ACCENSIONE	IGNITION TRANSFORMER
TC	4	TERMOCOPPIA	THERMOCOUPLE
TP	1	TERMICO MOTORE POMPA GASOLIO	LIGHT OIL PUMP MOTOR THERMAL
TV	1	TERMICO MOTORE VENTILATORE	FAN MOTOR THERMAL
[SQM40.265A]	2	SERVOCOMANDO SERRANDA ARIA (ALTERNATIVO)	AIR DAMPER ACTUATOR (ALTERNATIVE)

Data	05/09/2006	PREC.	FOGLIO
Revisione	06	5	6
Dis. N.	07 - 0479	SEGUE	TOTALE
		/	6