

BARRA DI TERRA  
EARTH TERMINAL

(S)  
CON LGB22.330 E SQN72.xA4xx COLLEGARE L'ACCESSORIO SIEMENS AGK25 AI MORSETTI 3 E 2 DI LGB  
WITH LGB 22.330 AND SQN72.xA4xx CONNECT THE ACCESSORY SIEMENS AGK25 TO TERMINALS 3 AND 2 OF LGB

Data	19/06/2006	PREC.	FOGLIO
Revisione	04	7	1
Dis. N.	05 - 0785	SEGUE	TOTALE
		2	7

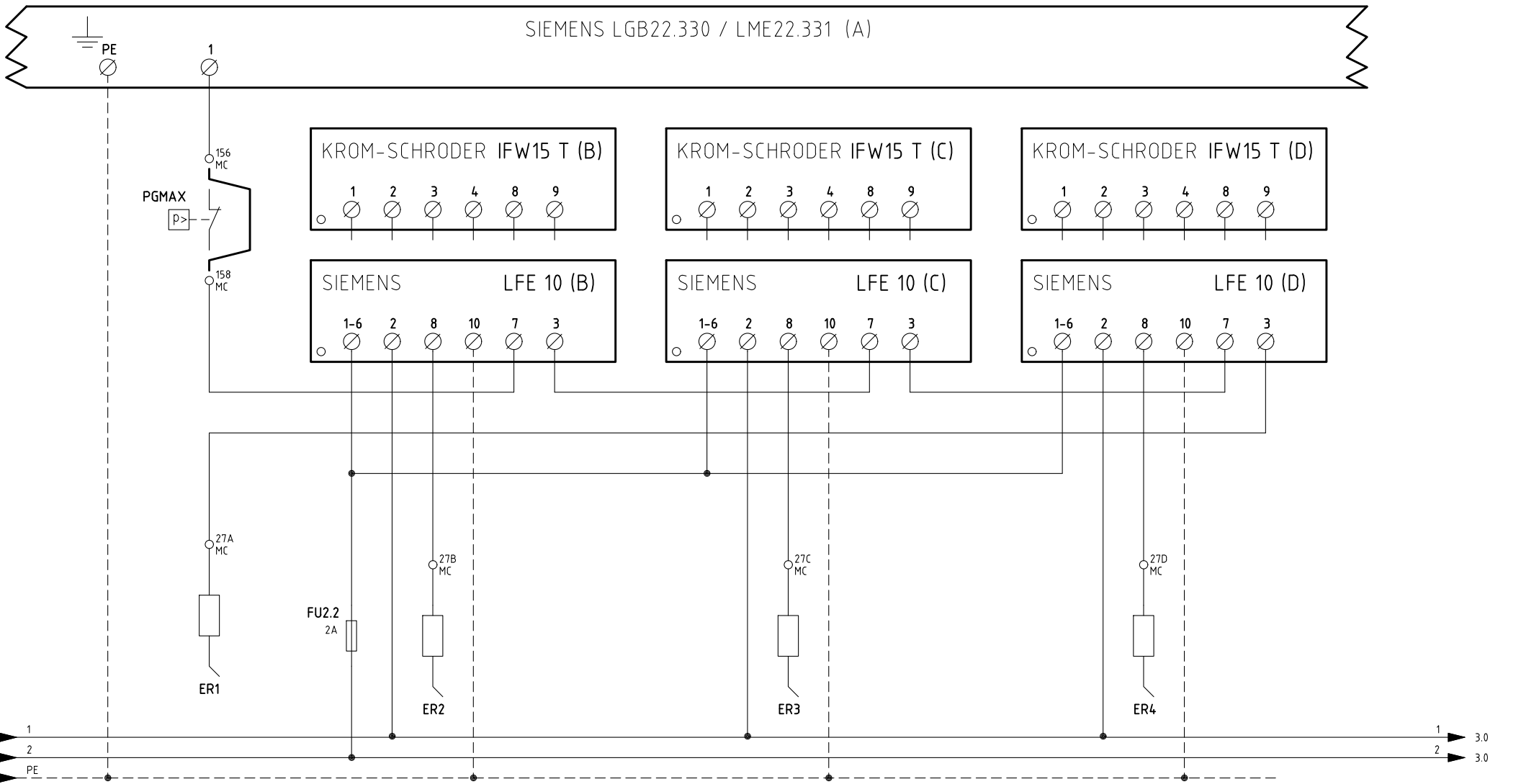

Data	19/06/2006	PREC.	FOGLIO
Revisione	<b>04</b>	<b>1</b>	<b>2</b>
Dis. N.	<b>05 - 0785</b>	SEGUE	TOTALE
		<b>3</b>	<b>7</b>

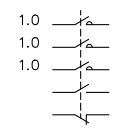
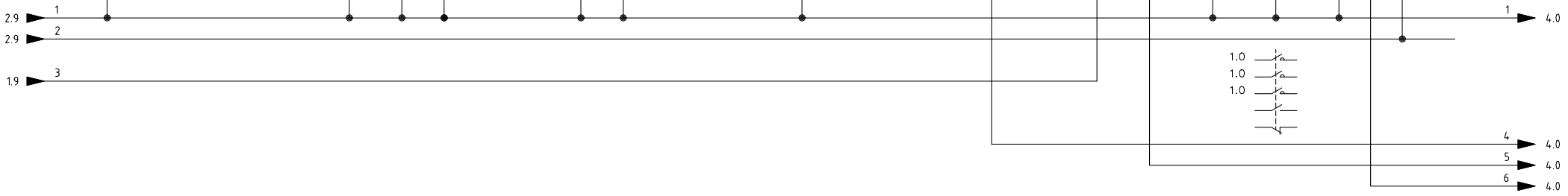
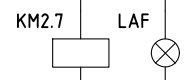
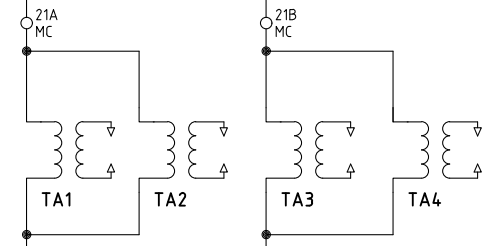
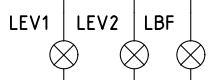
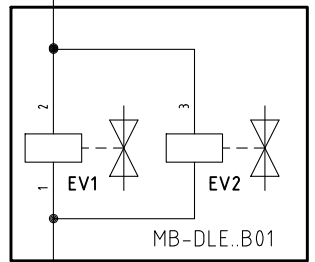
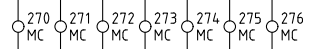
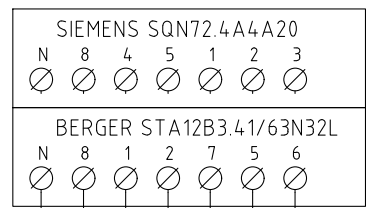
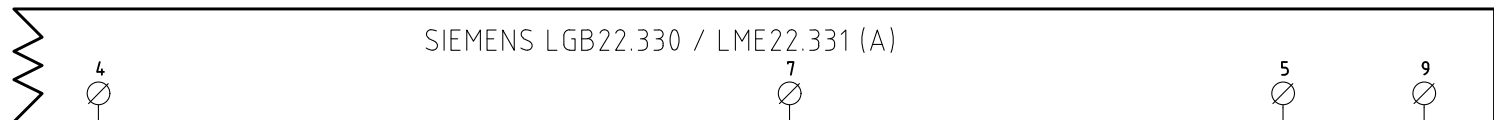

Data	19/06/2006	PREC.	FOGLIO
Revisione	04	2	3
Dis. N.	05 - 0785	SEGUE	TOTALE
		4	7

CMF :  
 1 - ALTA FIAMMA  
 HIGH FLAME  
 2 - BASSA FIAMMA  
 LOW FLAME  
 3 - AUTOMATICO  
 AUTOMATIC  
 4 - AUMENTO LENTO  
 SLOW INCREASE

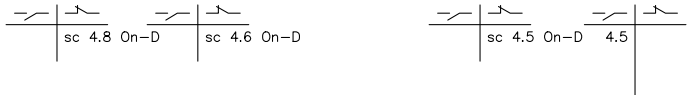
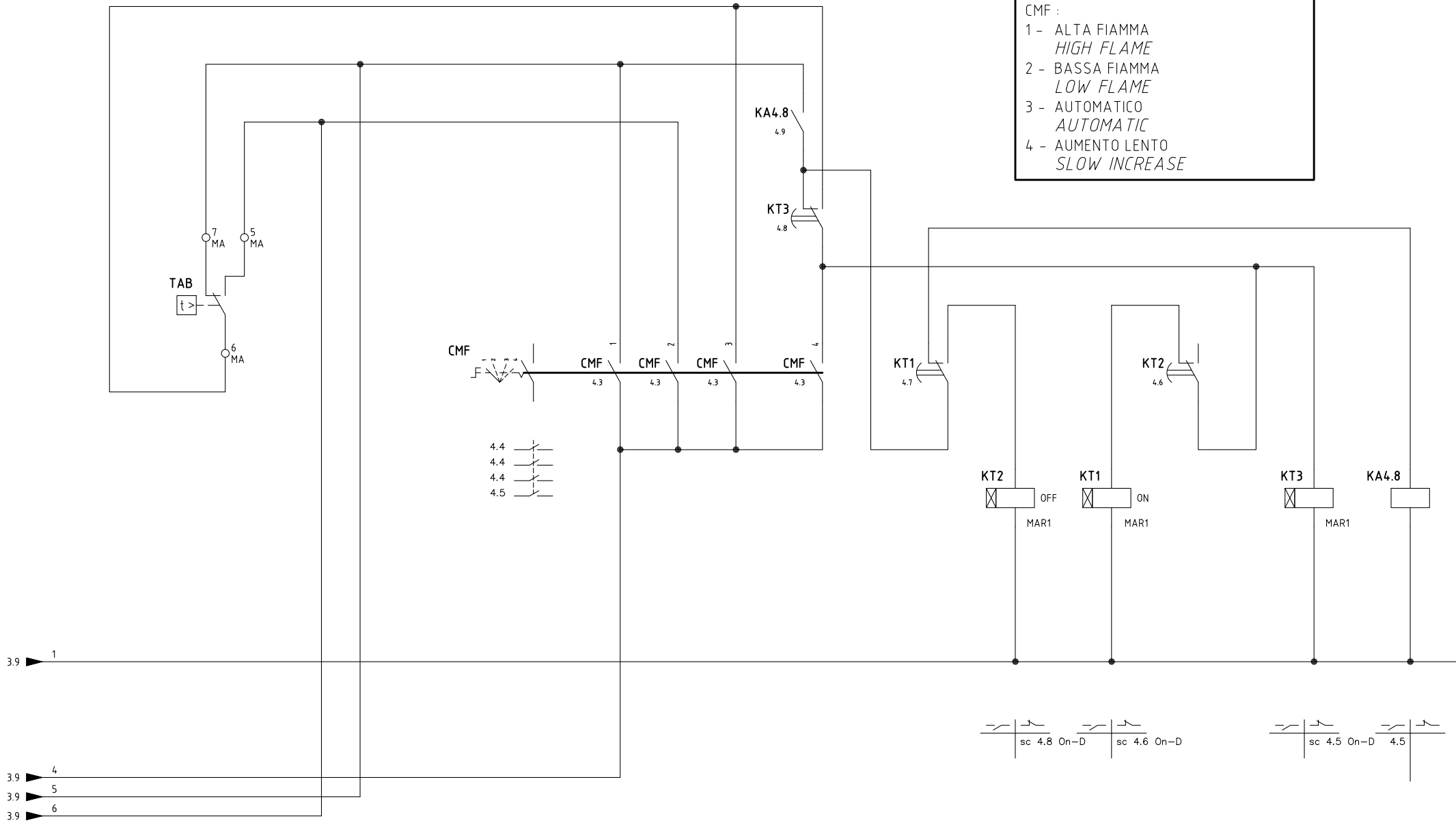

Data	19/06/2006	PREC.	FOGLIO
Revisione	04	3	4
Dis. N.	05 - 0785	SEGUE	TOTALE
		5	7

**QG - MA**  
MORSETTIERA ALIMENTAZIONE  
SUPPLY TERMINAL BOARD

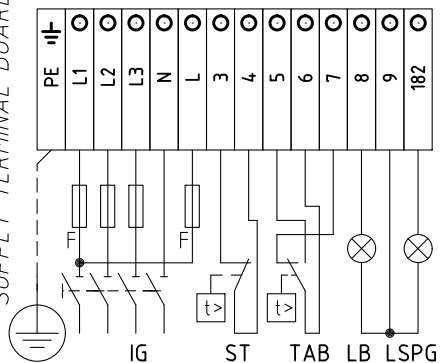

SERVOCOMANDO SERRANDA ARIA  
AIR DAMPER ACTUATOR  
BERGER STA12B3.41/63N32L

ST2 ALTA FIAMMA  
HIGH FLAME  
ST0 SOSTA  
STAND-BY  
ST1 BASSA FIAMMA E ACCENSIONE  
МАЛОЕ ПЛАМЯ И РОЗЖИГ

SERVOCOMANDO SERRANDA ARIA (ALTERNATIVO)  
AIR DAMPER ACTUATOR (ALTERNATIVE)  
SIEMENS SQN72.4A4.A20

I ALTA FIAMMA  
HIGH FLAME  
II SOSTA  
STAND-BY  
III BASSA FIAMMA  
LOW FLAME  
IV NON USATA  
NOT USED

**QG - MC**  
MORSETTIERA COMPONENTI BRUCIATORE  
BURNER COMPONENT TERMINAL BOARD

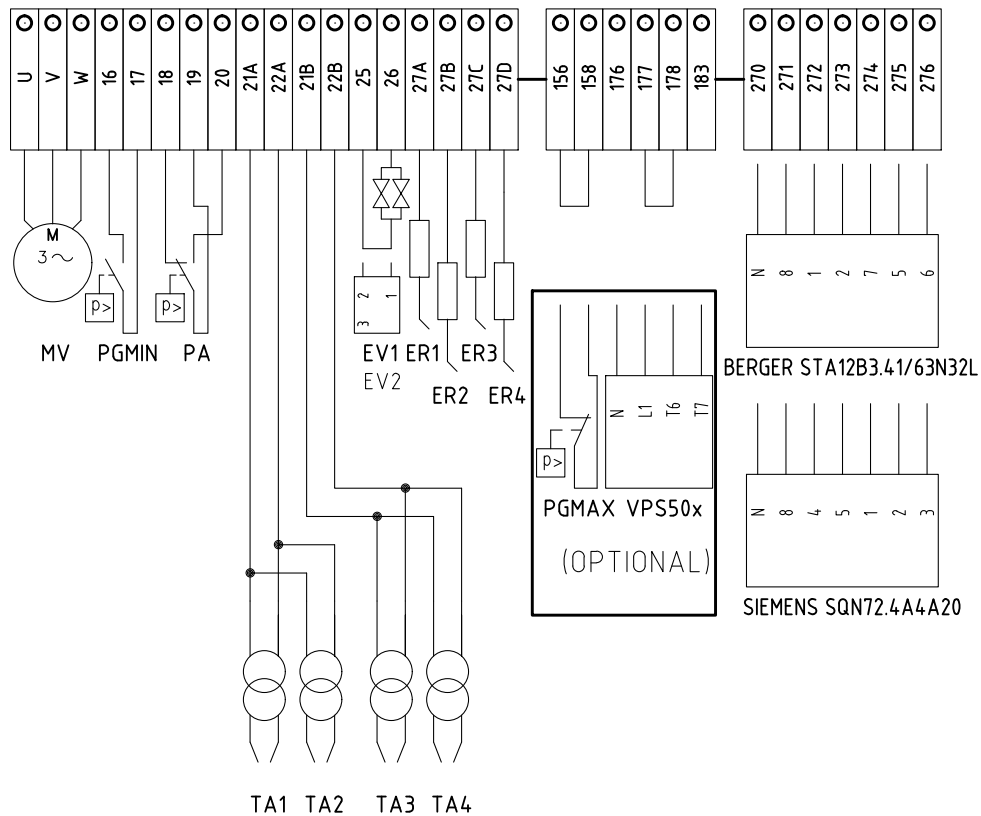

Data	19/06/2006	PREC.	FOGLIO
Revisione	04	4	5
Dis. N.	05 - 0785	SEGUE	TOTALE
		6	7

Sigla/Item	Foglio/Sheet	Funzione	Function
AGK25	1	CARICO RESISTIVO PTC	PTC RESISTIVE LOAD
BERGER STA12B3.41/63N32L	3	SERVOCOMANDO SERRANDA ARIA	AIR DAMPER ACTUATOR
CMF	4	COMMUT. MANUALE FUNZ. 0)FERMO 1)ALTA FIAMMA 2)BASSA FIAMMA 3)AUTOMATICO 4)AVVIAMENTO LENTO	MANUAL SWITCH 0)OFF 1)HIGH FLAME 2)LOW FLAME 3)AUTOMATIC 4) SLOW INCREASE
ER1	2	ELETTRODO RILEVAZIONE FIAMMA	FLAME DETECTION ELECTRODE
ER2	2	ELETTRODO RILEVAZIONE FIAMMA	FLAME DETECTION ELECTRODE
ER3	2	ELETTRODO RILEVAZIONE FIAMMA	FLAME DETECTION ELECTRODE
ER4	2	ELETTRODO RILEVAZIONE FIAMMA	FLAME DETECTION ELECTRODE
EV1	3	ELETTROVALVOLA GAS LATO RETE (O GRUPPO VALVOLE)	UPSTREAM GAS SOLENOID VALVE (OR VALVES GROUP)
EV2	3	ELETTROVALVOLA GAS LATO BRUCIATORE (O GRUPPO VALVOLE)	DOWNSTREAM GAS SOLENOID VALVE (OR VALVES GROUP)
FU1.0	1	FUSIBILI DI LINEA	LINE FUSES
FU1.1	1	FUSIBILE LINEA AUSILIARI	AUXILIARY LINE FUSE
FU1.2	1	FUSIBILE LINEA AUSILIARI	AUXILIARY LINE FUSE
FU2.2	2	FUSIBILE AUSILIARIO	AUXILIARY FUSE
IFW15 T (B)	2	RELE' RILEVAZIONE FIAMMA	FLAME DETECTOR RELAY
IFW15 T (C)	2	RELE' RILEVAZIONE FIAMMA	FLAME DETECTOR RELAY
IFW15 T (D)	2	RELE' RILEVAZIONE FIAMMA	FLAME DETECTOR RELAY
IG	1	INTERRUTTORE GENERALE	MAIN SWITCH
IL	1	INTERRUTTORE LINEA AUSILIARI	AUXILIARY LINE SWITCH
KA4.8	4	RELE' AUSILIARIO	AUXILIARY RELAY
KM2.7	3	CONTATTORE MOTORE VENTILATORE	FAN MOTOR CONTACTOR
KT1	4	RELE' TEMPORIZZATORE ON	DELAYED RELAY ON
KT2	4	RELE' TEMPORIZZATORE OFF	DELAYED RELAY OFF
KT3	4	RELE' TEMPORIZZATORE MODULAZIONE	MODULATION DELAYED RELAY
LAF	3	LAMPADA SEGNALAZIONE ALTA FIAMMA BRUCIATORE	BURNER IN HIGH FLAME INDICATOR LIGHT
LB	1	LAMPADA SEGNALAZIONE BLOCCO BRUCIATORE	INDICATOR LIGHT FOR BURNER LOCK-OUT
LBF	3	LAMPADA SEGNALAZIONE BASSA FIAMMA BRUCIATORE	BURNER IN LOW FLAME INDICATOR LIGHT
LEV1	3	LAMPADA SEGNALAZIONE APERTURA [EV1]	INDICATOR LIGHT FOR OPENING OF ELECTRO-VALVE [EV1]
LEV2	3	LAMPADA SEGNALAZIONE APERTURA [EV2]	INDICATOR LIGHT FOR OPENING OF ELECTRO-VALVE [EV2]
LFE 10 (B)	2	RELE' RILEVAZIONE FIAMMA (ALTERNATIVA)	FLAME DETECTOR RELAY (ALTERNATIVE)
LFE 10 (C)	2	RELE' RILEVAZIONE FIAMMA (ALTERNATIVA)	FLAME DETECTOR RELAY (ALTERNATIVE)
LFE 10 (D)	2	RELE' RILEVAZIONE FIAMMA (ALTERNATIVA)	FLAME DETECTOR RELAY (ALTERNATIVE)
LGB22.330 / LME22.331 (A)	1	APPARECCHIATURA CONTROLLO FIAMMA	CONTROL BOX

Data	19/06/2006	PREC.	FOGLIO
Revisione	<b>04</b>	<b>5</b>	<b>6</b>
Dis. N.	<b>05 - 0785</b>	SEGUE	TOTALE
		<b>7</b>	<b>7</b>

Sigla/Item	Foglio/Sheet	Funzione	Function
LPGMIN	1	LAMPADA SEGNALAZIONE PRESENZA GAS IN RETE	INDICATOR LIGHT FOR PRESENCE OF GAS IN THE NETWORK
LSPG	1	LAMPADA SEGNALAZIONE BLOCCO CONTROLLO TENUTA VALVOLE	INDICATOR LIGHT FOR LEAKAGE OF VALVES
LT	1	LAMPADA SEGNALAZIONE BLOCCO TERMICO MOTORE VENTILATORE	INDICATOR LIGHT FOR FAN MOTOR OVERLOAD THERMAL CUTOUT
LTA	3	LAMPADA SEGNALAZIONE TRASFORMATORE DI ACCENSIONE	IGNITION TRANSFORMER INDICATOR LIGHT
MV	1	MOTORE VENTILATORE	FAN MOTOR
PA	1	PRESSOSTATO ARIA	AIR PRESSURE SWITCH
PGMAX	2	PRESSOSTATO GAS DI MASSIMA PRESSIONE (OPTIONAL)	MAXIMUM PRESSURE GAS SWITCH (OPTIONAL)
PGMIN	1	PRESSOSTATO GAS DI MINIMA PRESSIONE	MINIMUM GAS PRESSURE SWITCH
PS	1	PULSANTE SBLOCCO FIAMMA	FLAME UNLOCK BUTTON
SIEMENS SQN72.4A4A20	3	SERVOCOMANDO SERRANDA ARIA (ALTERNATIVO)	AIR DAMPER ACTUATOR (ALTERNATIVE)
ST	1	SERIE TERMOSTATI/PRESSOSTATI	SERIES OF THERMOSTATS OR PRESSURE SWITCHES
TA1	3	TRASFORMATORE DI ACCENSIONE	IGNITION TRANSFORMER
TA2	3	TRASFORMATORE DI ACCENSIONE	IGNITION TRANSFORMER
TA3	3	TRASFORMATORE DI ACCENSIONE	IGNITION TRANSFORMER
TA4	3	TRASFORMATORE DI ACCENSIONE	IGNITION TRANSFORMER
TAB	4	TERMOSTATO/PRESSOSTATO ALTA-BASSA FIAMMA	HIGH-LOW THERMOSTAT/PRESSURE SWITCHES
TV	1	TERMICO MOTORE VENTILATORE	FAN MOTOR THERMAL
VPS50x	1	CONTROLLO DI TENUTA VALVOLE GAS (OPTIONAL)	GAS PROVING SYSTEM (OPTIONAL)

Data	19/06/2006	PREC.	FOGLIO
Revisione	<b>04</b>	<b>6</b>	<b>7</b>
Dis. N.	<b>05 - 0785</b>	SEGUE	TOTALE
		/	<b>7</b>