

(x)
INSTALLATO SOLO SU ALCUNE VERSIONI
INSTALLED ON ANY VERSIONS ONLY

01	RELAY "KTRS" MODIFIED	02/11/17	U. PINTON
REV.	MODIFICA	DATA	FIRME



Impianto

TIPO/TYPE RN510
MODELLO/MODEL x-.MD.S.xx.A

Descrizione

VERSIONE CON MULTI-TERMOSTATO MCX06C
VERSION WITH MCX06C MULTI-THERMOSTAT

Ordine	
Commessa	Data Controllato 02/11/2017
Esecutore U. PINTON	Controllato M. MASCHIO

Data	29/02/2016	PREC.	FOGLIO
Revisione	01	/	1
Dis. N.	11 - 0501	SEGUE	TOTALE
		2	9

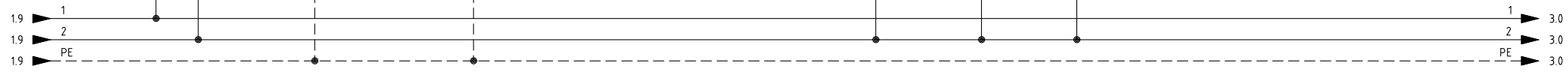
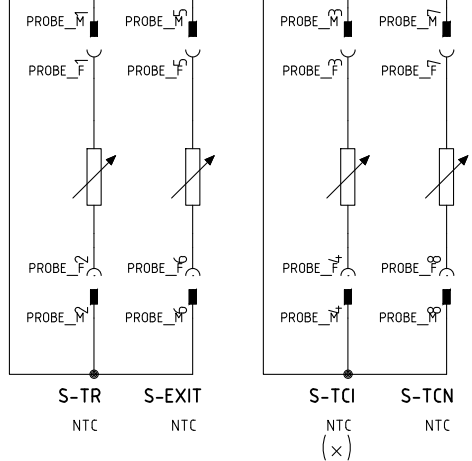
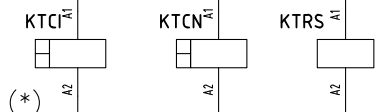
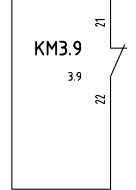
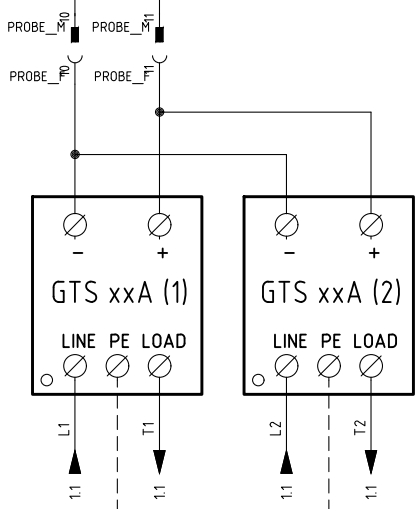
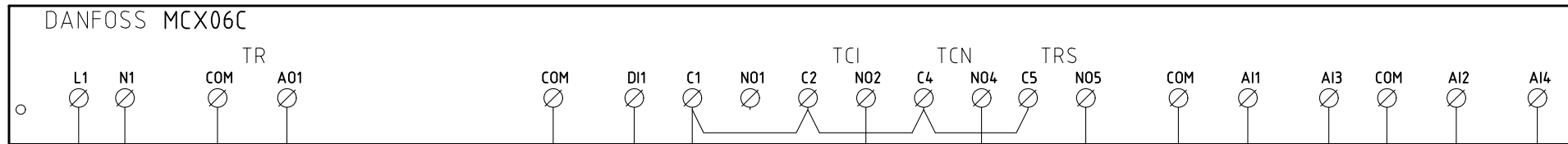

(x)
 INSTALLATO SOLO SU ALCUNE VERSIONI
 INSTALLED ON ANY VERSIONS ONLY

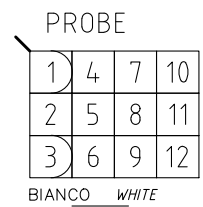
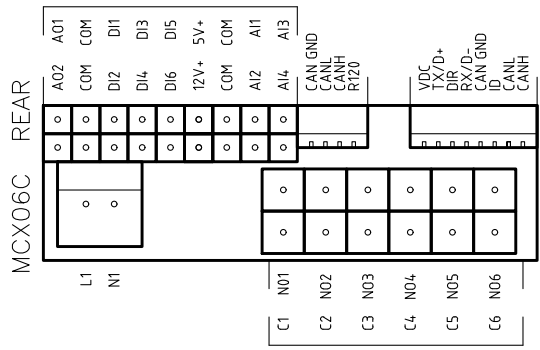

VISTA LATO COMPONENTI (SONDE)
 COMPONENTS SIDE VIEW (PROBE)

BIANCO WHITE

Data	29/02/2016	PREC.	FOGLIO
Revisione	01	1	2
Dis. N.	11 - 0501	SEGUE	TOTALE
		3	9

SIEMENS LAL 2.25

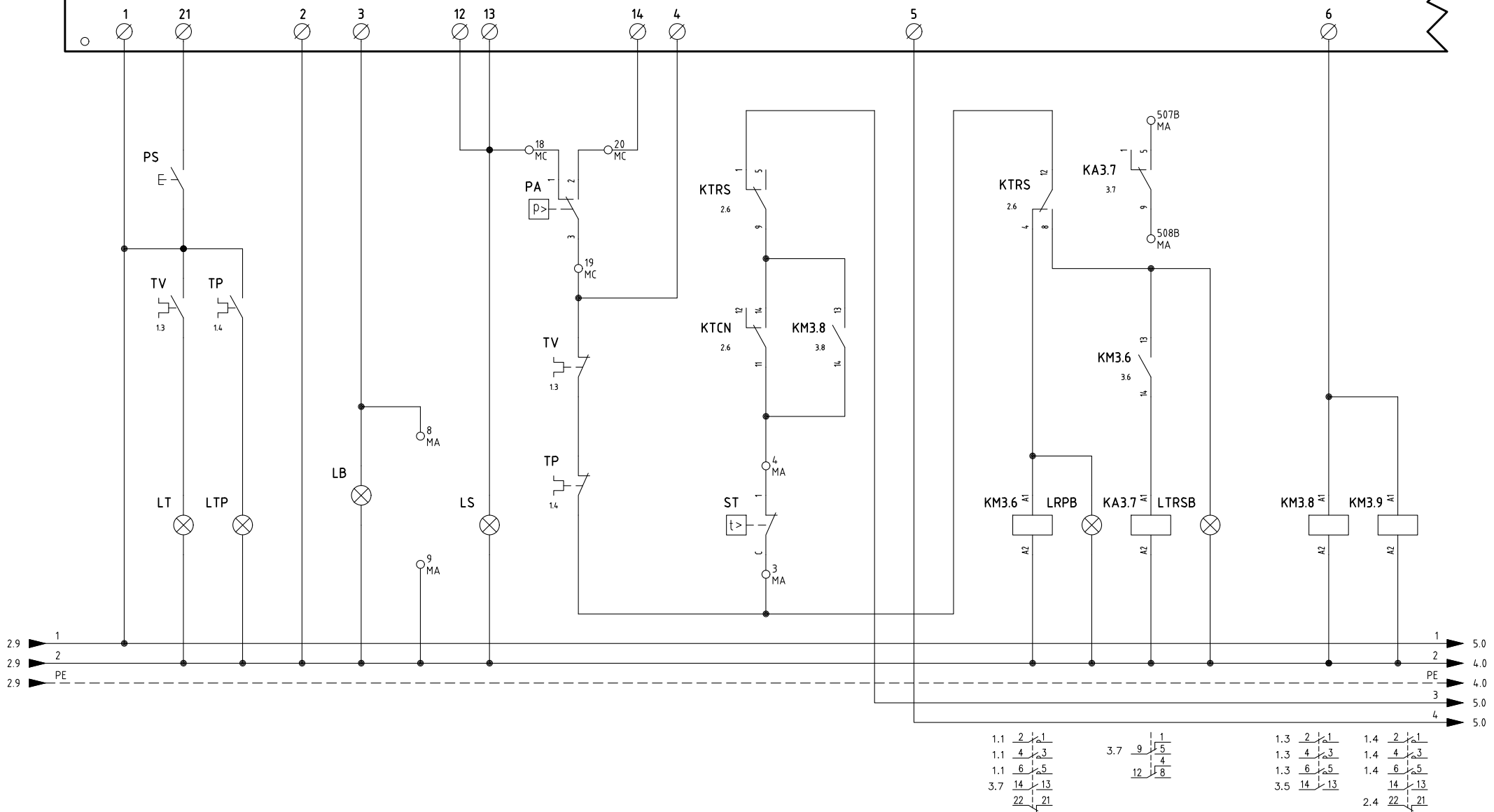

Data	29/02/2016	PREC.	FOGLIO
Revisione	01	2	3
Dis. N.	11 - 0501	SEGUE	TOTALE
		4	9

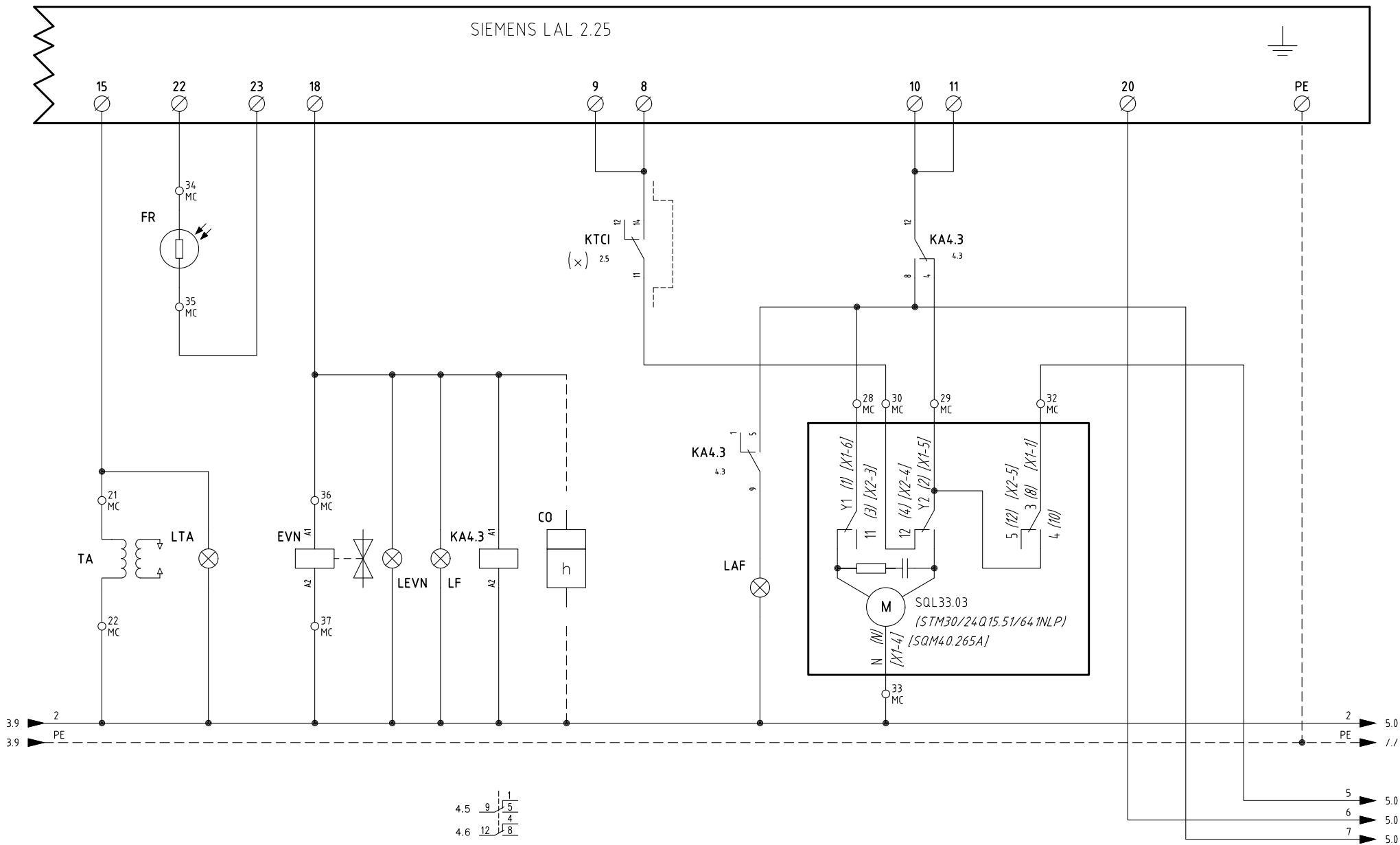

(x)
 INSTALLATO SOLO SU ALCUNE VERSIONI
 INSTALLED ON ANY VERSIONS ONLY

Data	29/02/2016	PREC.	FOGLIO
Revisione	01	3	4
Dis. N.	11 - 0501	SEGUE	TOTALE
		5	9

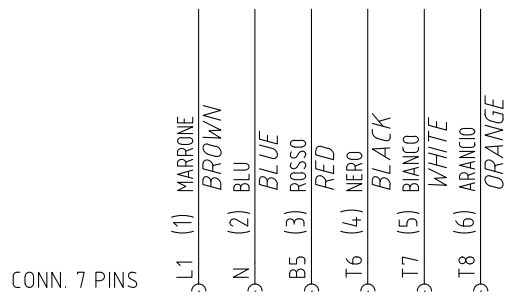
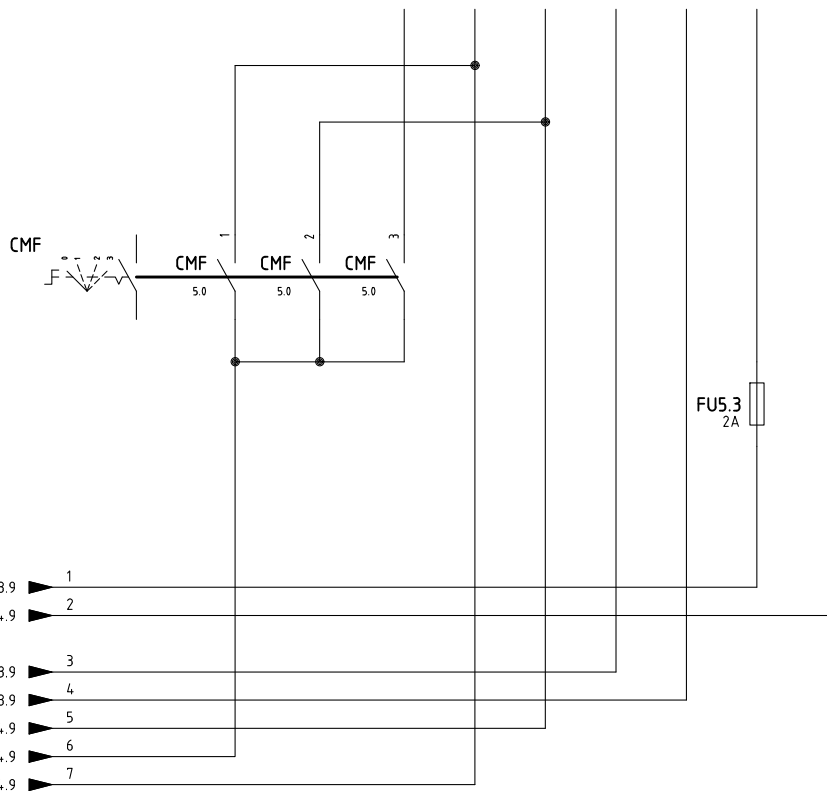
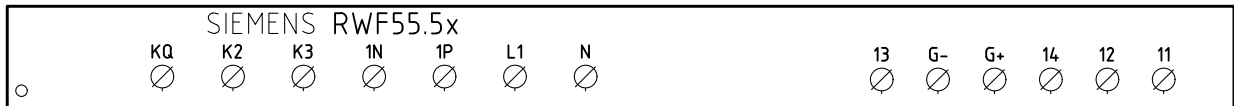
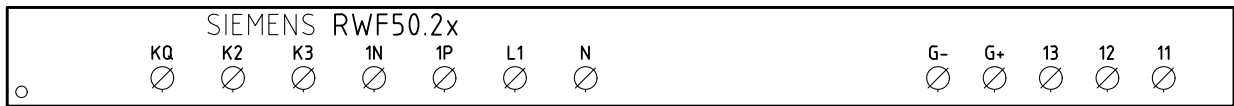
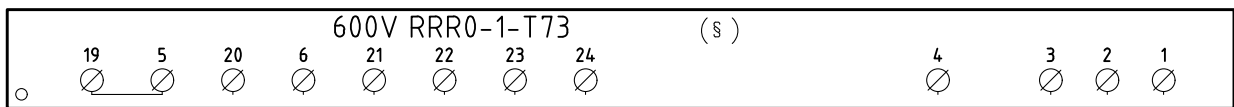
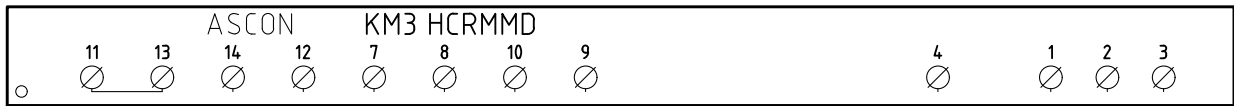

CAVO 7x0,75mmq
7x0,75mmq CABLE

CONN. 7 PINS

(xx)
ATTENZIONE COLLEGAMENTO SONDE CON CONNETTORE 7 POLI
WARNING PROBE CONNECTION WITH 7 PINS CONNECTOR

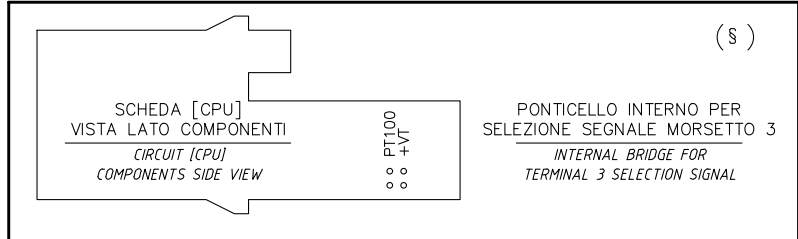

Data	29/02/2016	PREC.	FOGLIO
Revisione	01	4	5
Dis. N.	11 - 0501	SEGUE	TOTALE
		6	9

(xx)

ATTENZIONE COLLEGAMENTO SONDE CON CONNETTORE 7 POLI
 WARNING PROBE CONNECTION WITH 7 PINS CONNECTOR

KM3 HCRMMD

600V RRR0-1-T73

RWF55.5x

RWF50.2x

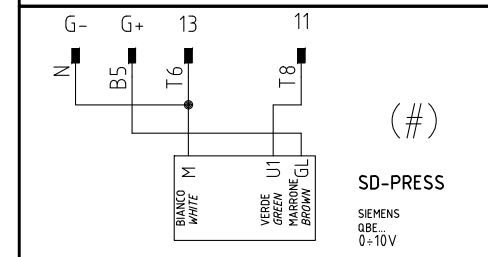
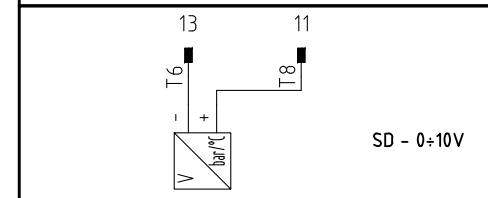
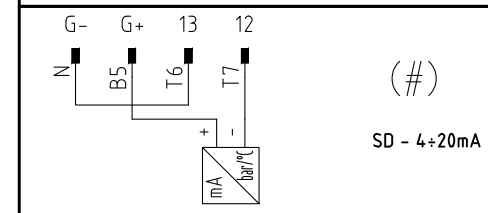
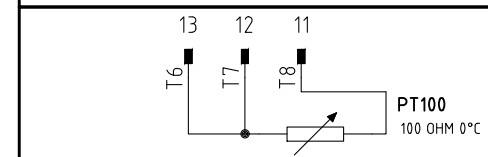
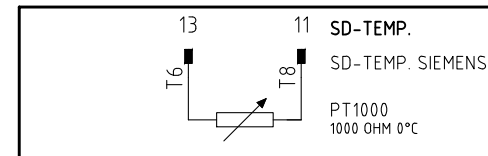
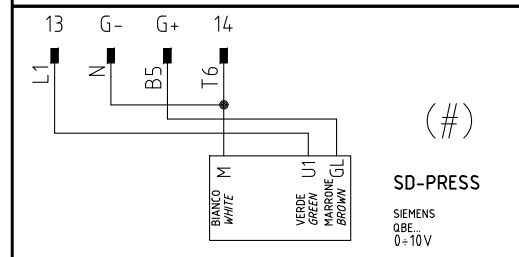
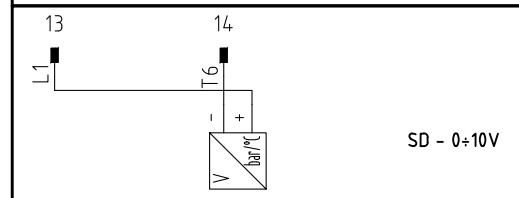
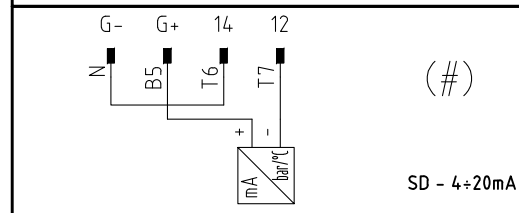
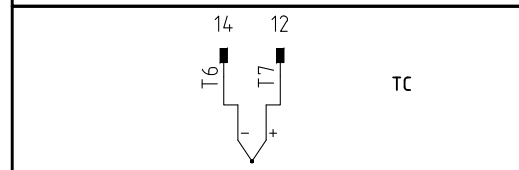
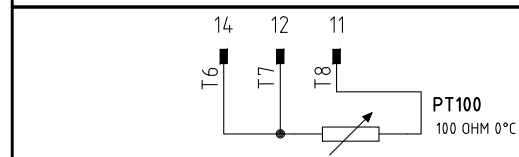
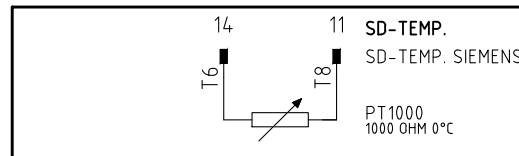
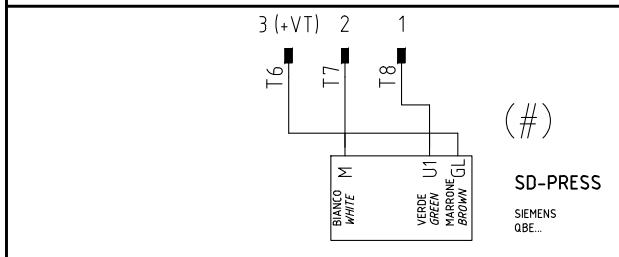
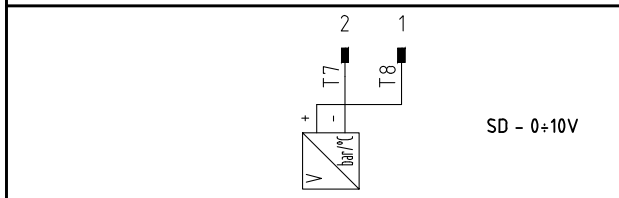
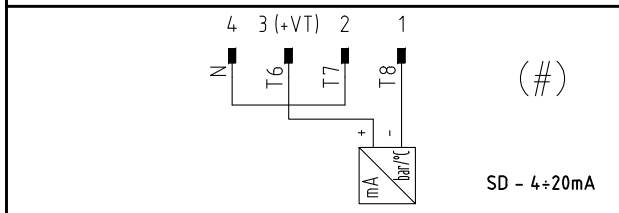
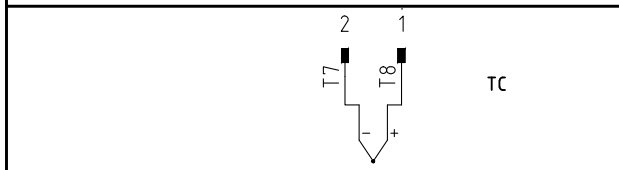
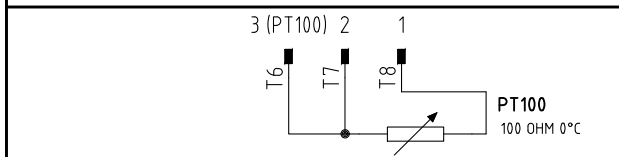
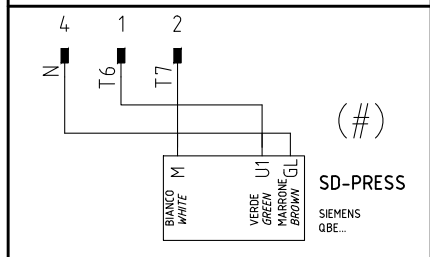
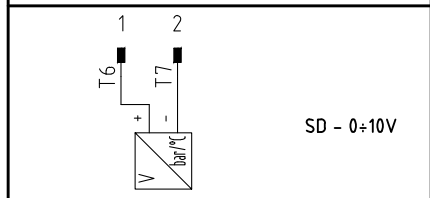
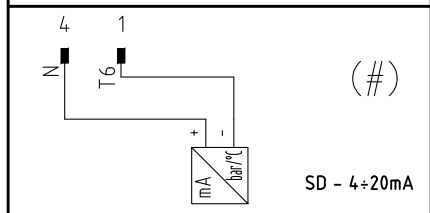
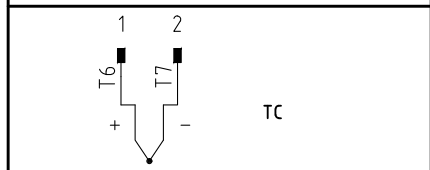
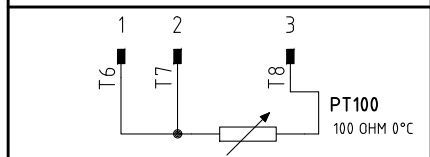
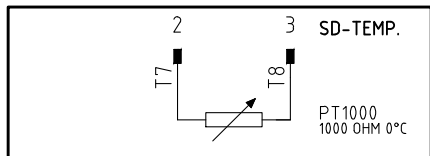

(#)

COLLEGAMENTO SOLO PER
 TRASDUTTORI PASSIVI
 TRANSDUCER PASSIVE
 CONNECTION ONLY

Data	29/02/2016	PREC.	FOGLIO
Revisione	01	5	6
Dis. N.	11 - 0501	SEGUE	TOTALE
		7	9

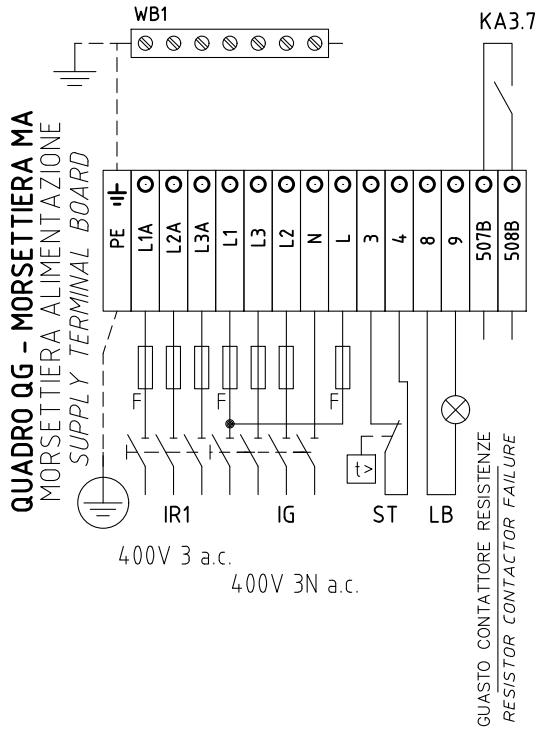

SERVOCOMANDO SERRANDA ARIA
 AIR DAMPER ACTUATOR
 [SQM40.265A]

- I ALTA FIAMMA
HIGH FLAME
- II SOSTA E ACCENSIONE
STAND-BY AND IGNITION
- III BASSA FIAMMA
LOW FLAME

SERVOCOMANDO SERRANDA ARIA (ALTERNATIVO)
 AIR DAMPER ACTUATOR (ALTERNATIVE)
 (STM30/24Q15.51/641NLP)

- I ALTA FIAMMA
HIGH FLAME
- II SOSTA E ACCENSIONE
STAND-BY AND IGNITION
- III BASSA FIAMMA
LOW FLAME

SERVOCOMANDO SERRANDA ARIA (ALTERNATIVO)
 AIR DAMPER ACTUATOR (ALTERNATIVE)
 SQL33.03

- Y1 ALTA FIAMMA
HIGH FLAME
- Y2 SOSTA E ACCENSIONE
STAND-BY AND IGNITION
- 3 BASSA FIAMMA
LOW FLAME

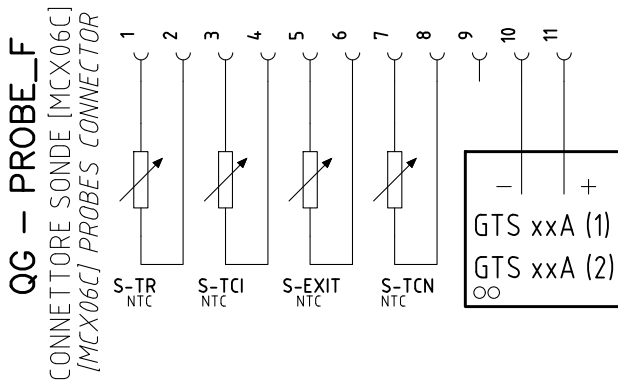

QUADRO QG - MORSETTIERA MC
MORSETTIERA COMPONENTI BRUCIATORE
BURNER COMPONENT TERMINAL BOARD

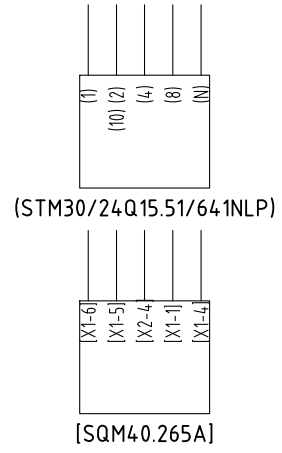
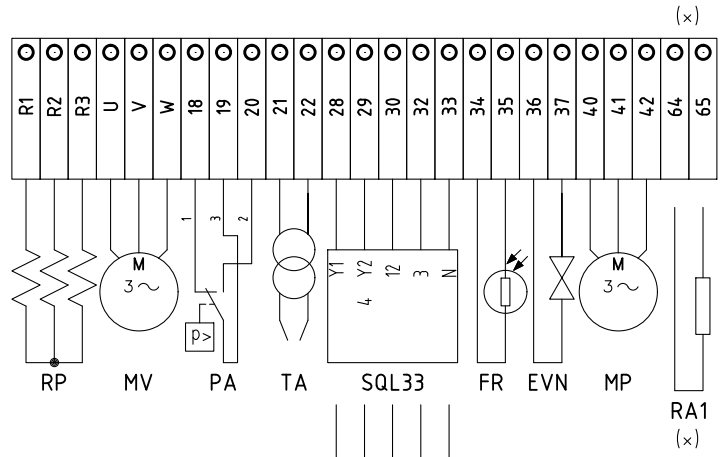

(x)
 INSTALLATO SOLO SU ALCUNE VERSIONI
 INSTALLED ON ANY VERSIONS ONLY

Data	29/02/2016	PREC.	FOGLIO
Revisione	01	6	7
Dis. N.	11 - 0501	SEGUE	TOTALE
		8	9

Sigla/Item	Foglio/Sheet	Funzione	Function
600V RRR0-1-T73	5	REGOLATORE MODULANTE (ALTERNATIVO)	BURNER MODULATOR (ALTERNATIVE)
(STM30/24Q15.51/641NLP)	4	SERVOCOMANDO SERRANDA ARIA (ALTERNATIVO)	AIR DAMPER ACTUATOR (ALTERNATIVE)
CMF	5	COMMUT. MANUALE FUNZ. 0)FERMO 1)ALTA FIAMMA 2)BASSA FIAMMA 3)AUTOMATICO	MANUAL SWITCH 0)OFF 1)HIGH FLAME 2)LOW FLAME 3)AUTOMATIC
CO	4	CONTAORE DI FUNZIONAMENTO (OPTIONAL)	OPERATION TIME COUNTER (OPTIONAL)
EVN	4	ELETTROVALVOLA NAFTA	OIL SOLENOID VALVE
FR	4	FOTORESISTENZA RILEVAZIONE FIAMMA	PHOTORESISTOR FLAME DETECTOR
FU1.1	1	FUSIBILI LINEA PRERISCALDATORE [RPA]	LINE PRE-HEATING [RPA] FUSES
FU1.2	1	FUSIBILI LINEA MOTORE VENTILATORE	FAN MOTOR LINE FUSES
FU1.4	1	FUSIBILI LINEA POMPA	PUMP LINE FUSES
(x) FU1.6	1	FUSIBILE RESISTENZE AUSILIARIE	AUXILIARY HEATERS FUSE
FU1.8	1	FUSIBILE LINEA AUSILIARI	AUXILIARY LINE FUSE
FU2.0	2	FUSIBILE AUSILIARIO	AUXILIARY FUSE
FU2.1	2	FUSIBILE AUSILIARIO	AUXILIARY FUSE
FU5.3	5	FUSIBILE	FUSE
GTS xxA (1)	2	TIRISTORE	THYRISTOR
GTS xxA (2)	2	TIRISTORE	THYRISTOR
IB	1	INTERRUTTORE LINEA BRUCIATORE	BURNER LINE SWITCH
IL	1	INTERRUTTORE LINEA AUSILIARI	AUXILIARY LINE SWITCH
(x) IR1	1	INTERRUTTORE LINEA RESISTENZE PRERISCALDATORE [RPA]	PRE-HEATING RESISTOR [RPA] LINE SWITCH
IRA	1	INTERRUTTORE RESISTENZE AUSILIARIE	AUXILIARY HEATERS SWITCH
KA3.7	3	RELE" AUSILIARIO SEGNALAZIONE GUASTO CONTATTORE RESISTENZE	AUXILIARY RELAY FOR RESISTOR CONTACTOR FAILURE
KA4.3	4	RELE" AUSILIARIO	AUXILIARY RELAY
KM3.6	3	CONTATTORE RESISTENZE PRERISCALDATORE [RPB]	PRE-HEATING RESISTOR [RPB] CONTACTOR
KM3.8	3	CONTATTORE MOTORE VENTILATORE	FAN MOTOR CONTACTOR
KM3.9	3	CONTATTORE MOTORE POMPA NAFTA	OIL PUMP MOTOR CONTACTOR
KM3 HCRMMD	5	REGOLATORE MODULANTE (ALTERNATIVO)	BURNER MODULATOR (ALTERNATIVE)
(x) KTCI	2	RELE" AUSILIARIO	AUXILIARY RELAY
KTCN	2	RELE" AUSILIARIO	AUXILIARY RELAY
KTRS	2	RELE" AUSILIARIO	AUXILIARY RELAY
LAF	4	LAMPADA SEGNALAZIONE ALTA FIAMMA BRUCIATORE	BURNER IN HIGH FLAME INDICATOR LIGHT
LAL 2.25	3	APPARECCHIATURA CONTROLLO FIAMMA	CONTROL BOX
LB	3	LAMPADA SEGNALAZIONE BLOCCO BRUCIATORE	INDICATOR LIGHT FOR BURNER LOCK-OUT
LEVN	4	LAMPADA SEGNALAZIONE APERTURA [EVN]	INDICATOR LIGHT FOR OPENING OF ELECTRO-VALVE [EVN]
LF	4	LAMPADA SEGNALAZIONE BASSA FIAMMA BRUCIATORE	BURNER IN LOW FLAME INDICATOR LIGHT

(x)
 INSTALLATO SOLO SU ALCUNE VERSIONI
 INSTALLED ON ANY VERSIONS ONLY

Data	29/02/2016	PREC.	FOGLIO
Revisione	01	7	8
Dis. N.	11 - 0501	SEGUE	TOTALE
		9	9

Sigla/Item	Foglio/Sheet	Funzione	Function
LRPB	3	LAMPADA SEGNALAZIONE FUNZIONAMENTO PRERISCALDATORE [RPB]	INDICATOR LIGHT FOR PRE-HEATING RESISTOR [RPB] OPERATION
LS	3	LAMPADA SEGNALAZIONE SOSTA BRUCIATORE	INDICATOR LIGHT FOR BURNER STAND-BY
LT	3	LAMPADA SEGNALAZIONE BLOCCO TERMICO	INDICATOR LIGHT FOR MOTOR OVERLOAD THERMAL CUTOUT
LTA	4	LAMPADA SEGNALAZIONE TRASFORMATORE DI ACCENSIONE	IGNITION TRANSFORMER INDICATOR LIGHT
LTP	3	LAMPADA SEGNALAZIONE BLOCCO TERMICO MOTORE POMPA	INDICATOR LIGHT FOR PUMP MOTOR OVERLOAD THERMAL CUTOUT
LTRSB	3	LAMPADA SEGNALAZIONE BLOCCO TERMOSTATO DI SICUREZZA [TRSB]	INDICATOR LIGHT FOR [TRSB] SAFETY THERMOSTAT
MCX06C	2	REGOLATORE TEMPERATURE NAFTA	OIL TEMPERATURE REGULATOR
MP	1	MOTORE POMPA NAFTA	OIL PUMP MOTOR
MV	1	MOTORE VENTILATORE	FAN MOTOR
PA	3	PRESSOSTATO ARIA	AIR PRESSURE SWITCH
PS	3	PULSANTE SBLOCCO FIAMMA	FLAME UNLOCK BUTTON
PT100	6	SONDA DI TEMPERATURA	TEMPERATURE PROBE
(x) RA	1	RESISTENZE AUSILIARIE	AUXILIARY HEATERS
RP	1	RESISTENZE PRERISCALDATORE NAFTA	PRE-HEATING TANK RESISTORS
RWF50.2x	5	REGOLATORE MODULANTE	BURNER MODULATOR
RWF55.5x	5	REGOLATORE MODULANTE (ALTERNATIVO)	BURNER MODULATOR (ALTERNATIVE)
(x) S-EXIT	2	SONDA TEMPERATURA USCITA BARILOTTO	TANK OUTLET OIL TEMPERATURE PROBE
(x) S-TCI	2	SONDA TEMPERATURA CONSENSO IMPIANTO	PLANT CONSENT TEMPERATURE PROBE
S-TCN	2	SONDA TEMPERATURA CONSENSO NAFTA	OIL CONSENT TEMPERATURE PROBE
S-TR	2	SONDA TEMPERATURA RESISTENZE	RESISTOR TEMPERATURE PROBE
SD-PRESS	6	SONDA DI PRESSIONE	PRESSURE PROBE
SD-TEMP.	6	SONDA DI TEMPERATURA	TEMPERATURE PROBE
SD - 0÷10V	6	TRASDUTTORE USCITA IN TENSIONE	TRANSDUCER VOLTAGE OUTPUT
SD - 4÷20mA	6	TRASDUTTORE USCITA IN CORRENTE	TRANSDUCER CURRENT OUTPUT
SQL33.03	4	SERVOCOMANDO SERRANDA ARIA	AIR DAMPER ACTUATOR
ST	3	SERIE TERMOSTATI/PRESSOSTATI	SERIES OF THERMOSTATS OR PRESSURE SWITCHES
TA	4	TRASFORMATORE DI ACCENSIONE	IGNITION TRANSFORMER
TC	6	TERMOCOPPIA	THERMOCOUPLE
TP	1	TERMICO MOTORE POMPA	PUMP MOTOR THERMAL
TRAFO	2	TRASFORMATORE AUSILIARIO	AUXILIARY TRANSFORMER
TV	1	TERMICO MOTORE VENTILATORE	FAN MOTOR THERMAL
WB1	1	BARRA DI TERRA	EARTH TERMINAL
[SQM40.265A]	4	SERVOCOMANDO SERRANDA ARIA (ALTERNATIVO)	AIR DAMPER ACTUATOR (ALTERNATIVE)

(x)
 INSTALLATO SOLO SU ALCUNE VERSIONI
 INSTALLED ON ANY VERSIONS ONLY

Data	29/02/2016	PREC.	FOGLIO
Revisione	01	8	9
Dis. N.	11 - 0501	SEGUE	TOTALE
		1	9