

(x)  
 INSTALLATO SOLO SU ALCUNE VERSIONI  
 INSTALLED ON ANY VERSIONS ONLY

|      |                       |          |           |
|------|-----------------------|----------|-----------|
| 01   | RELAY "KTRS" MODIFIED | 02/11/17 | U. PINTON |
| REV. | MODIFICA              | DATA     | FIRME     |



Impianto

TIPO/TYPE RN510  
 MODELLO/MODEL x-.MD.S.xx.A

Descrizione

VERSIONE CON MULTI-TERMOSTATO MCX06C  
 VERSION WITH MCX06C MULTI-THERMOSTAT

|                        |                                |
|------------------------|--------------------------------|
| Ordine                 |                                |
| Commessa               | Data Controllato<br>02/11/2017 |
| Esecutore<br>U. PINTON | Controllato<br>M. MASCHIO      |

|           |            |       |        |
|-----------|------------|-------|--------|
| Data      | 29/02/2016 | PREC. | FOGLIO |
| Revisione | 01         | /     | 1      |
| Dis. N.   | 11 - 0501  | SEGUE | TOTALE |
|           |            | 2     | 9      |

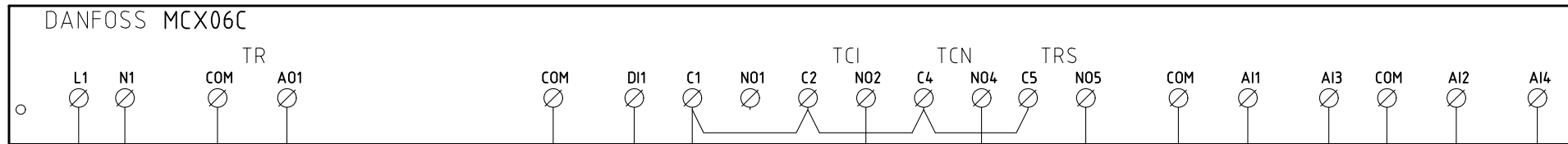

FU2.0  
1A F

TRAFO  
230V AC  
24V AC  
10VA

FU2.1  
1A F

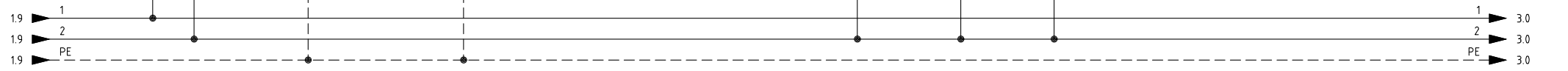
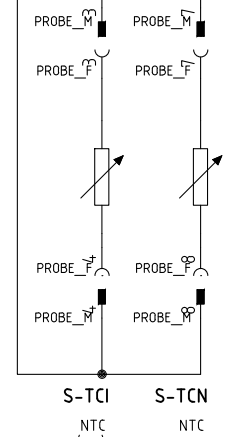
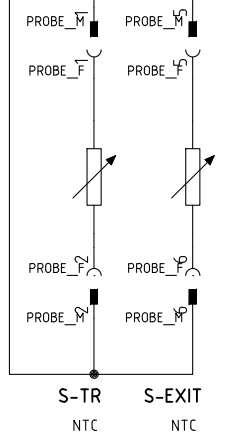
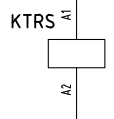
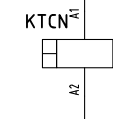
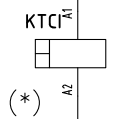
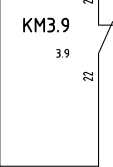
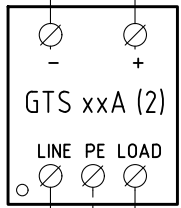
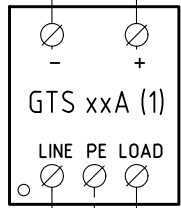

(x)  
INSTALLATO SOLO SU ALCUNE VERSIONI  
INSTALLED ON ANY VERSIONS ONLY

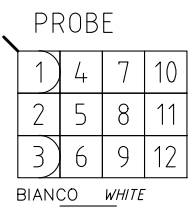
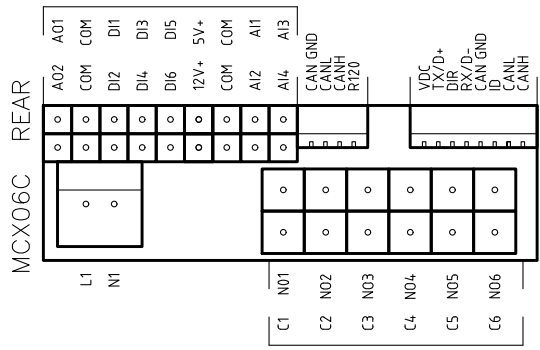

VISTA LATO COMPONENTI (SONDE)  
COMPONENTS SIDE VIEW (PROBE)

BIANCO WHITE

|           |            |       |        |
|-----------|------------|-------|--------|
| Data      | 29/02/2016 | PREC. | FOGLIO |
| Revisione | 01         | 1     | 2      |
| Dis. N.   | 11 - 0501  | SEGUE | TOTALE |
|           |            | 3     | 9      |

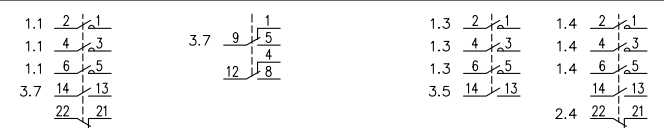
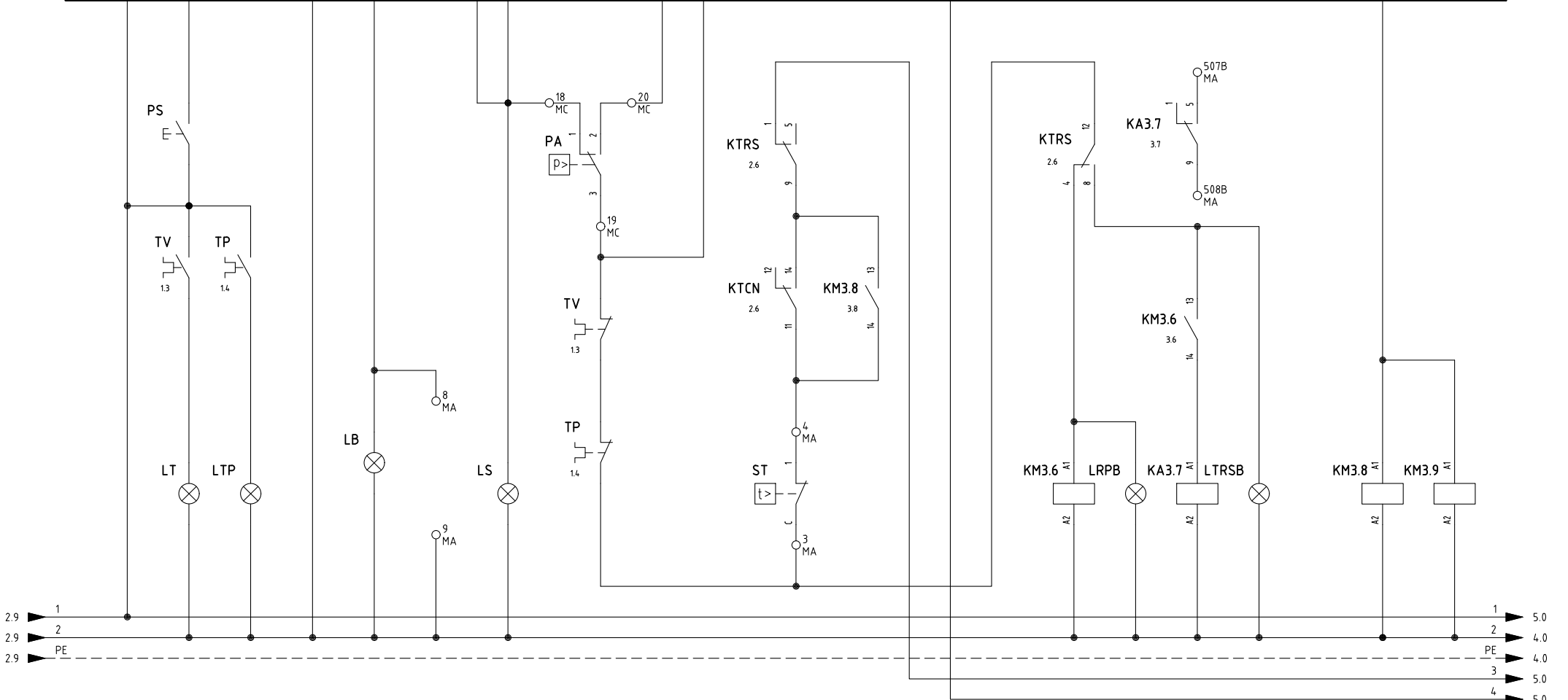

|           |            |       |        |
|-----------|------------|-------|--------|
| Data      | 29/02/2016 | PREC. | FOGLIO |
| Revisione | 01         | 2     | 3      |
| Dis. N.   | 11 - 0501  | SEGUE | TOTALE |
|           |            | 4     | 9      |

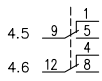
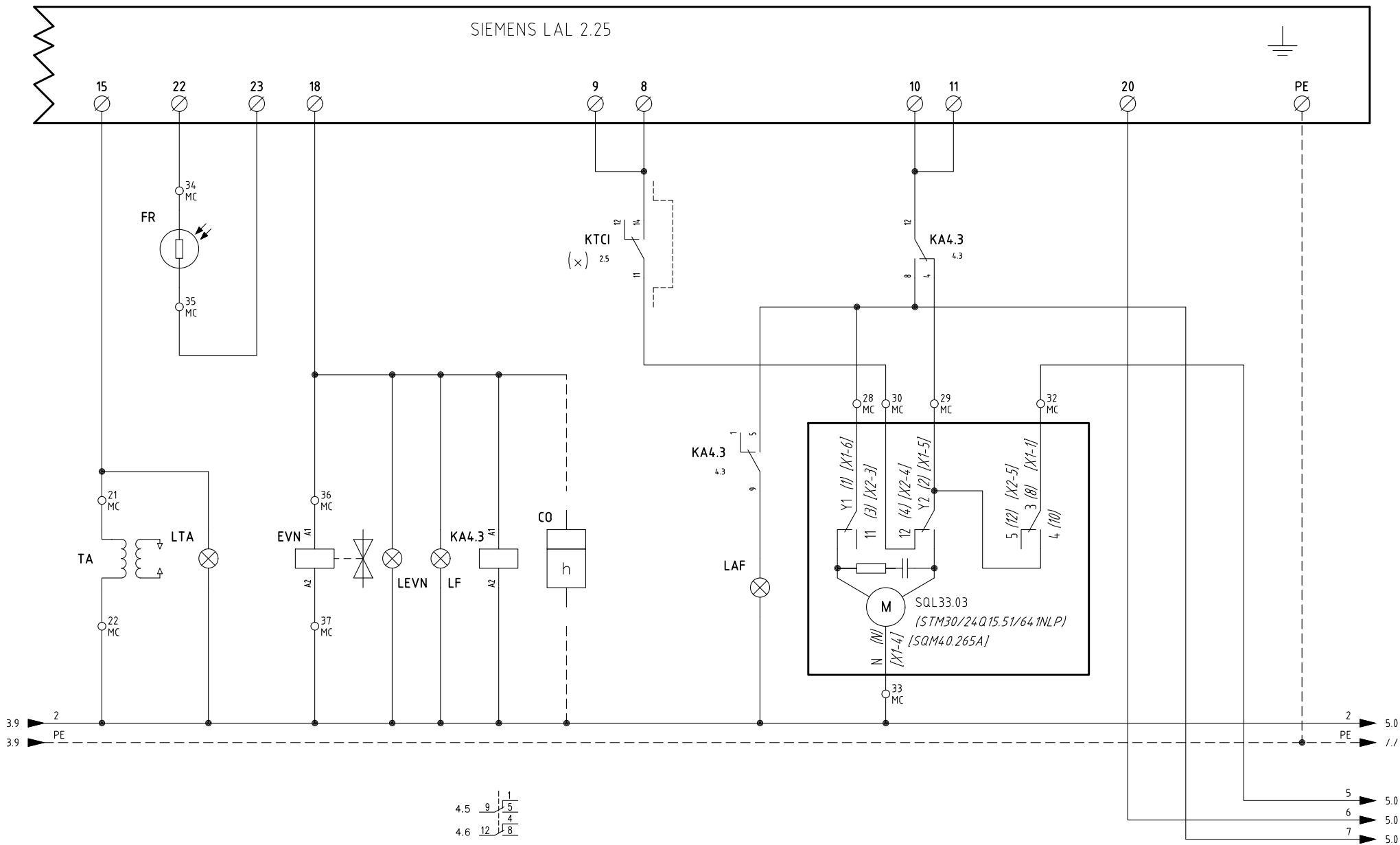

(X)  
INSTALLATO SOLO SU ALCUNE VERSIONI  
INSTALLED ON ANY VERSIONS ONLY

|           |            |       |        |
|-----------|------------|-------|--------|
| Data      | 29/02/2016 | PREC. | FOGLIO |
| Revisione | 01         | 3     | 4      |
| Dis. N.   | 11 - 0501  | SEGUE | TOTALE |
|           |            | 5     | 9      |

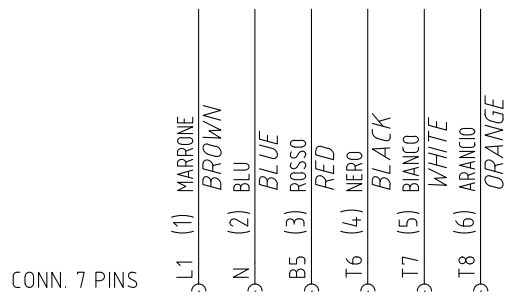
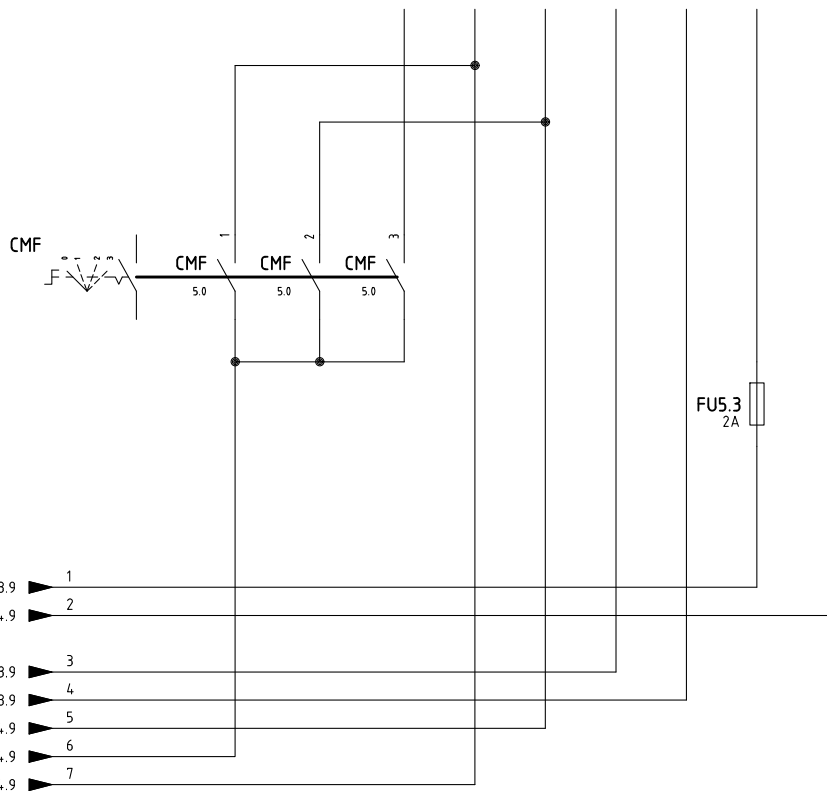
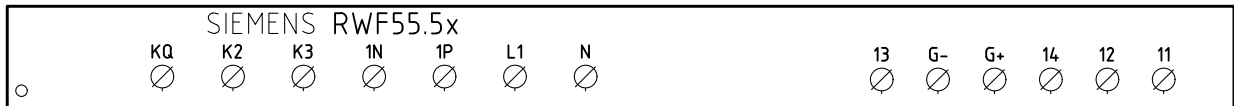
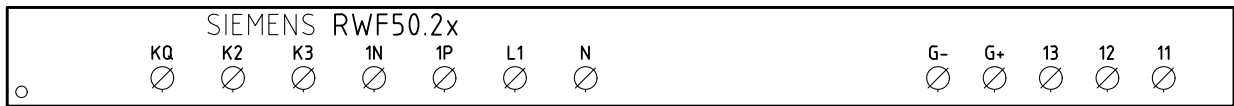
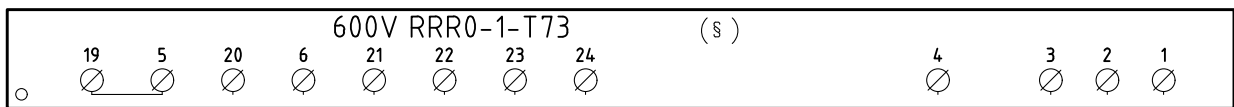
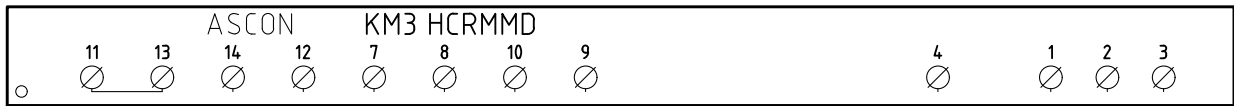

CAVO 7x0,75mmq  
7x0,75mmq CABLE

(xx)  
ATTENZIONE COLLEGAMENTO SONDE CON CONNETTORE 7 POLI  
WARNING PROBE CONNECTION WITH 7 PINS CONNECTOR

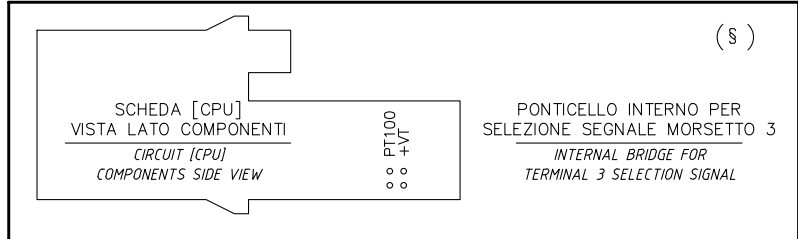

|           |            |       |        |
|-----------|------------|-------|--------|
| Data      | 29/02/2016 | PREC. | FOGLIO |
| Revisione | 01         | 4     | 5      |
| Dis. N.   | 11 - 0501  | SEGUE | TOTALE |
|           |            | 6     | 9      |

(xx)

ATTENZIONE COLLEGAMENTO SONDE CON CONNETTORE 7 POLI  
 WARNING PROBE CONNECTION WITH 7 PINS CONNECTOR

### KM3 HCRMMD

### 600V RRR0-1-T73

### RWF55.5x

### RWF50.2x

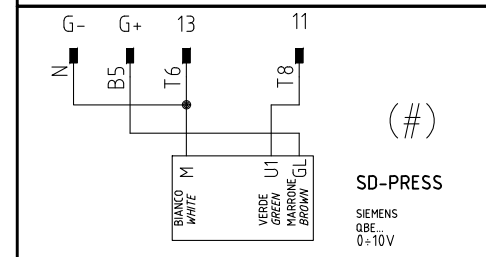
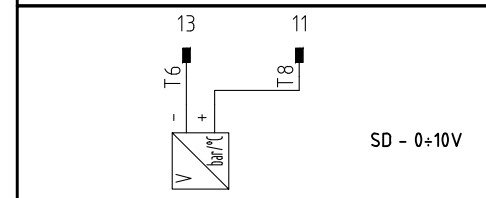
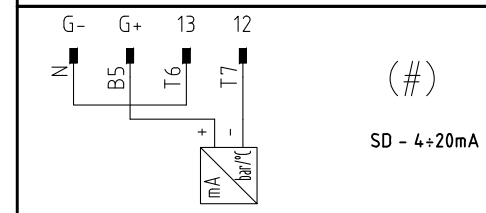
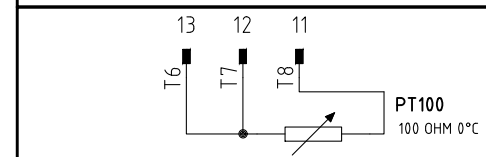
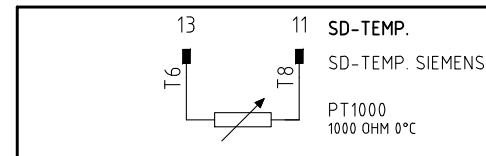
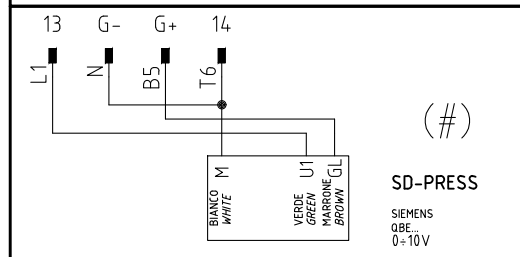
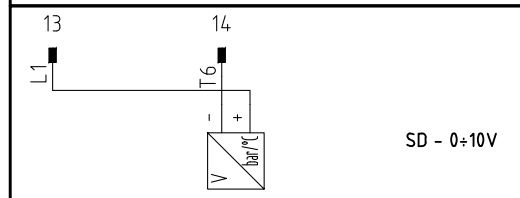
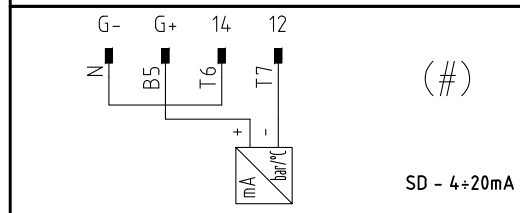
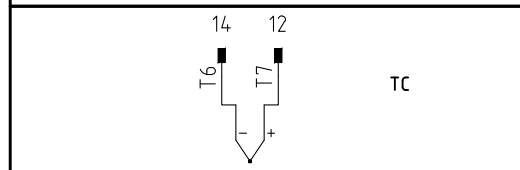
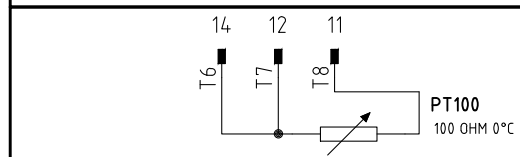
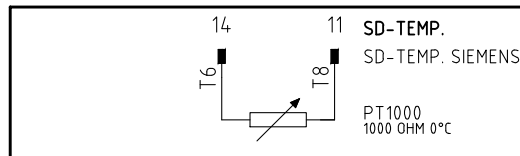
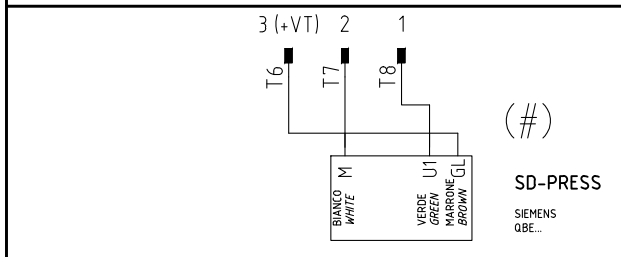
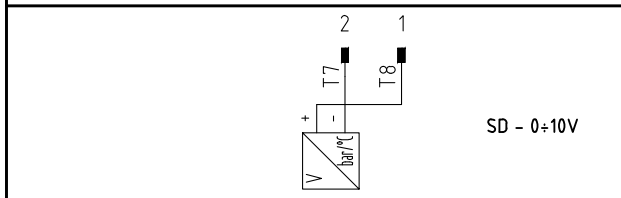
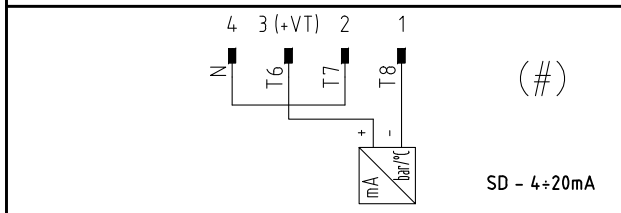
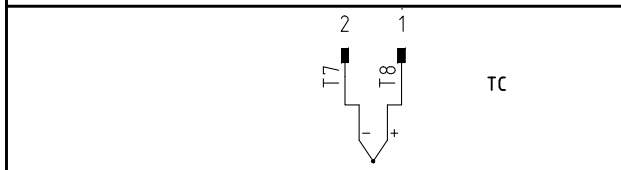
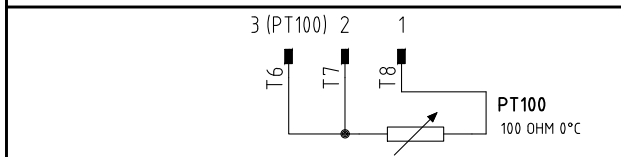
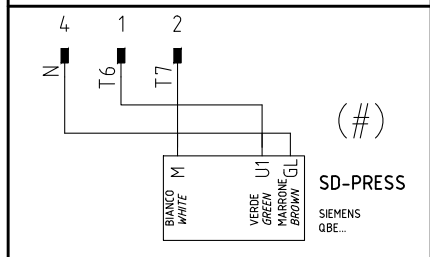
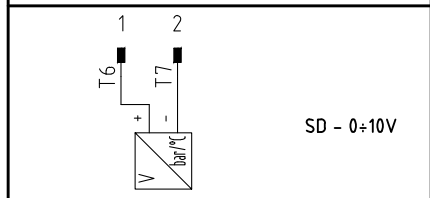
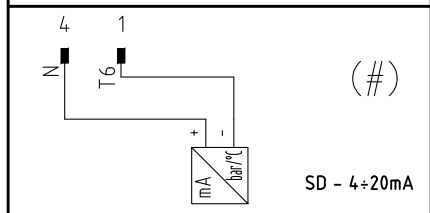
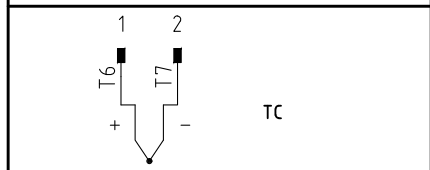
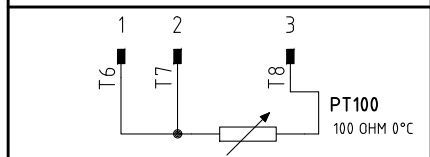
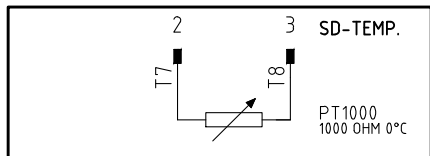

(#)

COLLEGAMENTO SOLO PER  
 TRASDUTTORI PASSIVI  
 TRANSDUCER PASSIVE  
 CONNECTION ONLY

|           |            |       |        |
|-----------|------------|-------|--------|
| Data      | 29/02/2016 | PREC. | FOGLIO |
| Revisione | 01         | 5     | 6      |
| Dis. N.   | 11 - 0501  | SEGUE | TOTALE |
|           |            | 7     | 9      |

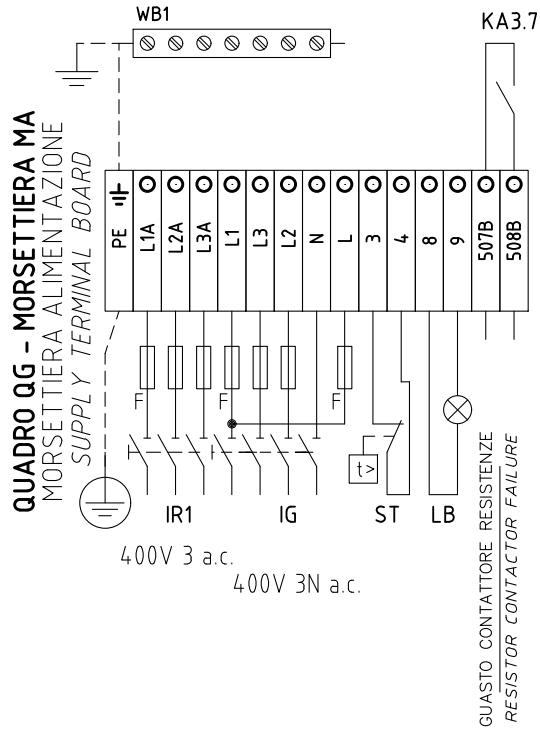

SERVOCOMANDO SERRANDA ARIA  
 AIR DAMPER ACTUATOR  
 [SQM40.265A]

- I ALTA FIAMMA  
HIGH FLAME
- II SOSTA E ACCENSIONE  
STAND-BY AND IGNITION
- III BASSA FIAMMA  
LOW FLAME

SERVOCOMANDO SERRANDA ARIA (ALTERNATIVO)  
 AIR DAMPER ACTUATOR (ALTERNATIVE)  
 (STM30/24Q15.51/641NLP)

- I ALTA FIAMMA  
HIGH FLAME
- II SOSTA E ACCENSIONE  
STAND-BY AND IGNITION
- III BASSA FIAMMA  
LOW FLAME

SERVOCOMANDO SERRANDA ARIA (ALTERNATIVO)  
 AIR DAMPER ACTUATOR (ALTERNATIVE)  
 SQL33.03

- Y1 ALTA FIAMMA  
HIGH FLAME
- Y2 SOSTA E ACCENSIONE  
STAND-BY AND IGNITION
- 3 BASSA FIAMMA  
LOW FLAME

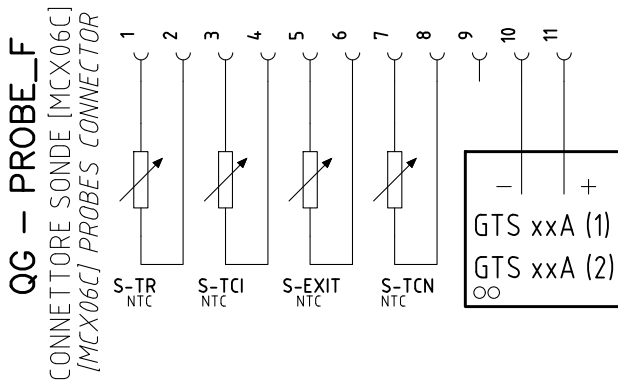

**QUADRO QG - MORSETTIERA MC**  
**MORSETTIERA COMPONENTI BRUCIATORE**  
**BURNER COMPONENT TERMINAL BOARD**

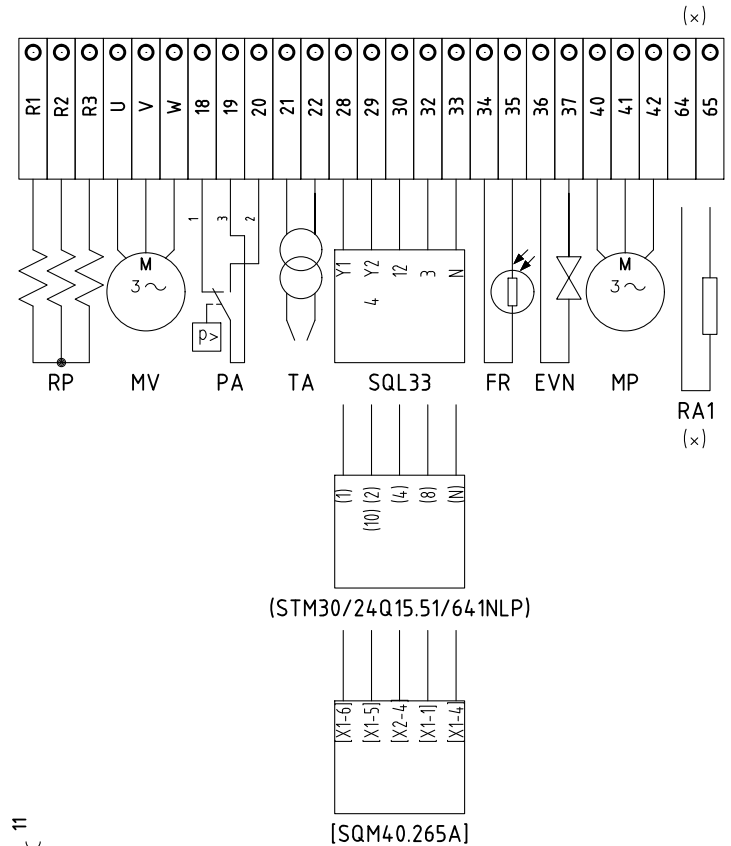

(x)  
 INSTALLATO SOLO SU ALCUNE VERSIONI  
 INSTALLED ON ANY VERSIONS ONLY

|           |            |       |        |
|-----------|------------|-------|--------|
| Data      | 29/02/2016 | PREC. | FOGLIO |
| Revisione | 01         | 6     | 7      |
| Dis. N.   | 11 - 0501  | SEGUE | TOTALE |
|           |            | 8     | 9      |

| Sigla/Item              | Foglio/Sheet | Funzione                                                                | Function                                                 |
|-------------------------|--------------|-------------------------------------------------------------------------|----------------------------------------------------------|
| 600V RRR0-1-T73         | 5            | REGOLATORE MODULANTE (ALTERNATIVO)                                      | BURNER MODULATOR (ALTERNATIVE)                           |
| (STM30/24Q15.51/641NLP) | 4            | SERVOCOMANDO SERRANDA ARIA (ALTERNATIVO)                                | AIR DAMPER ACTUATOR (ALTERNATIVE)                        |
| CMF                     | 5            | COMMUT. MANUALE FUNZ. 0)FERMO 1)ALTA FIAMMA 2)BASSA FIAMMA 3)AUTOMATICO | MANUAL SWITCH 0)OFF 1)HIGH FLAME 2)LOW FLAME 3)AUTOMATIC |
| CO                      | 4            | CONTAORE DI FUNZIONAMENTO (OPTIONAL)                                    | OPERATION TIME COUNTER (OPTIONAL)                        |
| EVN                     | 4            | ELETTROVALVOLA NAFTA                                                    | OIL SOLENOID VALVE                                       |
| FR                      | 4            | FOTORESISTENZA RILEVAZIONE FIAMMA                                       | PHOTORESISTOR FLAME DETECTOR                             |
| FU1.1                   | 1            | FUSIBILI LINEA PRERISCALDATORE [RPA]                                    | LINE PRE-HEATING [RPA] FUSES                             |
| FU1.2                   | 1            | FUSIBILI LINEA MOTORE VENTILATORE                                       | FAN MOTOR LINE FUSES                                     |
| FU1.4                   | 1            | FUSIBILI LINEA POMPA                                                    | PUMP LINE FUSES                                          |
| (x) FU1.6               | 1            | FUSIBILE RESISTENZE AUSILIARIE                                          | AUXILIARY HEATERS FUSE                                   |
| FU1.8                   | 1            | FUSIBILE LINEA AUSILIARI                                                | AUXILIARY LINE FUSE                                      |
| FU2.0                   | 2            | FUSIBILE AUSILIARIO                                                     | AUXILIARY FUSE                                           |
| FU2.1                   | 2            | FUSIBILE AUSILIARIO                                                     | AUXILIARY FUSE                                           |
| FU5.3                   | 5            | FUSIBILE                                                                | FUSE                                                     |
| GTS xxA (1)             | 2            | TIRISTORE                                                               | THYRISTOR                                                |
| GTS xxA (2)             | 2            | TIRISTORE                                                               | THYRISTOR                                                |
| IB                      | 1            | INTERRUTTORE LINEA BRUCIATORE                                           | BURNER LINE SWITCH                                       |
| IL                      | 1            | INTERRUTTORE LINEA AUSILIARI                                            | AUXILIARY LINE SWITCH                                    |
| (x) IR1                 | 1            | INTERRUTTORE LINEA RESISTENZE PRERISCALDATORE [RPA]                     | PRE-HEATING RESISTOR [RPA] LINE SWITCH                   |
| IRA                     | 1            | INTERRUTTORE RESISTENZE AUSILIARIE                                      | AUXILIARY HEATERS SWITCH                                 |
| KA3.7                   | 3            | RELE" AUSILIARIO SEGNALAZIONE GUASTO CONTATTORE RESISTENZE              | AUXILIARY RELAY FOR RESISTOR CONTACTOR FAILURE           |
| KA4.3                   | 4            | RELE" AUSILIARIO                                                        | AUXILIARY RELAY                                          |
| KM3.6                   | 3            | CONTATTORE RESISTENZE PRERISCALDATORE [RPB]                             | PRE-HEATING RESISTOR [RPB] CONTACTOR                     |
| KM3.8                   | 3            | CONTATTORE MOTORE VENTILATORE                                           | FAN MOTOR CONTACTOR                                      |
| KM3.9                   | 3            | CONTATTORE MOTORE POMPA NAFTA                                           | OIL PUMP MOTOR CONTACTOR                                 |
| KM3 HCRMMD              | 5            | REGOLATORE MODULANTE (ALTERNATIVO)                                      | BURNER MODULATOR (ALTERNATIVE)                           |
| (x) KTCI                | 2            | RELE" AUSILIARIO                                                        | AUXILIARY RELAY                                          |
| KTCN                    | 2            | RELE" AUSILIARIO                                                        | AUXILIARY RELAY                                          |
| KTRS                    | 2            | RELE" AUSILIARIO                                                        | AUXILIARY RELAY                                          |
| LAF                     | 4            | LAMPADA SEGNALAZIONE ALTA FIAMMA BRUCIATORE                             | BURNER IN HIGH FLAME INDICATOR LIGHT                     |
| LAL 2.25                | 3            | APPARECCHIATURA CONTROLLO FIAMMA                                        | CONTROL BOX                                              |
| LB                      | 3            | LAMPADA SEGNALAZIONE BLOCCO BRUCIATORE                                  | INDICATOR LIGHT FOR BURNER LOCK-OUT                      |
| LEVN                    | 4            | LAMPADA SEGNALAZIONE APERTURA [EVN]                                     | INDICATOR LIGHT FOR OPENING OF ELECTRO-VALVE [EVN]       |
| LF                      | 4            | LAMPADA SEGNALAZIONE BASSA FIAMMA BRUCIATORE                            | BURNER IN LOW FLAME INDICATOR LIGHT                      |

(x)  
 INSTALLATO SOLO SU ALCUNE VERSIONI  
 INSTALLED ON ANY VERSIONS ONLY

|           |            |       |        |
|-----------|------------|-------|--------|
| Data      | 29/02/2016 | PREC. | FOGLIO |
| Revisione | 01         | 7     | 8      |
| Dis. N.   | 11 - 0501  | SEGUE | TOTALE |
|           |            | 9     | 9      |



| Sigla/Item   | Foglio/Sheet | Funzione                                                   | Function                                                 |
|--------------|--------------|------------------------------------------------------------|----------------------------------------------------------|
| LRPB         | 3            | LAMPADA SEGNALAZIONE FUNZIONAMENTO PRERISCALDATORE [RPB]   | INDICATOR LIGHT FOR PRE-HEATING RESISTOR [RPB] OPERATION |
| LS           | 3            | LAMPADA SEGNALAZIONE SOSTA BRUCIATORE                      | INDICATOR LIGHT FOR BURNER STAND-BY                      |
| LT           | 3            | LAMPADA SEGNALAZIONE BLOCCO TERMICO                        | INDICATOR LIGHT FOR MOTOR OVERLOAD THERMAL CUTOUT        |
| LTA          | 4            | LAMPADA SEGNALAZIONE TRASFORMATORE DI ACCENSIONE           | IGNITION TRANSFORMER INDICATOR LIGHT                     |
| LTP          | 3            | LAMPADA SEGNALAZIONE BLOCCO TERMICO MOTORE POMPA           | INDICATOR LIGHT FOR PUMP MOTOR OVERLOAD THERMAL CUTOUT   |
| LTRSB        | 3            | LAMPADA SEGNALAZIONE BLOCCO TERMOSTATO DI SICUREZZA [TRSB] | INDICATOR LIGHT FOR [TRSB] SAFETY THERMOSTAT             |
| MCX06C       | 2            | REGOLATORE TEMPERATURE NAFTA                               | OIL TEMPERATURE REGULATOR                                |
| MP           | 1            | MOTORE POMPA NAFTA                                         | OIL PUMP MOTOR                                           |
| MV           | 1            | MOTORE VENTILATORE                                         | FAN MOTOR                                                |
| PA           | 3            | PRESSOSTATO ARIA                                           | AIR PRESSURE SWITCH                                      |
| PS           | 3            | PULSANTE SBLOCCO FIAMMA                                    | FLAME UNLOCK BUTTON                                      |
| PT100        | 6            | SONDA DI TEMPERATURA                                       | TEMPERATURE PROBE                                        |
| (x) RA       | 1            | RESISTENZE AUSILIARIE                                      | AUXILIARY HEATERS                                        |
| RP           | 1            | RESISTENZE PRERISCALDATORE NAFTA                           | PRE-HEATING TANK RESISTORS                               |
| RWF50.2x     | 5            | REGOLATORE MODULANTE                                       | BURNER MODULATOR                                         |
| RWF55.5x     | 5            | REGOLATORE MODULANTE (ALTERNATIVO)                         | BURNER MODULATOR (ALTERNATIVE)                           |
| (x) S-EXIT   | 2            | SONDA TEMPERATURA USCITA BARILOTTO                         | TANK OUTLET OIL TEMPERATURE PROBE                        |
| (x) S-TCI    | 2            | SONDA TEMPERATURA CONSENSO IMPIANTO                        | PLANT CONSENT TEMPERATURE PROBE                          |
| S-TCN        | 2            | SONDA TEMPERATURA CONSENSO NAFTA                           | OIL CONSENT TEMPERATURE PROBE                            |
| S-TR         | 2            | SONDA TEMPERATURA RESISTENZE                               | RESISTOR TEMPERATURE PROBE                               |
| SD-PRESS     | 6            | SONDA DI PRESSIONE                                         | PRESSURE PROBE                                           |
| SD-TEMP.     | 6            | SONDA DI TEMPERATURA                                       | TEMPERATURE PROBE                                        |
| SD - 0÷10V   | 6            | TRASDUTTORE USCITA IN TENSIONE                             | TRANSDUCER VOLTAGE OUTPUT                                |
| SD - 4÷20mA  | 6            | TRASDUTTORE USCITA IN CORRENTE                             | TRANSDUCER CURRENT OUTPUT                                |
| SQL33.03     | 4            | SERVOCOMANDO SERRANDA ARIA                                 | AIR DAMPER ACTUATOR                                      |
| ST           | 3            | SERIE TERMOSTATI/PRESSOSTATI                               | SERIES OF THERMOSTATS OR PRESSURE SWITCHES               |
| TA           | 4            | TRASFORMATORE DI ACCENSIONE                                | IGNITION TRANSFORMER                                     |
| TC           | 6            | TERMOCOPPIA                                                | THERMOCOUPLE                                             |
| TP           | 1            | TERMICO MOTORE POMPA                                       | PUMP MOTOR THERMAL                                       |
| TRAFO        | 2            | TRASFORMATORE AUSILIARIO                                   | AUXILIARY TRANSFORMER                                    |
| TV           | 1            | TERMICO MOTORE VENTILATORE                                 | FAN MOTOR THERMAL                                        |
| WB1          | 1            | BARRA DI TERRA                                             | EARTH TERMINAL                                           |
| [SQM40.265A] | 4            | SERVOCOMANDO SERRANDA ARIA (ALTERNATIVO)                   | AIR DAMPER ACTUATOR (ALTERNATIVE)                        |

(x)  
 INSTALLATO SOLO SU ALCUNE VERSIONI  
 INSTALLED ON ANY VERSIONS ONLY

|           |            |       |        |
|-----------|------------|-------|--------|
| Data      | 29/02/2016 | PREC. | FOGLIO |
| Revisione | 01         | 8     | 9      |
| Dis. N.   | 11 - 0501  | SEGUE | TOTALE |
|           |            | 1     | 9      |