

Impianto  
 TIPI/TYPES HR91A ÷ HR520A / HRX92R ÷ HRX520 / HTP91A ÷ HTP520A  
 MODELLO/MODEL xG.PR(MD).x.xx.A.1.xx.EC  
 Descrizione  
 LMV26 + COD. 6100562 + COD. 6100566

Ordine  
 Commessa  
 Esecutore  
 U. PINTON

Data Controllato  
 22/05/2015  
 Controllato  
 G. SCATTOLIN

Data 25/05/2015  
 Revisione 00  
 Dis. N. 09 - 0430

PREC. /  
 FOGLIO 1  
 SEQUE 2  
 TOTALE 13

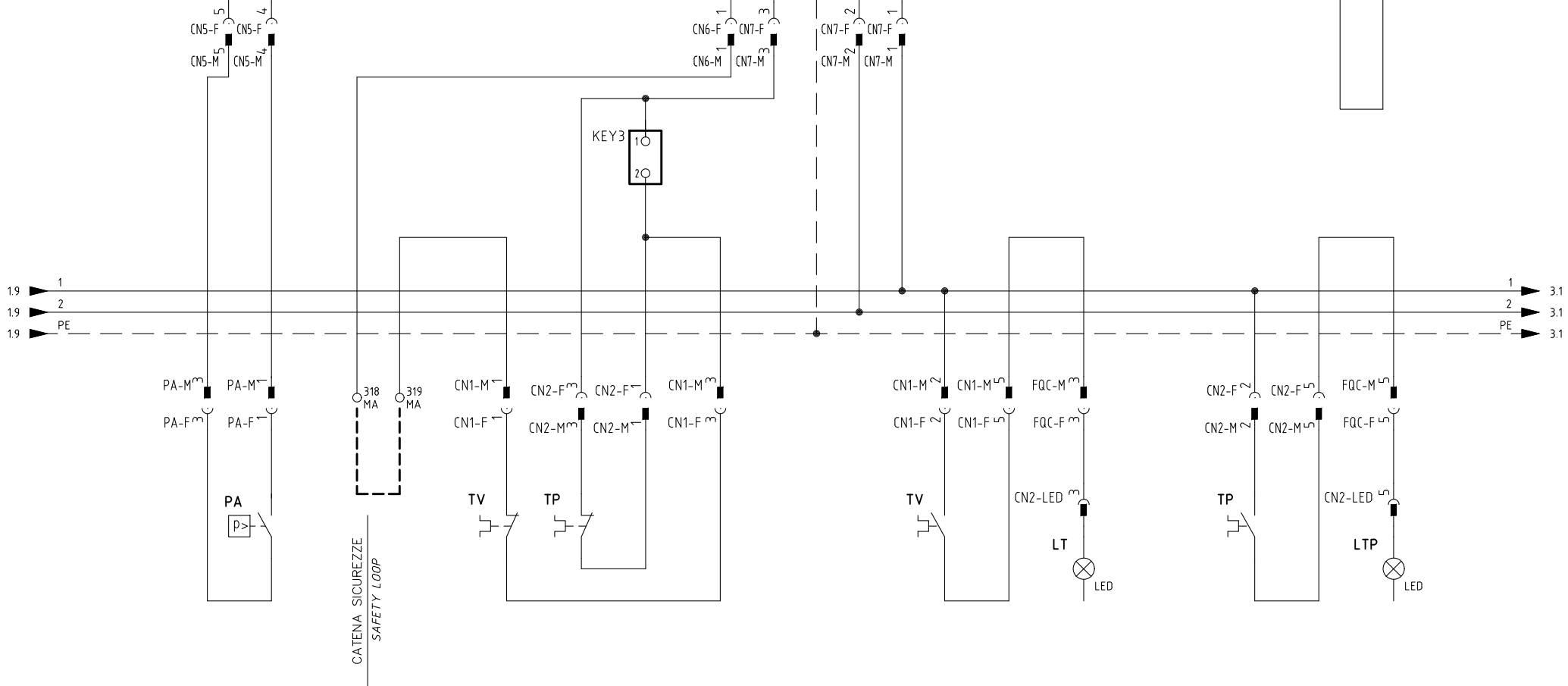
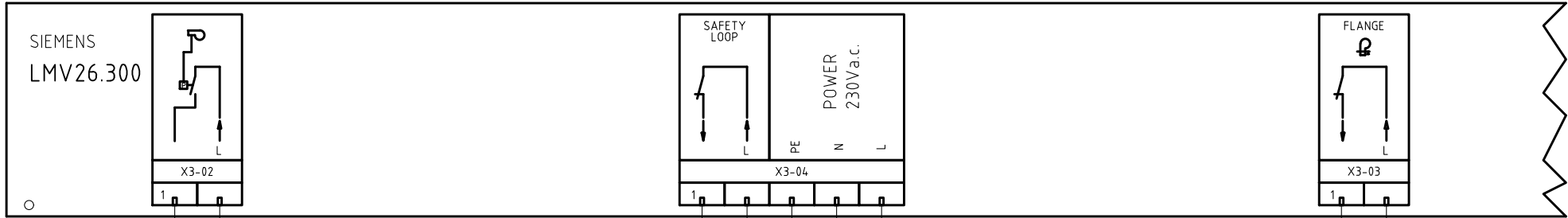

Data	25/05/2015	PREC.	FOGLIO
Revisione	00	1	2
Dis. N.	09 - 0430	SEGUE	TOTALE
		3	13

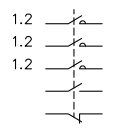
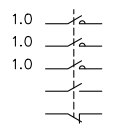
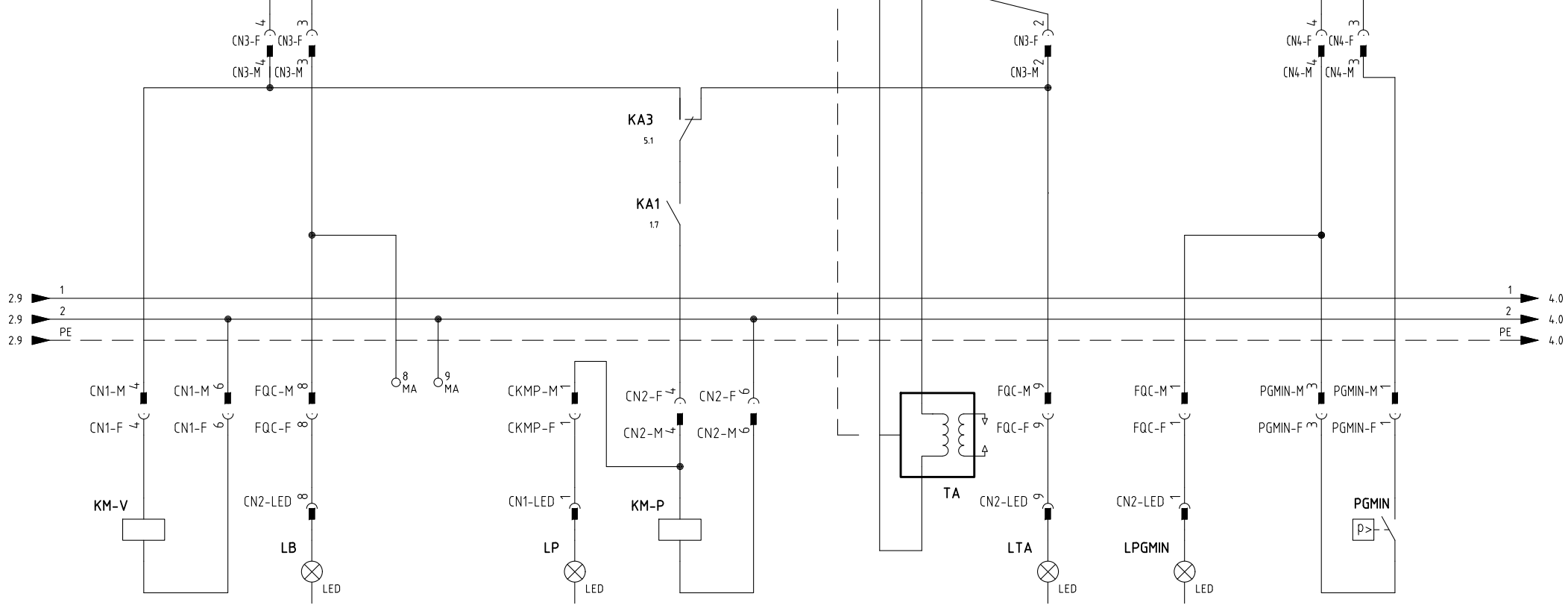
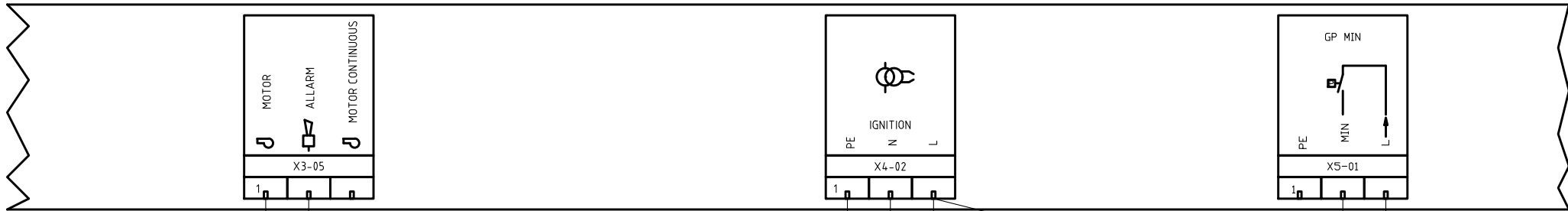

Data	25/05/2015	PREC.	FOGLIO
Revisione	00	2	3
Dis. N.	09 - 0430	SEGUE	TOTALE
		4	13

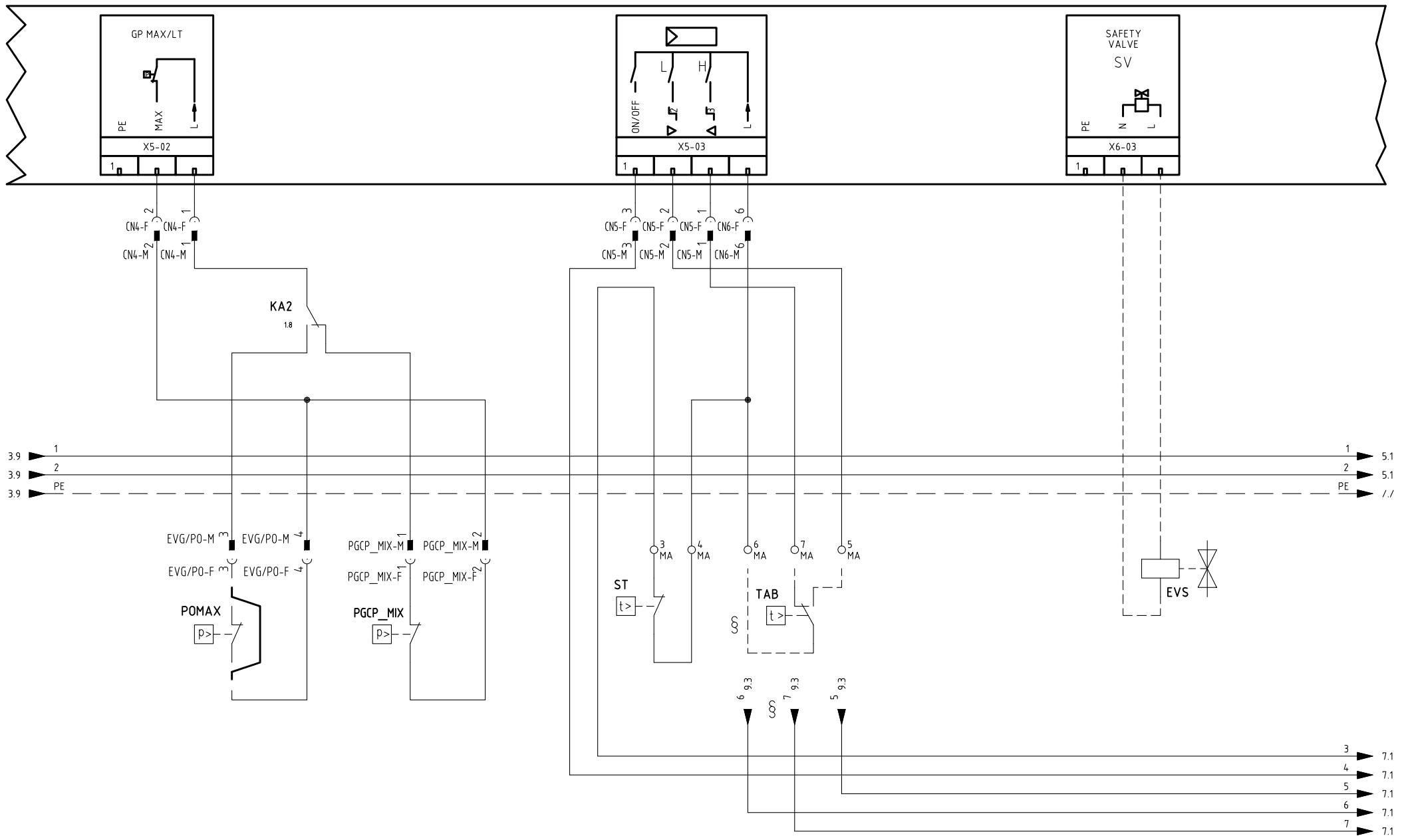

§

VERSIONE (PR) / VERSIONE (MD) CON RWF.. / 600V / KM3  
 (PR) VERSION / (MD) VERSION WITH RWF.. / 600V / KM3

Data	25/05/2015	PREC.	FOGLIO
Revisione	00	3	4
Dis. N.	09 - 0430	SEGUE	TOTALE
		5	13

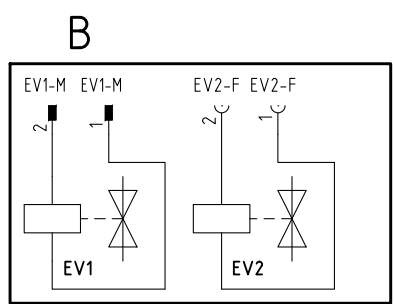
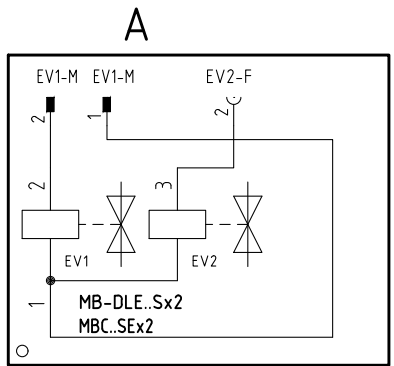
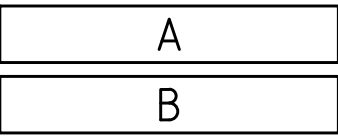
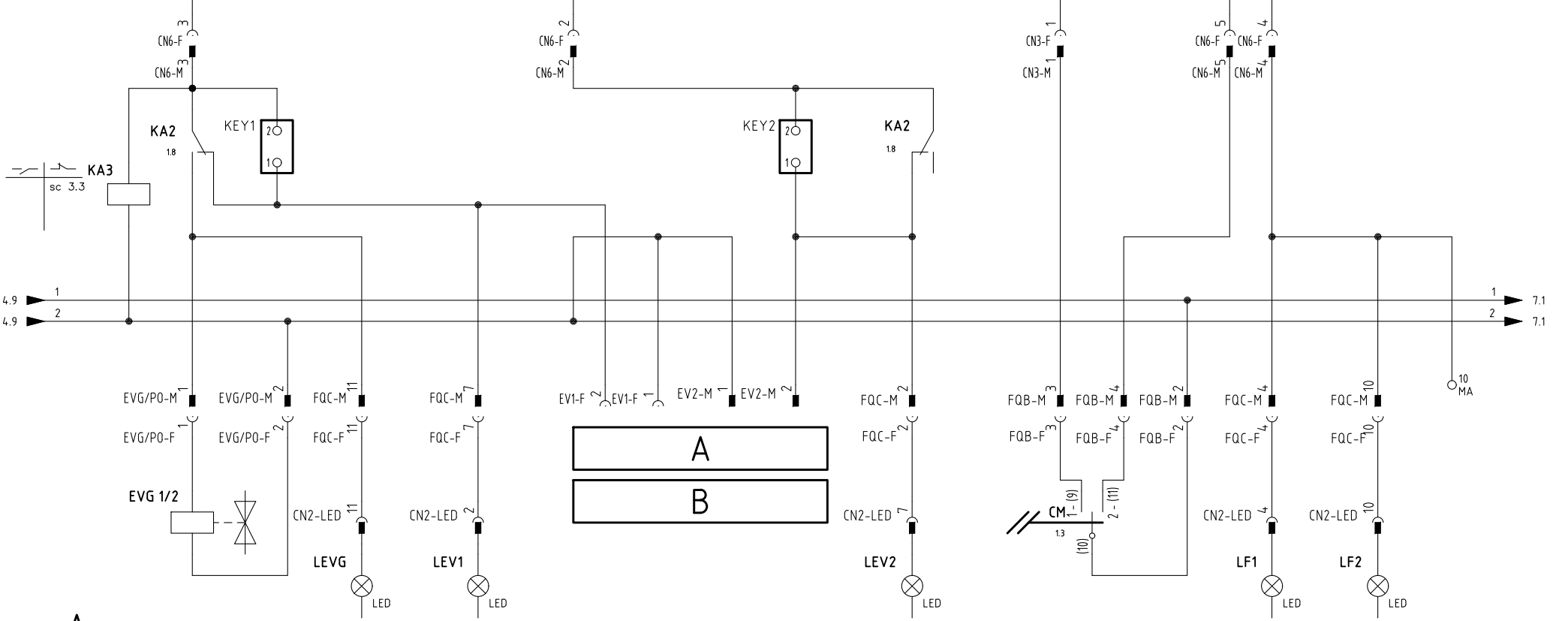
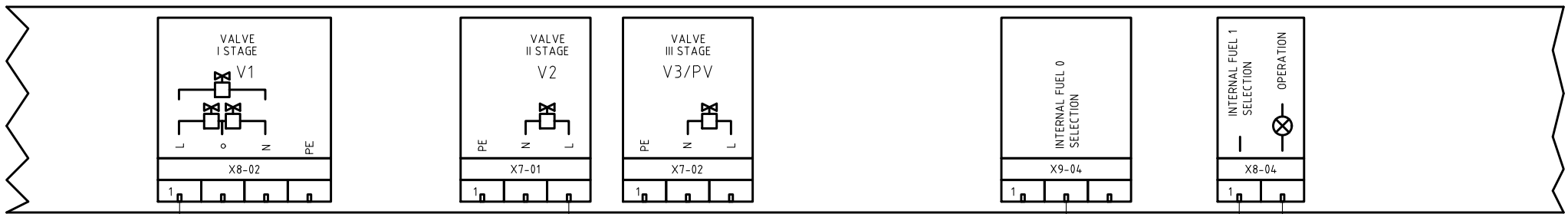

Data	25/05/2015	PREC.	FOGLIO
Revisione	00	4	5
Dis. N.	09 - 0430	SEGUE	TOTALE
		6	13

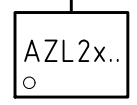
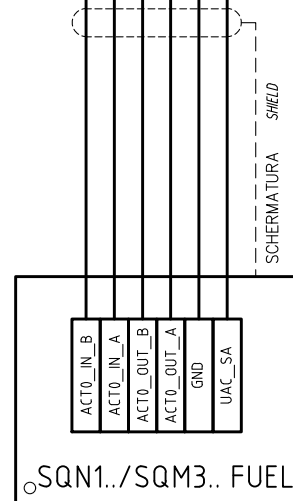
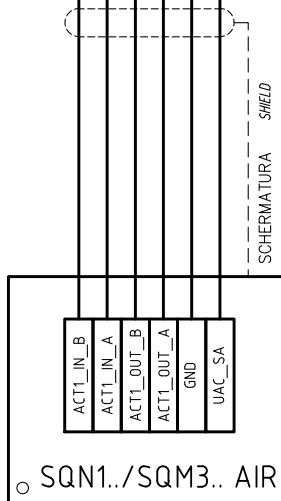
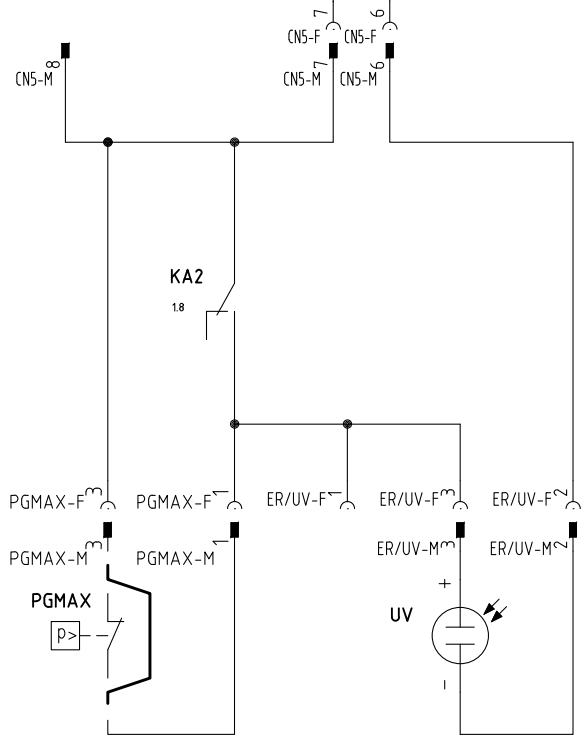
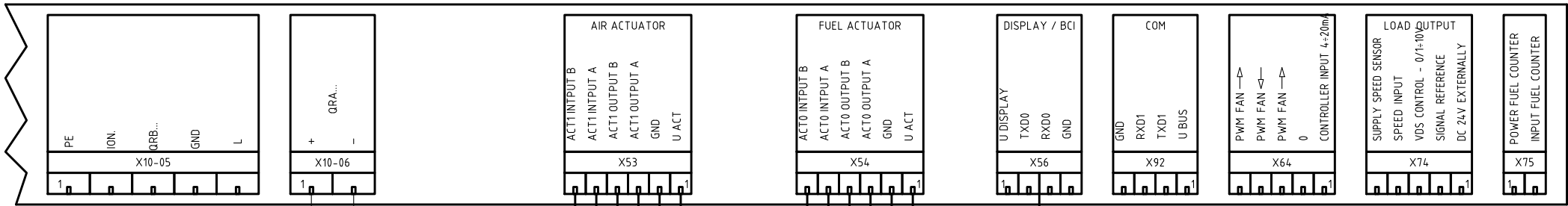

Data	25/05/2015	PREC.	FOGLIO
Revisione	00	5	6
Dis. N.	09 - 0430	SEGUE	TOTALE
		7	13

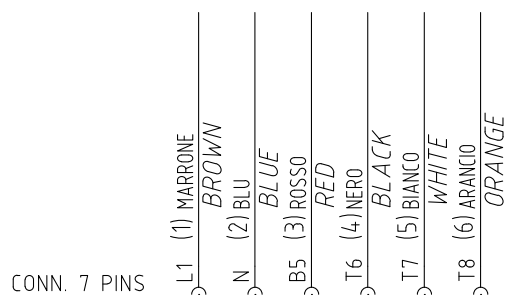
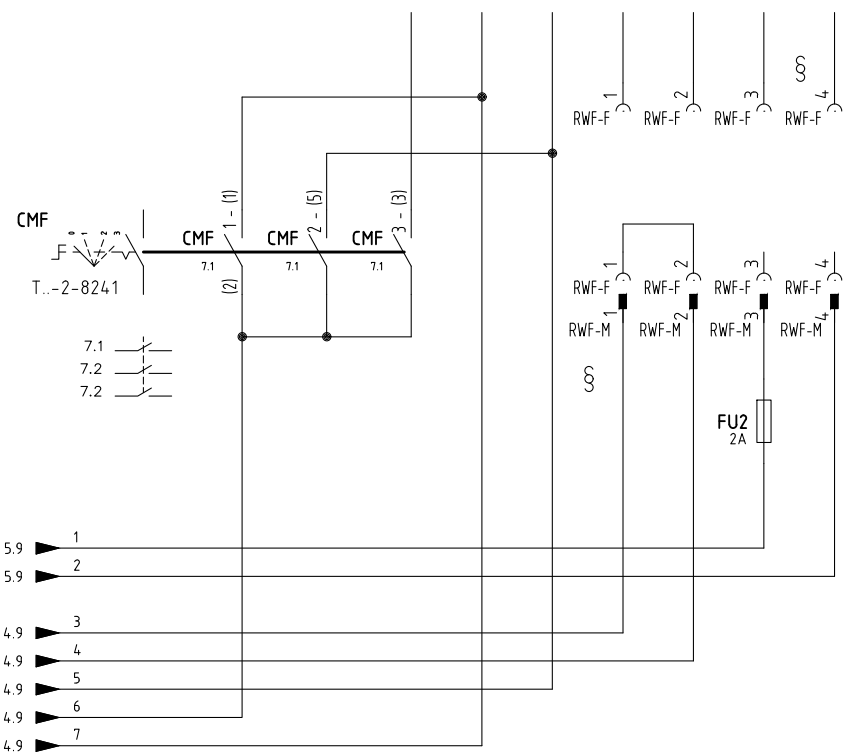
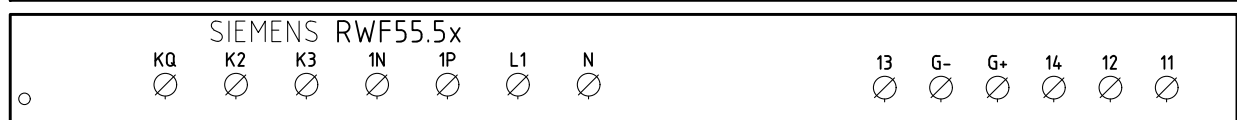
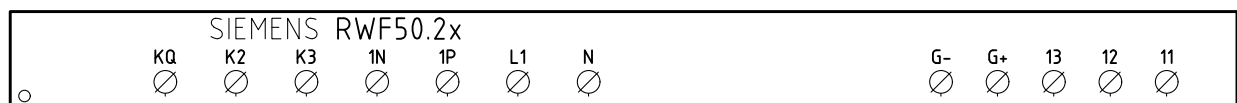
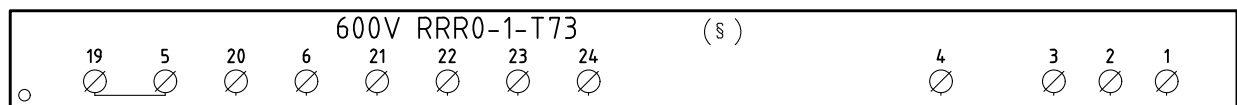
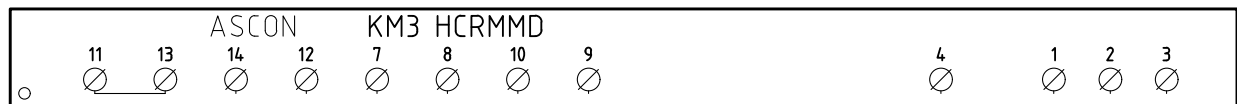

CAVO 7x0,75mmq  
7x0,75mmq CABLE

(xx)  
ATTENZIONE COLLEGAMENTO SONDE CON CONNETTORE 7 POLI  
WARNING PROBE CONNECTION WITH 7 PINS CONNECTOR

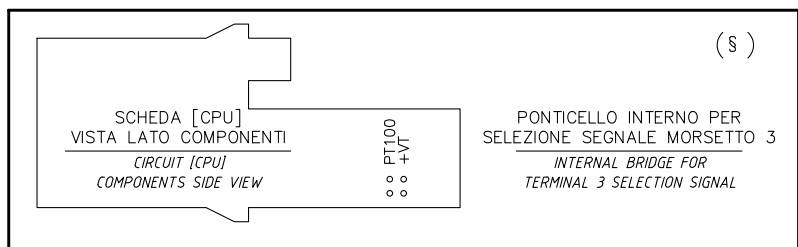

§  
VERSIONE (PR) / VERSIONE (MD) CON RWF.. / 600V / KM3  
(PR) VERSION / (MD) VERSION WITH RWF.. / 600V / KM3

Data	25/05/2015	PREC.	FOGLIO
Revisione	00	6	7
Dis. N.	09 - 0430	SEQUE	TOTALE
		8	13

(xx)

ATTENZIONE COLLEGAMENTO SONDE CON CONNETTORE 7 POLI  
 WARNING PROBE CONNECTION WITH 7 PINS CONNECTOR

### KM3 HCRMMD

### 600V RRR0-1-T73

### RWF55.5x

### RWF50.2x

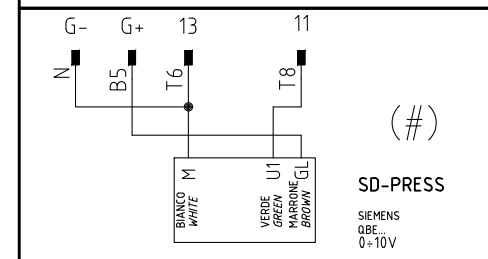
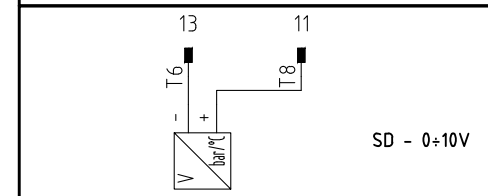
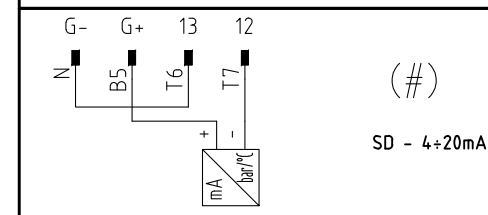
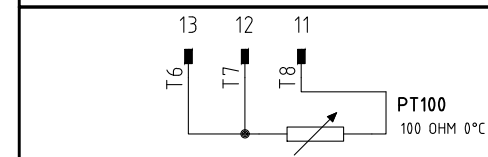
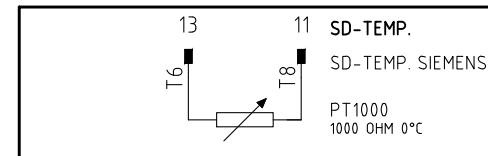
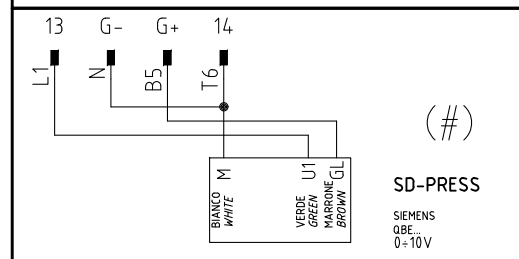
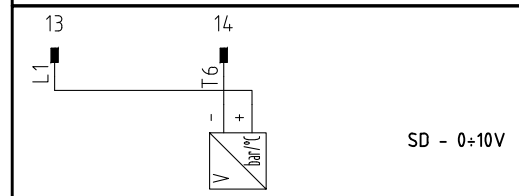
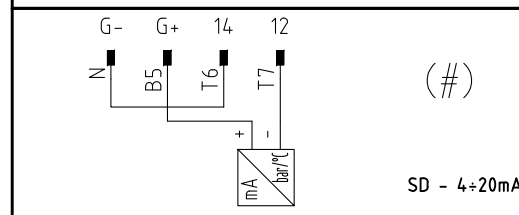
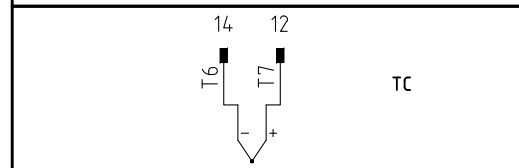
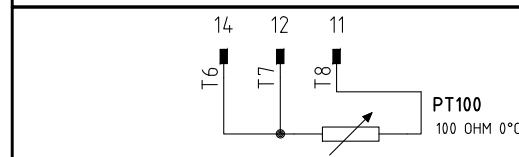
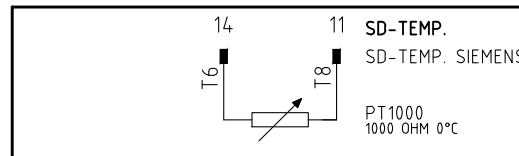
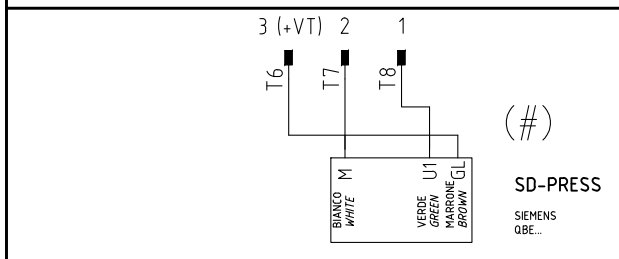
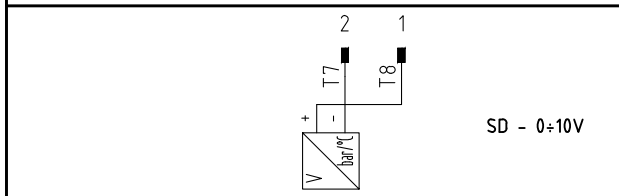
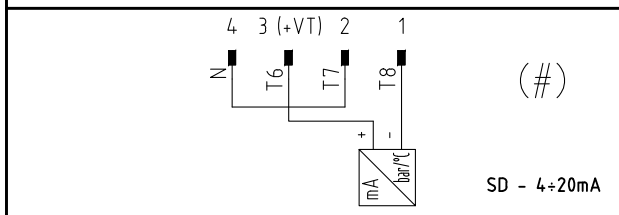
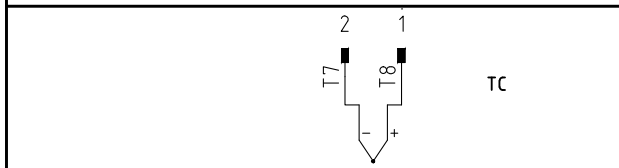
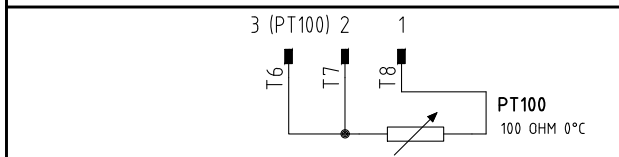
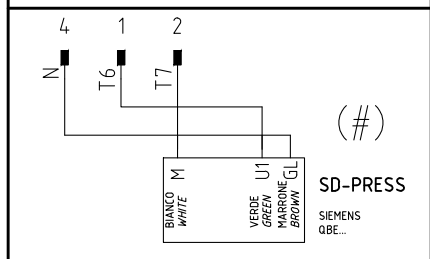
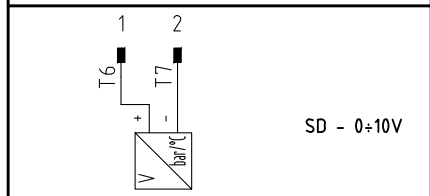
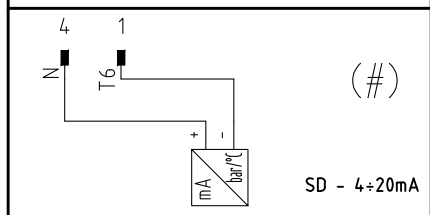
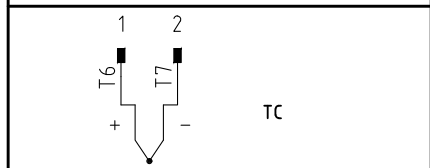
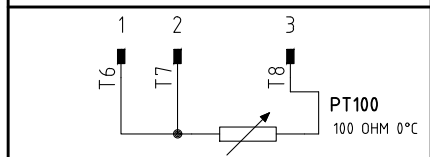
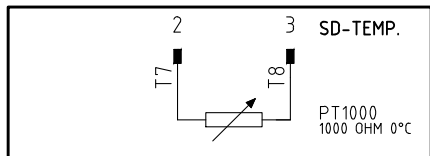

(#)

COLLEGAMENTO SOLO PER TRASDUTTORI PASSIVI  
 TRASDUCER PASSIVE CONNECTION ONLY

Data	25/05/2015	PREC.	FOGLIO
Revisione	00	7	8
Dis. N.	09 - 0430	SEGUE	TOTALE
		9	13



**QUADRO QG - MORSETTIERA MA**  
**MORSETTIERA ALIMENTAZIONE BRUCIATORE**  
**BURNER SUPPLY TERMINAL BOARD**

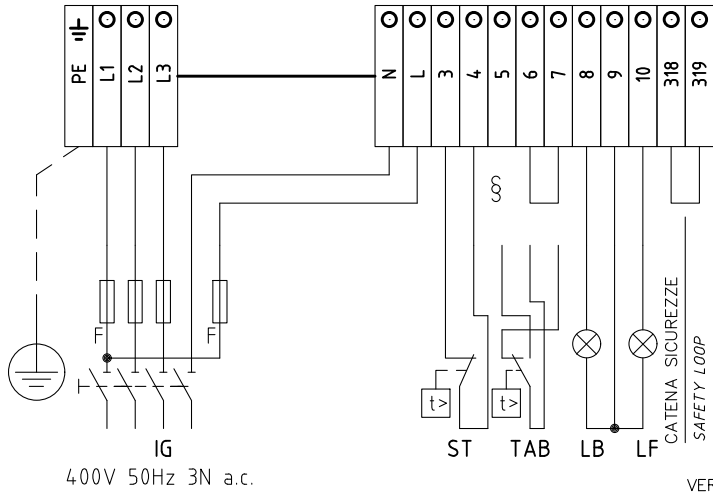

400V 50Hz 3N a.c.

LIMITE DI FORNITURA  
 SCOPE OF SUPPLY

VERSIONE (PR) / VERSIONE (MD) CON RWF.. / 600V / KM3  
 (PR) VERSION / (MD) VERSION WITH RWF.. / 600V / KM3

SE USATO "TAB" O "MD", TOGLIERE IL PONTE TRA I MORSETTI 6 - 7  
 IF USED "TAB" OR "MD", REMOVE THE BRIDGE BETWEEN TERMINALS 6 - 7

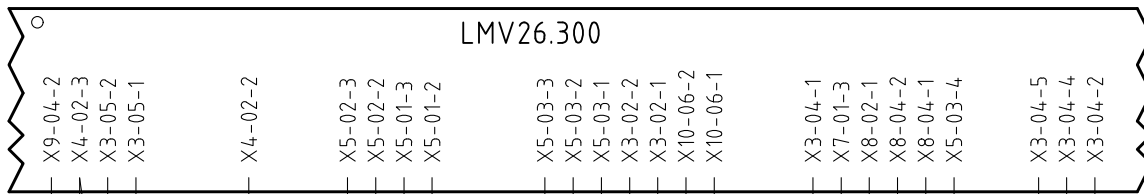

QG - CN3-F

QG - CN4-F

QG - CN5-F

QG - CN6-F

QG - CN7-F

TA

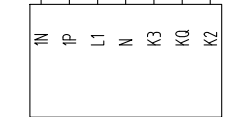
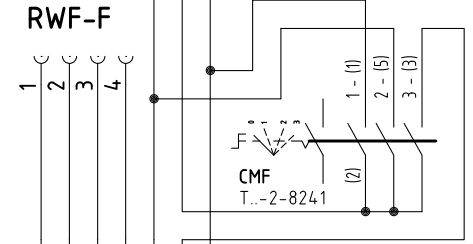

RWF50.2x - RWF55.5x

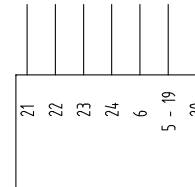

600V RRR0-1-T73

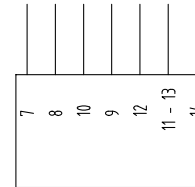

KM3 HCRMMD

Data	25/05/2015	PREC.	FOGLIO
Revisione	00	8	9
Dis. N.	09 - 0430	SEGUE	TOTALE
		10	13

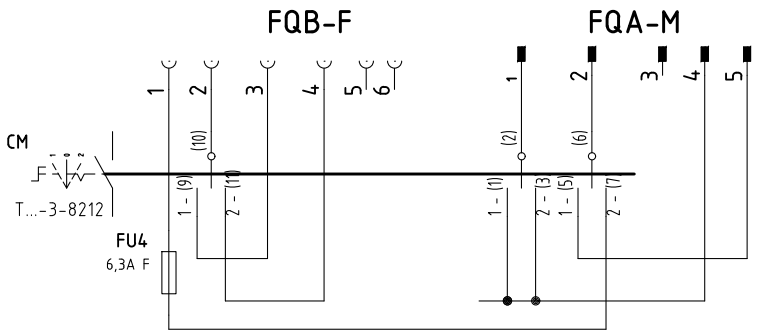
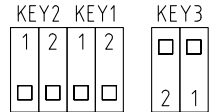
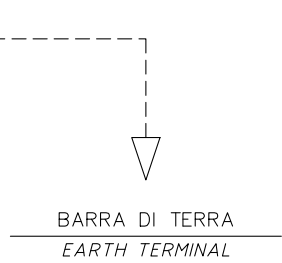
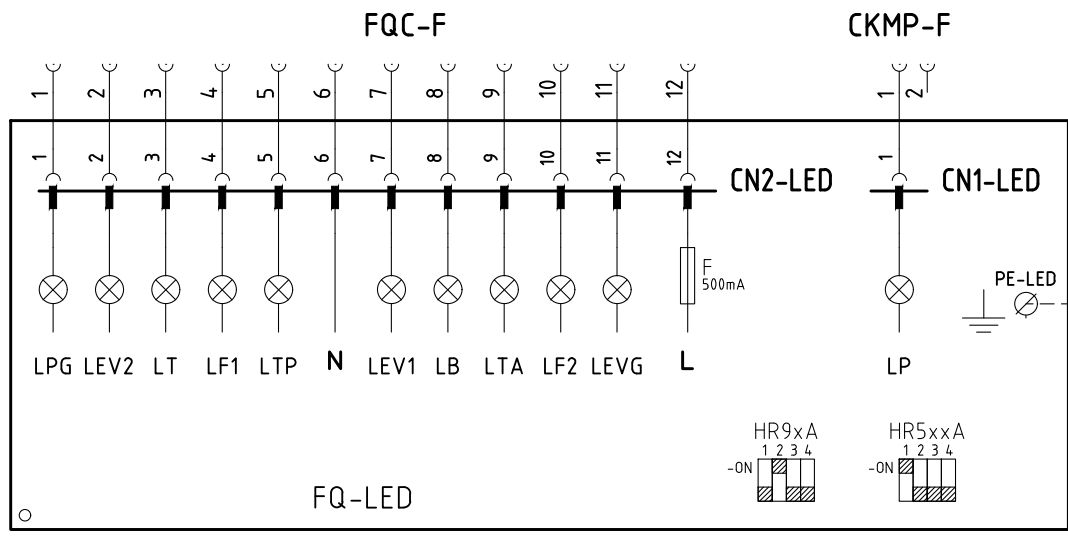
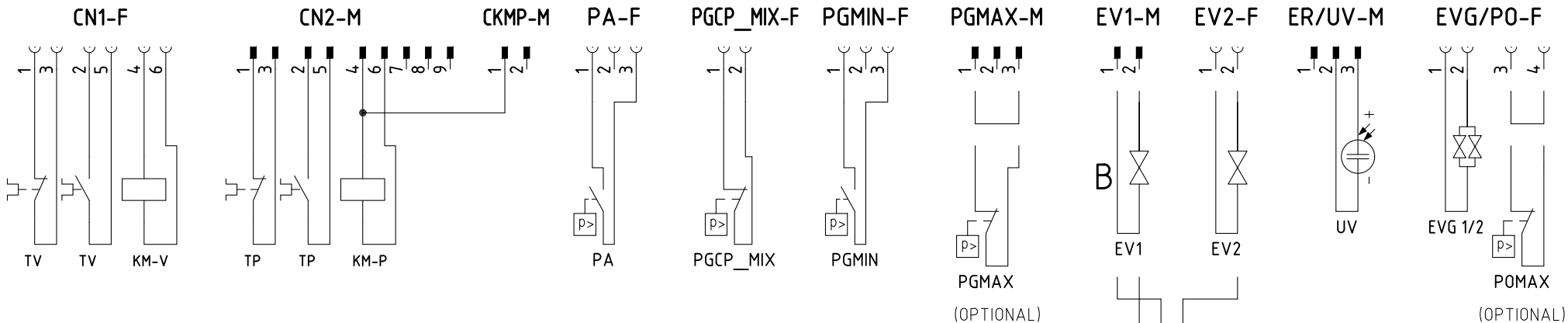

Data	25/05/2015	PREC.	FOGLIO
Revisione	00	9	10
Dis. N.	09 - 0430	SEGUE	TOTALE
		11	13

Sigla/Item	Foglio/Sheet	Funzione	Function
600V RRR0-1-T73	7	REGOLATORE MODULANTE (ALTERNATIVO)	BURNER MODULATOR (ALTERNATIVE)
AZL2x..	6	INTERFACCIA UTENTE	USER INTERFACE
CM	1	COMMUTATORE FUNZIONAMENTO 1)GAS 0)SPENTO 2)GASOLIO	MANUAL OPERATION SWITCH 1)GAS 0)OFF 2)LIGHT OIL
CMF	7	COMMUT. MANUALE FUNZ. 0)FERMO 1)ALTA FIAMMA 2)BASSA FIAMMA 3)AUTOMATICO	MANUAL SWITCH 0)OFF 1)HIGH FLAME 2)LOW FLAME 3)AUTOMATIC
EV1	5	ELETTROVALVOLA GAS LATO RETE	UPSTREAM GAS SOLENOID VALVE
EV2	5	ELETTROVALVOLA GAS LATO BRUCIATORE	DOWNSTREAM GAS SOLENOID VALVE
EVG 1/2	5	ELETTROVALVOLE GASOLIO	LIGHT OIL ELECTRO VALVES
EVS	4	ELETTROVALVOLA GAS DI SICUREZZA (OPTIONAL)	SAFETY GAS SOLENOID VALVE (OPTIONAL)
FQ-LED	10	PANNELLO FRONTALE (LED)	FRONT PANEL (LED)
FU1	1	FUSIBILE AUSILIARIO	AUXILIARY FUSE
FU2	7	FUSIBILE	FUSE
FU3	1	FUSIBILI LINEA POMPA	PUMP LINE FUSES
FU4	1	FUSIBILE AUSILIARIO	AUXILIARY FUSE
FU-A	1	FUSIBILI DI LINEA	LINE FUSES
FU-B	1	FUSIBILE DI LINEA	LINE FUSE
IG	1	INTERRUTTORE GENERALE	MAINS SWITCH
KA1	1	RELE" AUSILIARIO	AUXILIARY RELAY
KA2	1	RELE" AUSILIARIO	AUXILIARY RELAY
KA3	5	RELE" AUSILIARIO	AUXILIARY RELAY
KM3 HCRMMD	7	REGOLATORE MODULANTE (ALTERNATIVO)	BURNER MODULATOR (ALTERNATIVE)
KM-P	3	CONTATTORE MOTORE POMPA GASOLIO	LIGHT OIL PUMP MOTOR CONTACTOR
KM-V	3	CONTATTORE MOTORE VENTILATORE	FAN MOTOR CONTACTOR
LB	3	LAMPADA SEGNALAZIONE BLOCCO BRUCIATORE	INDICATOR LIGHT FOR BURNER LOCK-OUT
LEV1	5	LAMPADA SEGNALAZIONE APERTURA [EV1]	INDICATOR LIGHT FOR OPENING OF ELECTRO-VALVE [EV1]
LEV2	5	LAMPADA SEGNALAZIONE APERTURA [EV2]	INDICATOR LIGHT FOR OPENING OF ELECTRO-VALVE [EV2]
LEVG	5	LAMPADA SEGNALAZIONE APERTURA [EVG]	INDICATOR LIGHT FOR OPENING OF ELECTRO-VALVE [EVG]
LF1	5	LAMPADA SEGNALAZIONE FUNZIONAMENTO BRUCIATORE	INDICATOR LIGHT BURNER OPERATION
LF2	5	LAMPADA SEGNALAZIONE FUNZIONAMENTO BRUCIATORE	INDICATOR LIGHT BURNER OPERATION
LMV26.300	2	APPARECCHIATURA DI COMANDO	CONTROL SCHEME
LP	3	LAMPADA SEGNALAZIONE FUNZIONAMENTO POMPA	INDICATOR LIGHT FOR PUMP OPERATION
LPGMIN	3	LAMPADA SEGNALAZIONE PRESENZA GAS IN RETE	INDICATOR LIGHT FOR PRESENCE OF GAS IN THE NETWORK
LT	2	LAMPADA SEGNALAZIONE BLOCCO TERMICO MOTORE VENTILATORE	INDICATOR LIGHT FOR FAN MOTOR OVERLOAD THERMAL CUTOUT

Data	25/05/2015	PREC.	FOGLIO
Revisione	00	10	11
Dis. N.	09 - 0430	SEGUE	TOTALE
		12	13

Sigla/Item	Foglio/Sheet	Funzione	Function
LTA	3	LAMPADA SEGNALAZIONE TRASFORMATORE DI ACCENSIONE	IGNITION TRANSFORMER INDICATOR LIGHT
LTP	2	LAMPADA SEGNALAZIONE BLOCCO TERMICO MOTORE VENTILATORE	INDICATOR LIGHT FOR FAN MOTOR OVERLOAD THERMAL CUTOUT
MB-DLE..Sx2	5	GRUPPO VALVOLE GAS	GAS VALVES GROUP
MBC..SEx2	5	GRUPPO VALVOLE GAS (ALTERNATIVO)	GAS VALVES GROUP (ALTERNATIVE)
MP	1	MOTORE POMPA GASOLIO	LIGHT OIL PUMP MOTOR
MV	1	MOTORE VENTILATORE	FAN MOTOR
PA	2	PRESSOSTATO ARIA	AIR PRESSURE SWITCH
PGCP_MIX	4	PRESSOSTATO GAS CONTROLLO PERDITE	GAS LEAKAGE PRESSURE SWITCH
PGMAX	6	PRESSOSTATO GAS DI MASSIMA PRESSIONE (OPTIONAL)	MAXIMUM PRESSURE GAS SWITCH (OPTIONAL)
PGMIN	3	PRESSOSTATO GAS DI MINIMA PRESSIONE	MINIMUM GAS PRESSURE SWITCH
POMAX	4	PRESSOSTATO DI MASSIMA PRESSIONE OLIO (OPTIONAL)	MAXIMUM OIL PRESSURE SWITCH (OPTIONAL)
PT100	8	SONDA DI TEMPERATURA	TEMPERATURE PROBE
RWF50.2x	7	REGOLATORE MODULANTE	BURNER MODULATOR
RWF55.5x	7	REGOLATORE MODULANTE (ALTERNATIVO)	BURNER MODULATOR (ALTERNATIVE)
SD-PRESS	8	SONDA DI PRESSIONE	PRESSURE PROBE
SD-TEMP.	8	SONDA DI TEMPERATURA	TEMPERATURE PROBE
SD - 0÷10V	8	TRASDUTTORE USCITA IN TENSIONE	TRANSDUCER VOLTAGE OUTPUT
SD - 4÷20mA	8	TRASDUTTORE USCITA IN CORRENTE	TRANSDUCER CURRENT OUTPUT
SQN1../SQM3.. AIR	6	SERVOCOMANDO SERRANDA ARIA	AIR DAMPER ACTUATOR
SQN1../SQM3.. FUEL	6	SERVOCOMANDO COMBUSTIBILE	FUEL ACTUATOR
ST	4	SERIE TERMOSTATI/PRESSOSTATI	SERIES OF THERMOSTATS OR PRESSURE SWITCHES
TA	3	TRASFORMATORE DI ACCENSIONE	IGNITION TRANSFORMER
TAB	4	TERMOSTATO/PRESSOSTATO ALTA-BASSA FIAMMA	HIGH-LOW THERMOSTAT/PRESSURE SWITCHES
TC	8	TERMOCOPPIA	THERMOCOUPLE
TP	1	TERMICO MOTORE POMPA	PUMP MOTOR THERMAL
TV	1	TERMICO MOTORE VENTILATORE	FAN MOTOR THERMAL
UV	6	SONDA UV RILEVAZIONE FIAMMA	UV FLAME DETECTOR

Data	25/05/2015	PREC.	FOGLIO
Revisione	00	11	12
Dis. N.	09 - 0430	SEGUE	TOTALE
		13	13

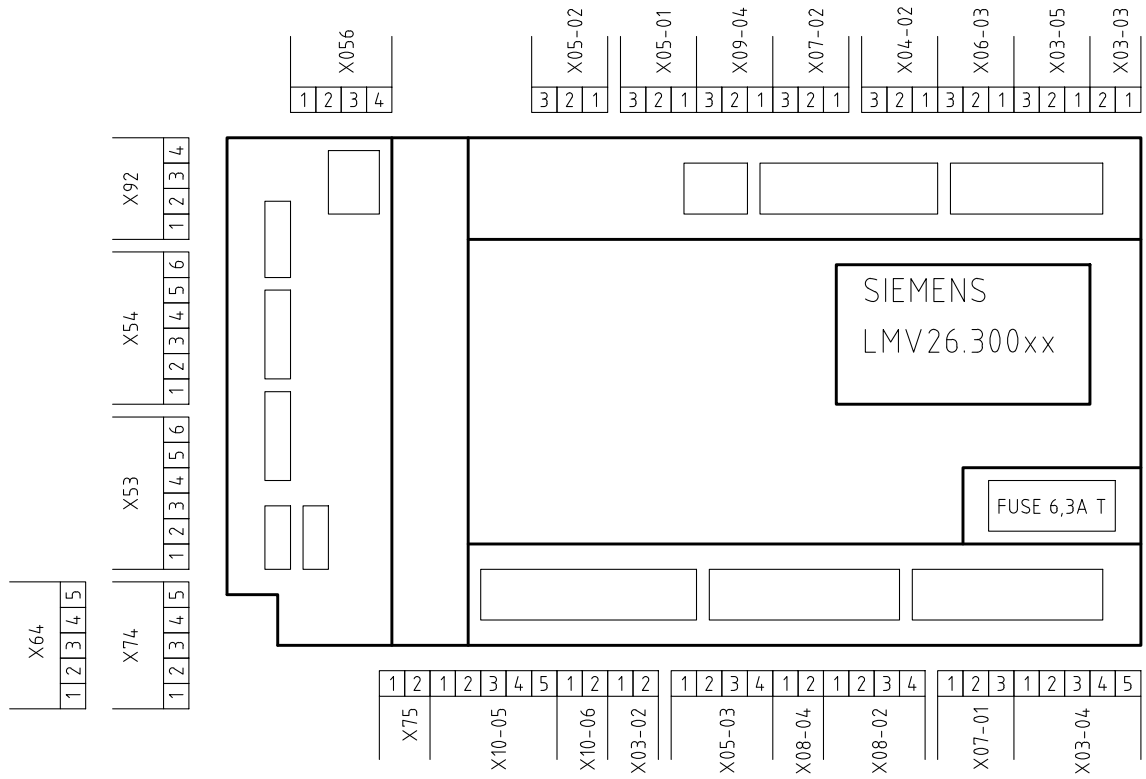

VISTA LATO COMPONENTI

COMPONENTS SIDE VIEW

CKMP

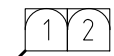

BIANCO WHITE

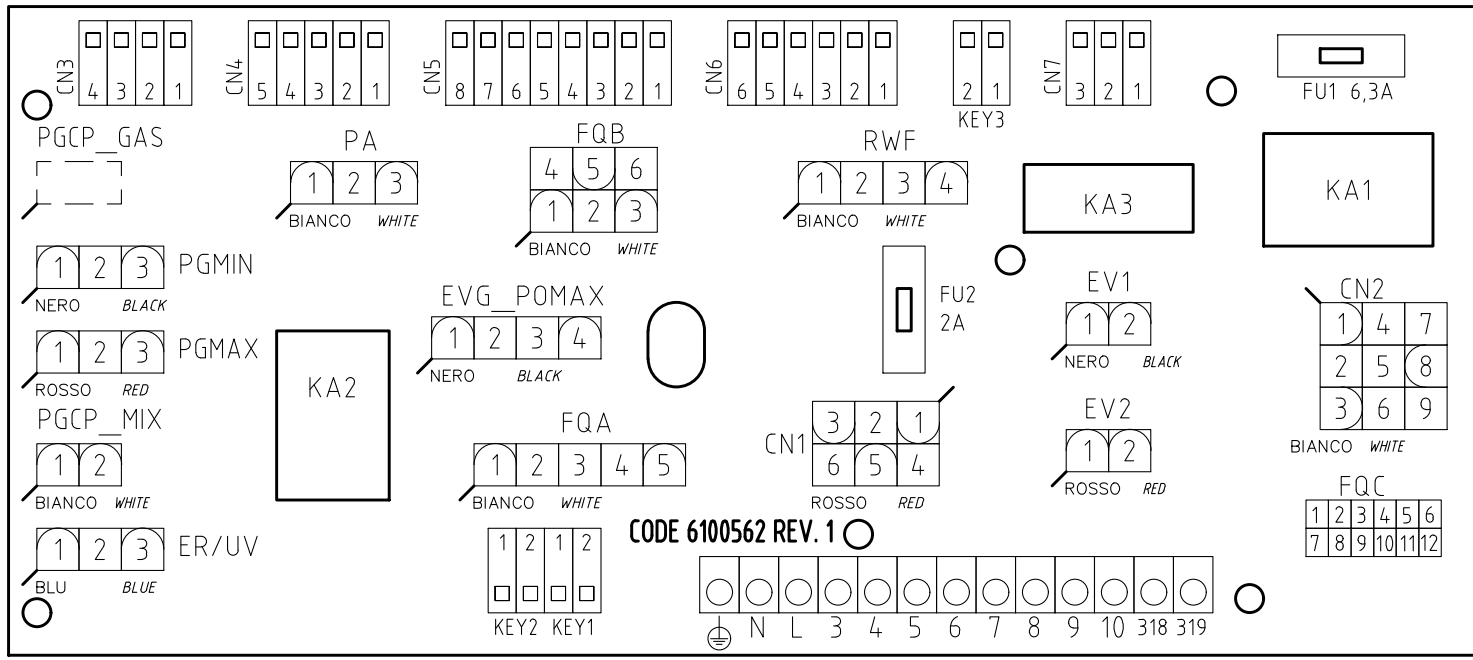

CODE 6100562 REV. 1

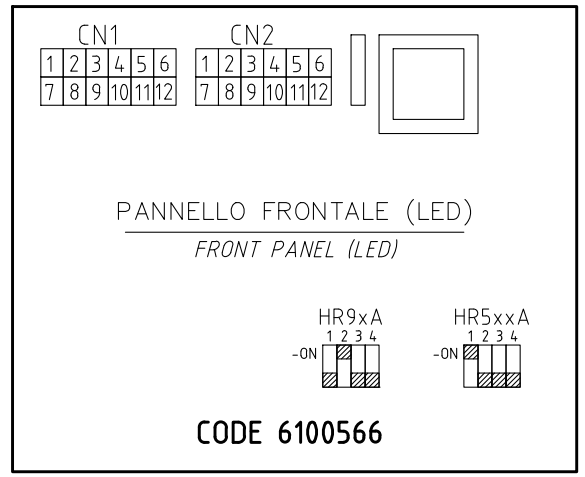
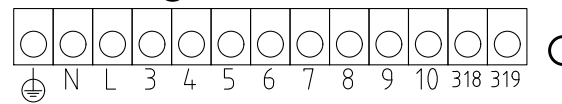

PANNELLO FRONTALE (LED)

FRONT PANEL (LED)

CODE 6100566

Data	25/05/2015	PREC.	FOGLIO
Revisione	00	12	13
Dis. N.	09 - 0430	SEGUE	TOTALE
		/	13