

02	AGGIUNTO/ADDED "RWF55.xx" & "KM3"	30/06/15	U. PINTON
01	AGGIUNTO/ADDED "RWF50.2x" & "600V"	17/10/12	U. PINTON
REV.	MODIFICA	DATA	FIRME



Impianto
 TIPI/TYPES NG(X) 280/350/400/550 LG280/350/400/550
 MODELLO/MODEL x-.MD.x.xx.Y.x.xx

Descrizione
 VERSIONE CON LMV20 + RWF.. / 600V / KM3
 WITH LMV20 + RWF.. / 600V / KM3 VERSION

Ordine	
Commessa	Data Controllato 30/06/2015
Esecutore U. PINTON	Controllato G. SCATTOLIN

Data	15/10/2008
Revisione	02
Dis. N.	04 - 0753

PREC.	FOGLIO
/	1
SEGUE	TOTALE
2	10

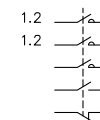
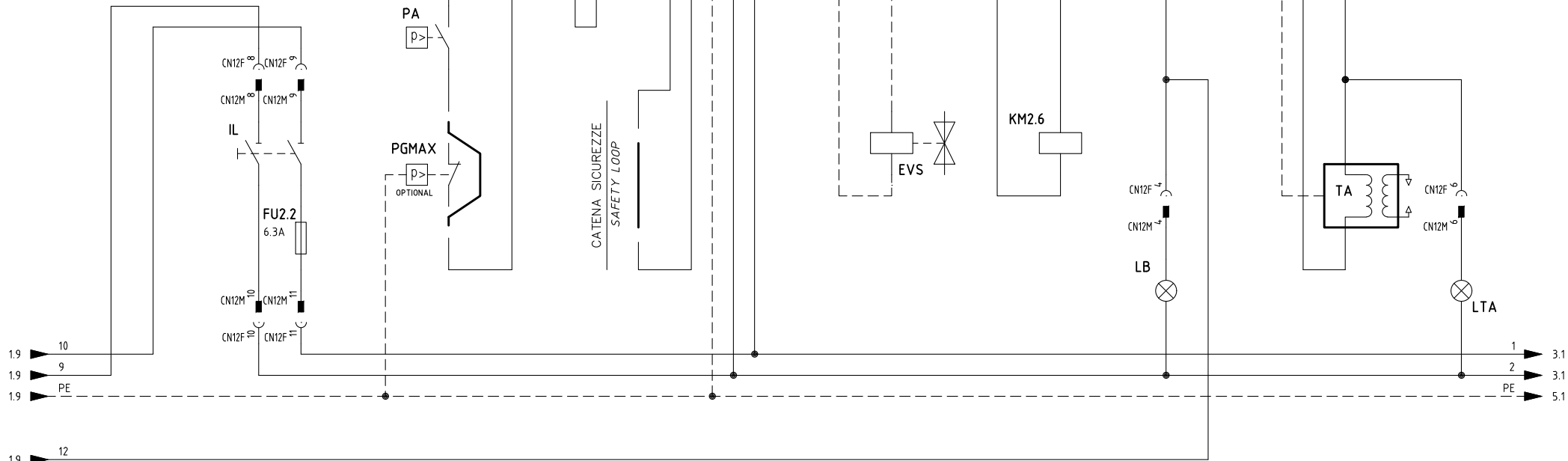
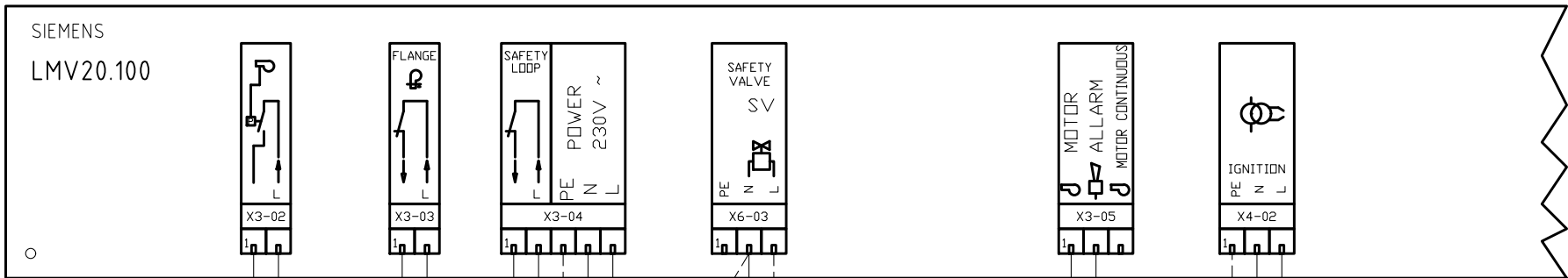

Data	15/10/2008	PREC.	FOGLIO
Revisione	02	1	2
Dis. N.	04 - 0753	SEGUE	TOTALE
		3	10

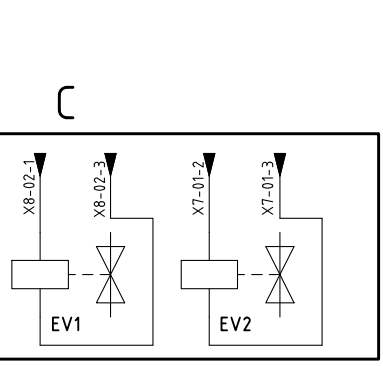
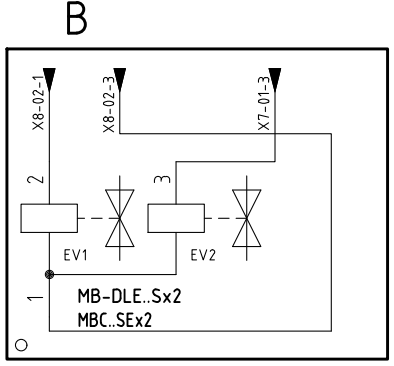
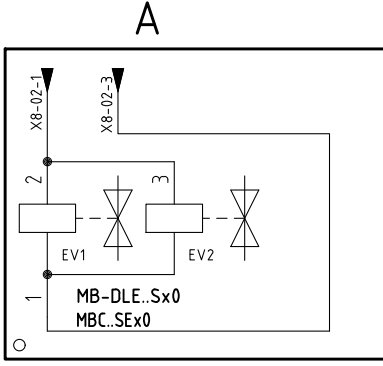
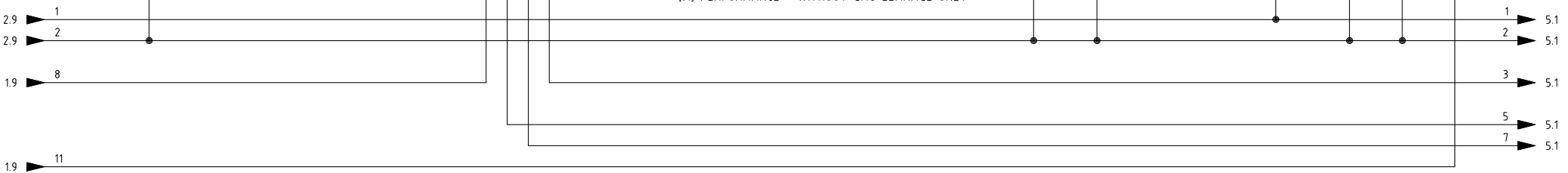
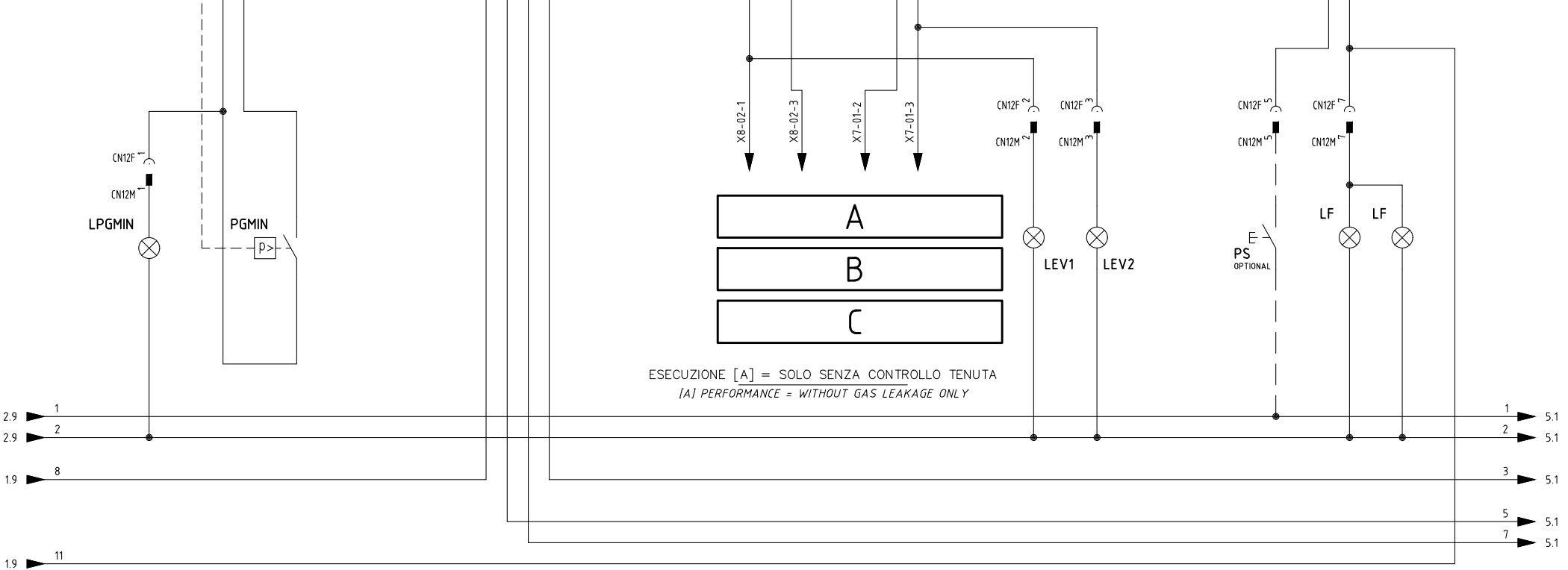
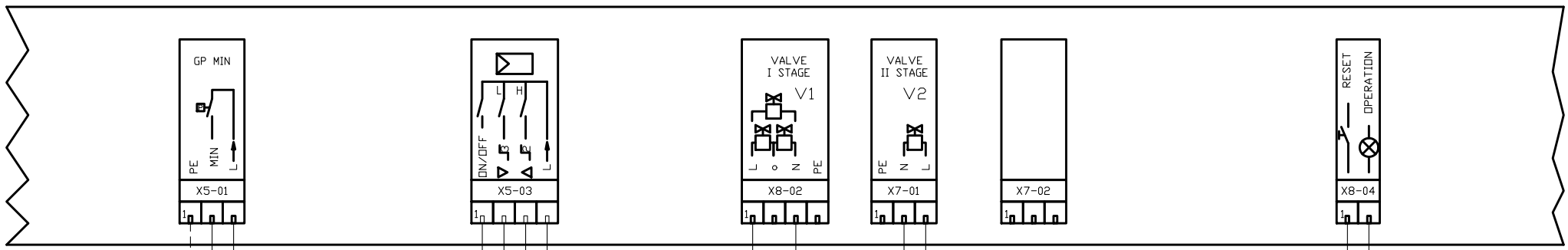

Data	15/10/2008	PREC.	FOGLIO
Revisione	02	2	3
Dis. N.	04 - 0753	SEGUE	TOTALE
		4	10

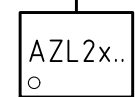
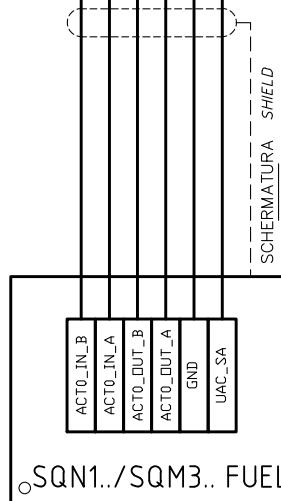
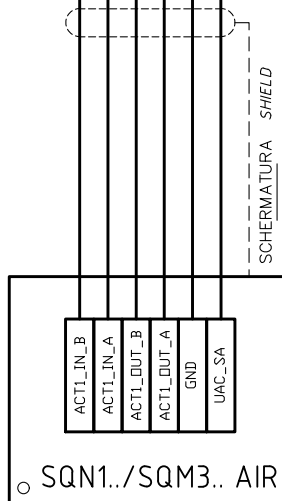
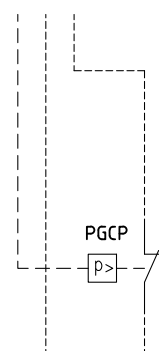
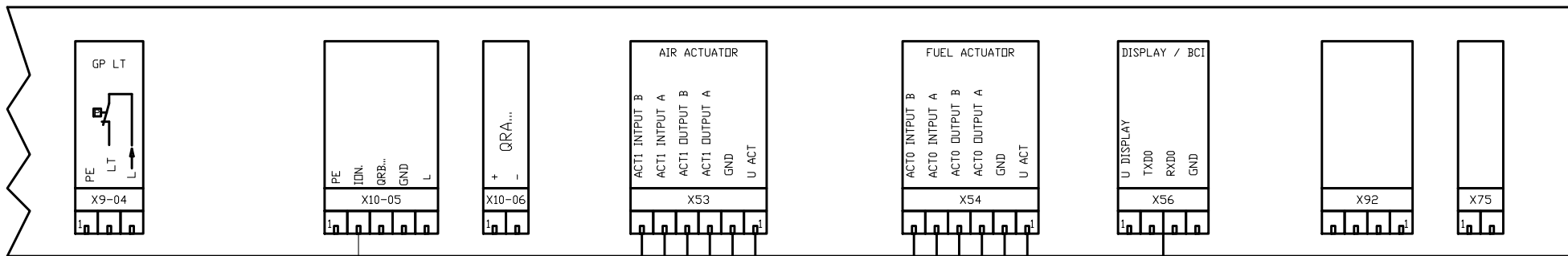

NON USATO PER VERSIONI SENZA CONTROLLO TENUTA
 NOT USED FOR VERSION WITHOUT GAS LEAKAGE

Data	15/10/2008	PREC.	FOGLIO
Revisione	02	3	4
Dis. N.	04 - 0753	SEGUE	TOTALE
		5	10

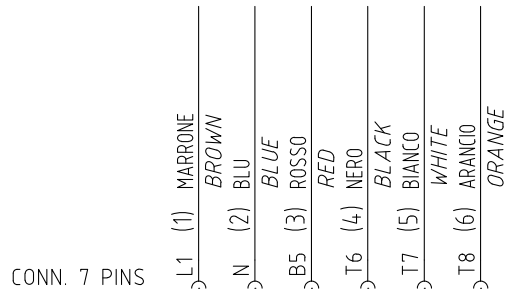
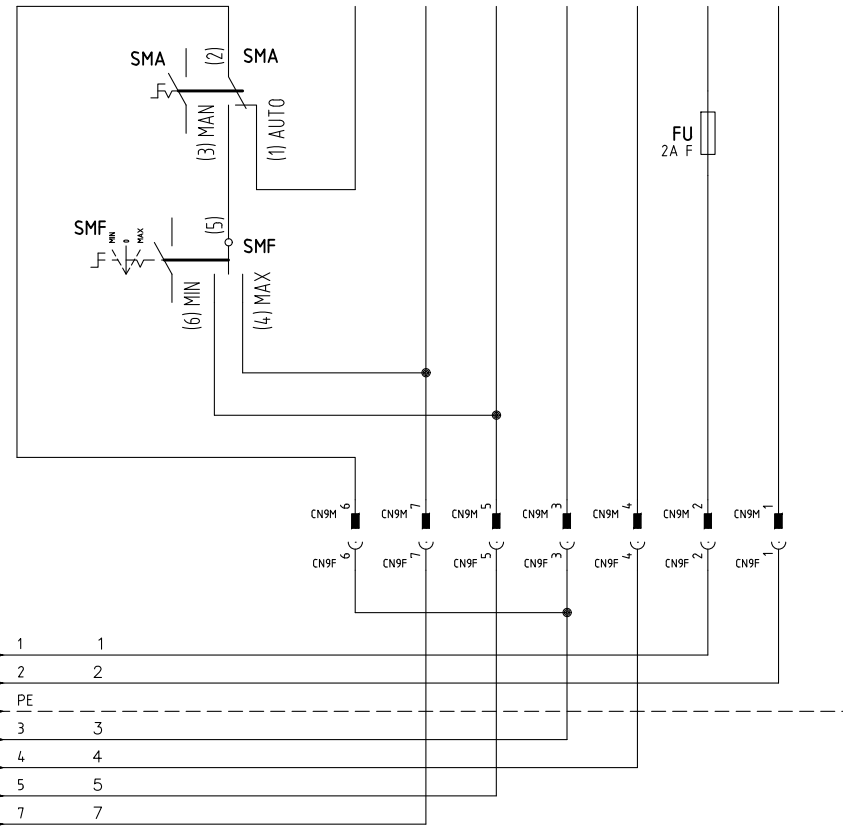
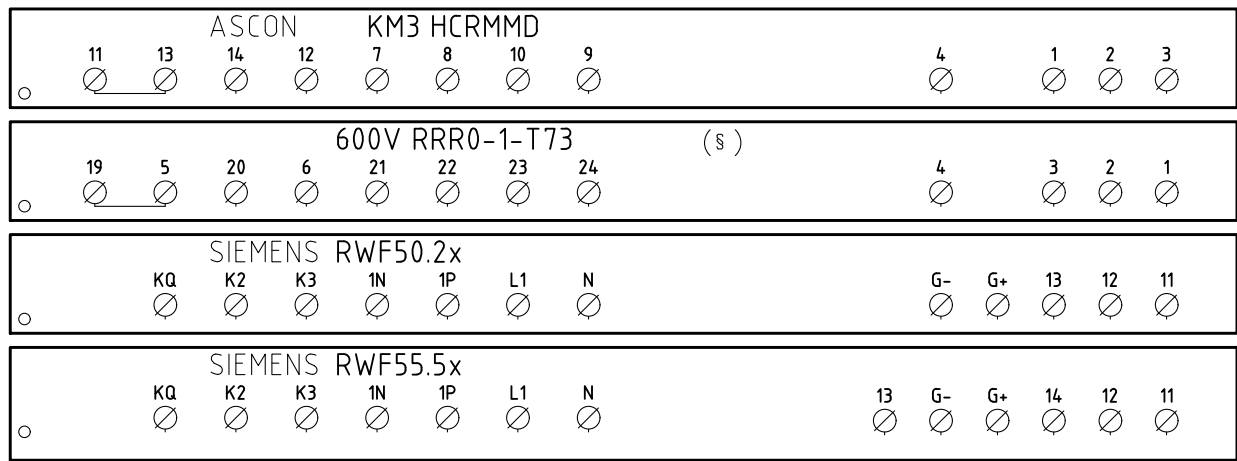

CAVO 7x0,75mmq
7x0,75mmq CABLE

(xx)
ATTENZIONE COLLEGAMENTO SONDE CON CONNETTORE 7 POLI
WARNING PROBE CONNECTION WITH 7 PINS CONNECTOR

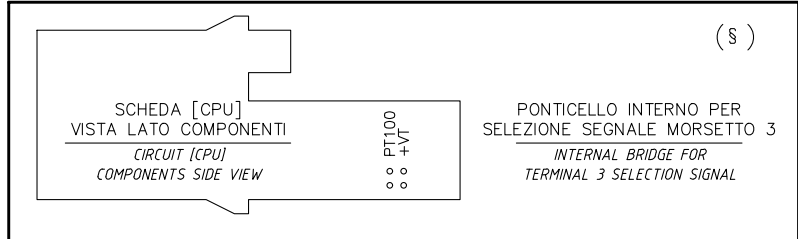

VERSIONE (PR) / VERSIONE (MD) CON RWF.. / 600V / KM3
(PR) VERSION / (MD) VERSION WITH RWF.. / 600V / KM3

Data	15/10/2008	PREC.	FOGLIO
Revisione	02	4	5
Dis. N.	04 - 0753	SEGUE	TOTALE
		6	10

(xx)

ATTENZIONE COLLEGAMENTO SONDE CON CONNETTORE 7 POLI
 WARNING PROBE CONNECTION WITH 7 PINS CONNECTOR

KM3 HCRMMD

600V RRR0-1-T73

RWF55.5x

RWF50.2x

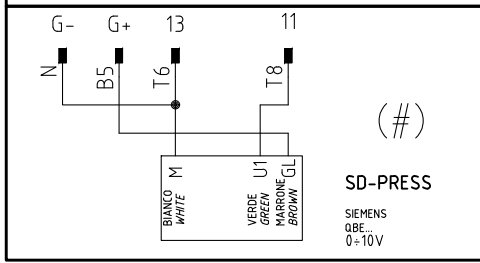
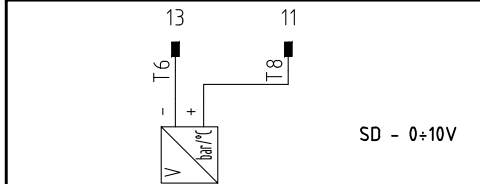
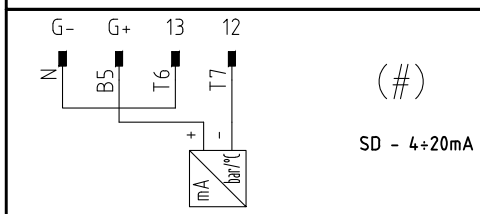
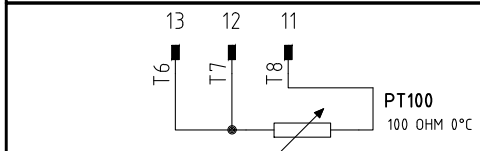
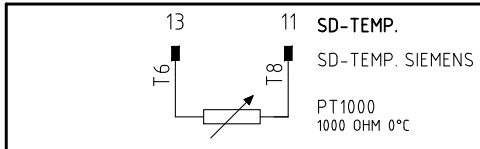
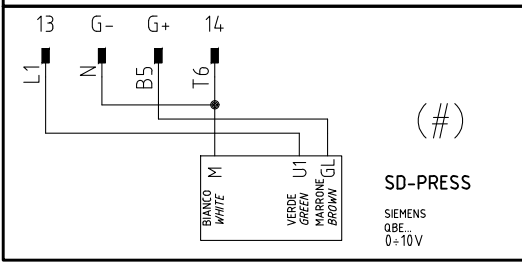
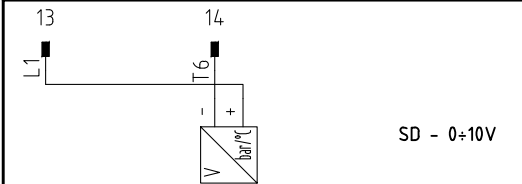
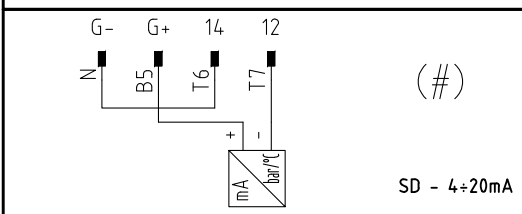
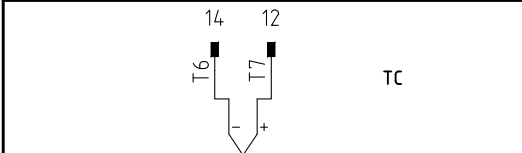
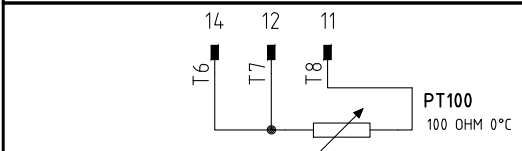
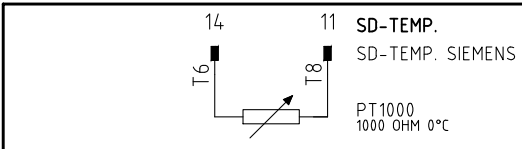
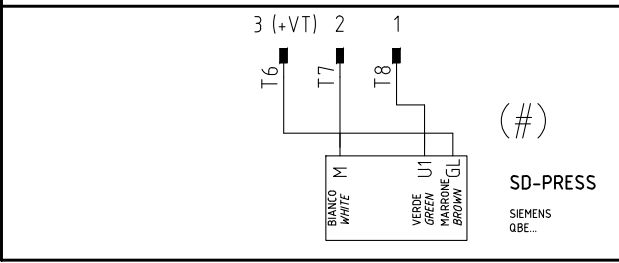
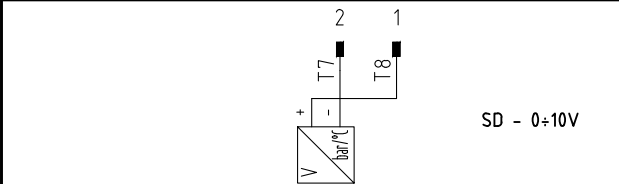
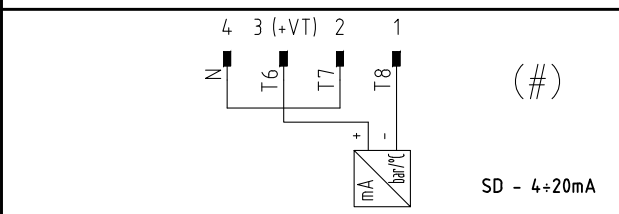
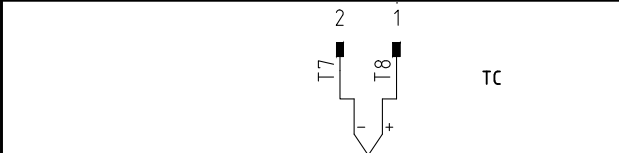
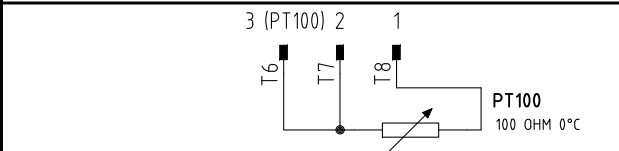
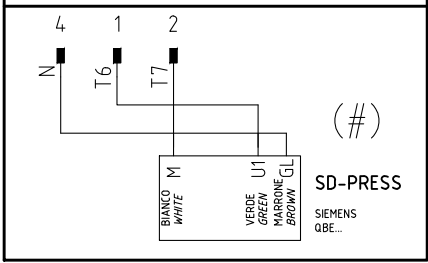
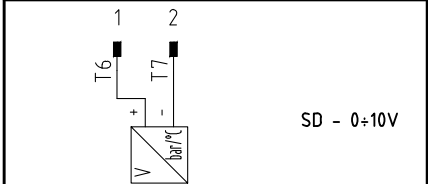
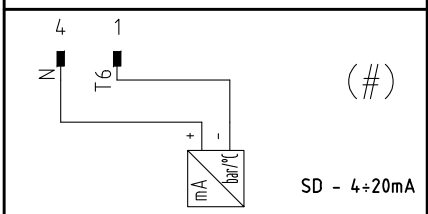
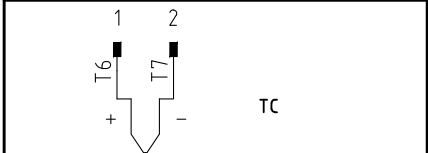
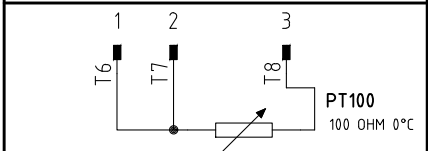
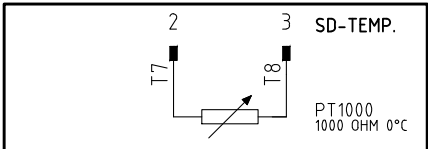

(#)

COLLEGAMENTO SOLO PER TRASDUTTORI PASSIVI
 TRANSDUCER PASSIVE CONNECTION ONLY

Data	15/10/2008	PREC.	FOGLIO
Revisione	02	5	6
Dis. N.	04 - 0753	SEGUE	TOTALE
		7	10

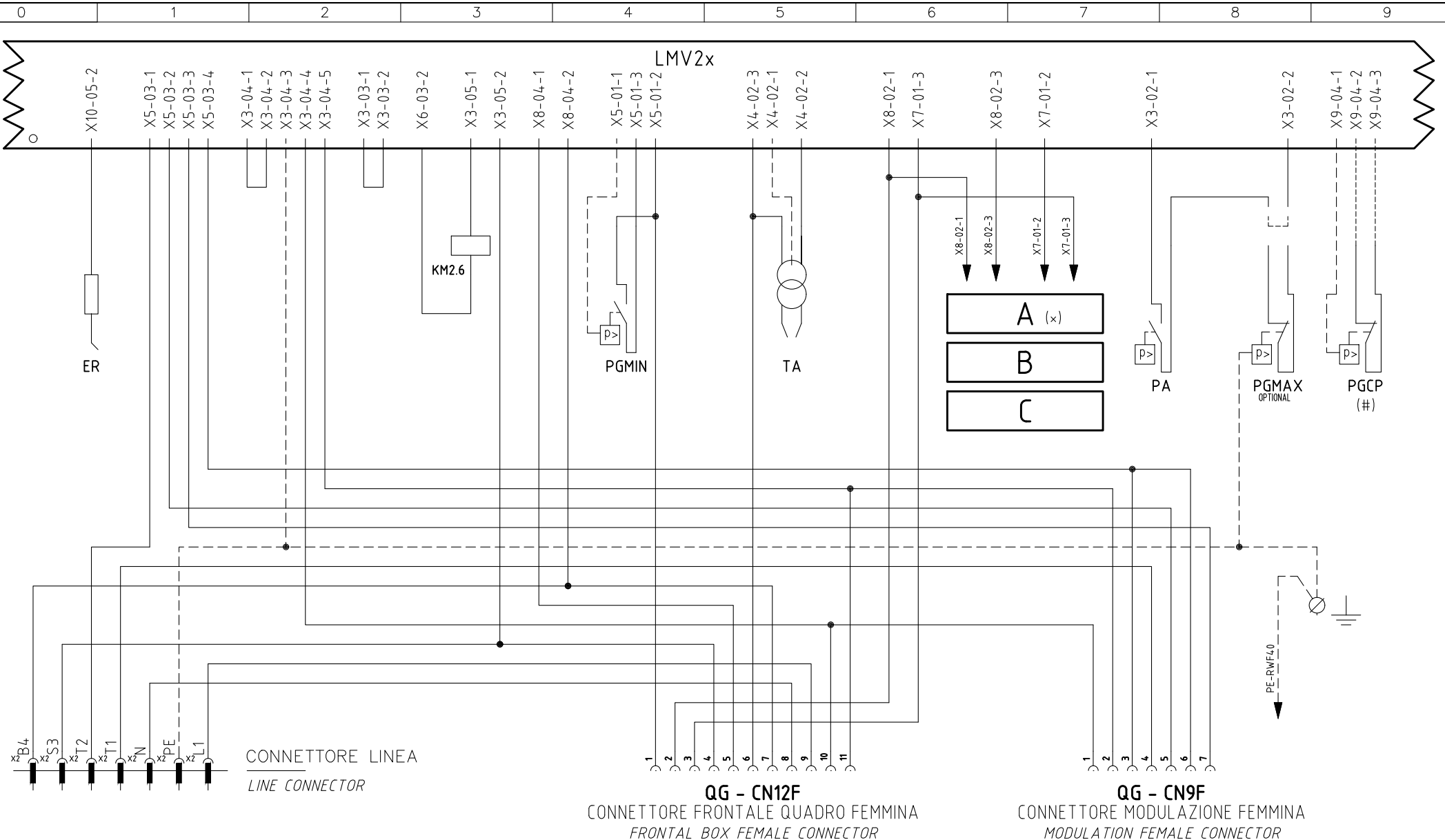

(#)
 NON USATO PER VERSIONI SENZA CONTROLLO TENUTA
 NOT USED FOR VERSION WITHOUT GAS LEAKAGE

(x)
 ESECUZIONE [A] = SOLO SENZA CONTROLLO TENUTA
 [A] PERFORMANCE = WITHOUT GAS LEAKAGE ONLY

INTERFACCIA CONNETTORI [LMV2x]
 CONNECTORS [LMV2x] INTERFACE

Data	15/10/2008	PREC.	FOGLIO
Revisione	02	6	7
Dis. N.	04 - 0753	SEGUE	TOTALE
		8	10

QG - CN12M

CONNETTORE FRONTALE QUADRO MASCHIO
FRONTAL BOX MALE CONNECTOR

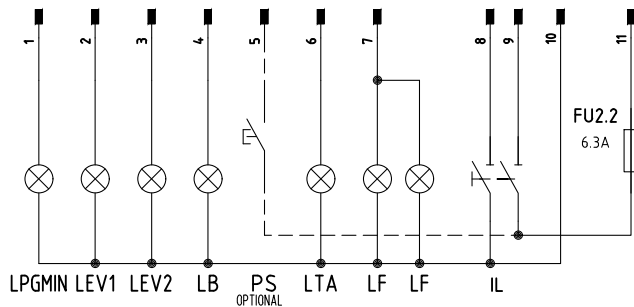

QG - CN9M

CONNETTORE MODULAZIONE MASCHIO
MODULATION MALE CONNECTOR

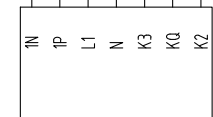
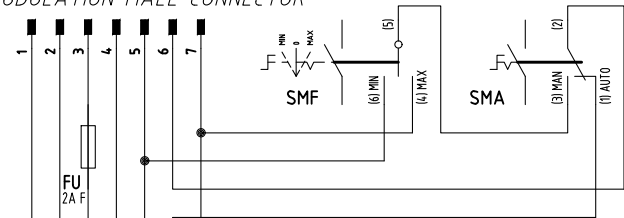

RWF50.2x - RWF55.5x

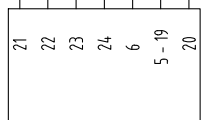

600V RRR0-1-T73

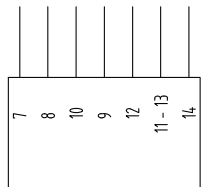

KM3 HCRMMD

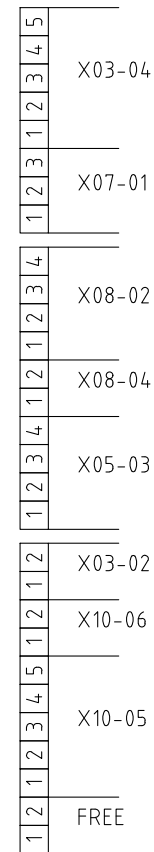
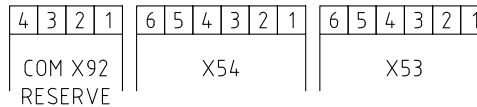
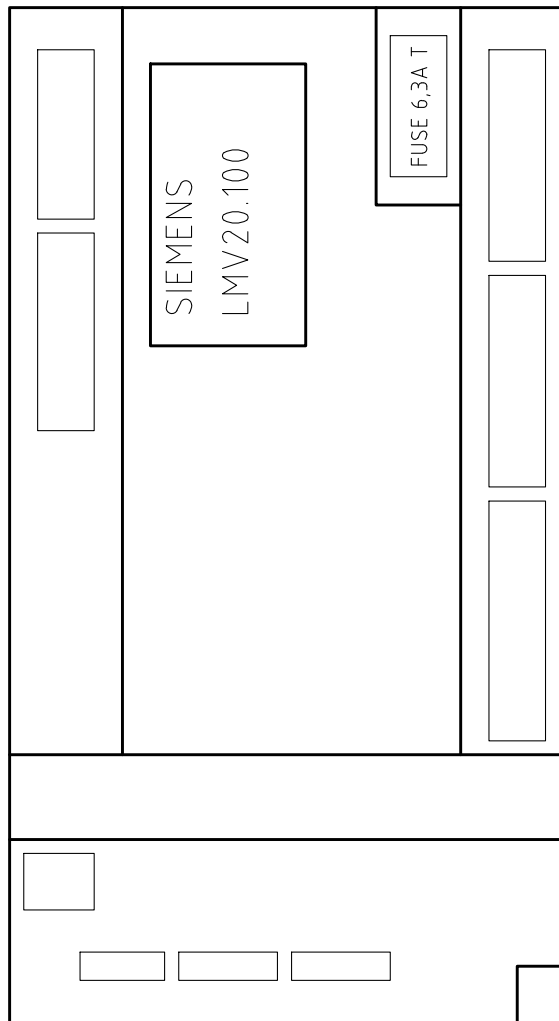
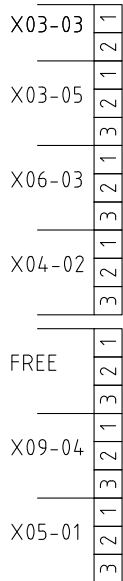

Data	15/10/2008	PREC.	FOGLIO
Revisione	02	7	8
Dis. N.	04 - 0753	SEGUE	TOTALE
		9	10

Sigla/Item	Foglio/Sheet	Funzione	Function
600V RRR0-1-T73	5	REGOLATORE MODULANTE (ALTERNATIVO)	BURNER MODULATOR (ALTERNATIVE)
AZL2x..	4	INTERFACCIA UTENTE	USER INTERFACE
C1	1	CONTAORE FUNZIONAMENTO	OPERATION TIME COUNTER
ER	4	ELETTRODO RILEVAZIONE FIAMMA	FLAME DETECTION ELECTRODE
EV1	3	ELETTROVALVOLA GAS LATO RETE	UPSTREAM GAS SOLENOID VALVE
EV2	3	ELETTROVALVOLA GAS LATO BRUCIATORE	DOWNSTREAM GAS SOLENOID VALVE
EVS	2	ELETTROVALVOLA GAS DI SICUREZZA (OPTIONAL)	SAFETY GAS SOLENOID VALVE (OPTIONAL)
FU	5	FUSIBILE	FUSE
FU1	1	FUSIBILE LINEA MOTORE VENTILATORE	FAN MOTOR LINE FUSE
FU2.2	2	FUSIBILE LINEA AUSILIARI	AUXILIARY LINE FUSE
FU3	1	FUSIBILE LINEA BRUCIATORE	BURNER LINE FUSE
IB	1	INTERRUTTORE LINEA BRUCIATORE	BURNER LINE SWITCH
IL	2	INTERRUTTORE LINEA AUSILIARI	AUXILIARY LINE SWITCH
IM	1	INTERRUTTORE LINEA MOTORE VENTILATORE	FAN MOTOR LINE SWITCH
KM2.6	2	CONTATTORE MOTORE VENTILATORE	FAN MOTOR CONTACTOR
KM3 HCRMD	5	REGOLATORE MODULANTE (ALTERNATIVO)	BURNER MODULATOR (ALTERNATIVE)
LB	2	LAMPADA SEGNALAZIONE BLOCCO BRUCIATORE	INDICATOR LIGHT FOR BURNER LOCK-OUT
LB1	1	LAMPADA SEGNALAZIONE BLOCCO BRUCIATORE	INDICATOR LIGHT FOR BURNER LOCK-OUT
LBF	1	LAMPADA SEGNALAZIONE BASSA FIAMMA BRUCIATORE	BURNER IN LOW FLAME INDICATOR LIGHT
LEV1	3	LAMPADA SEGNALAZIONE APERTURA [EV1]	INDICATOR LIGHT FOR OPENING OF ELECTRO-VALVE [EV1]
LEV2	3	LAMPADA SEGNALAZIONE APERTURA [EV2]	INDICATOR LIGHT FOR OPENING OF ELECTRO-VALVE [EV2]
LF	3	LAMPADA SEGNALAZIONE FUNZIONAMENTO BRUCIATORE	INDICATOR LIGHT BURNER OPERATION
LF	3	LAMPADA SEGNALAZIONE FUNZIONAMENTO BRUCIATORE	INDICATOR LIGHT BURNER OPERATION
LMV20.100	2	APPARECCHIATURA DI COMANDO	CONTROL SCHEME
LPGMIN	3	LAMPADA SEGNALAZIONE PRESENZA GAS IN RETE	INDICATOR LIGHT FOR PRESENCE OF GAS IN THE NETWORK
LTA	2	LAMPADA SEGNALAZIONE TRASFORMATORE DI ACCENSIONE	IGNITION TRANSFORMER INDICATOR LIGHT
MB-DLE..Sx0	3	GRUPPO VALVOLE GAS	GAS VALVES GROUP
MB-DLE..Sx2	3	GRUPPO VALVOLE GAS	GAS VALVES GROUP
MBC..SEx0	3	GRUPPO VALVOLE GAS (ALTERNATIVO)	GAS VALVES GROUP (ALTERNATIVE)
MBC..SEx2	3	GRUPPO VALVOLE GAS (ALTERNATIVO)	GAS VALVES GROUP (ALTERNATIVE)
MV	1	MOTORE VENTILATORE	FAN MOTOR
PA	2	PRESSOSTATO ARIA	AIR PRESSURE SWITCH

Data	15/10/2008	PREC.	FOGLIO
Revisione	02	8	9
Dis. N.	04 - 0753	SEGUE	TOTALE
		10	10

Sigla/Item	Foglio/Sheet	Funzione	Function
PGCP	4	PRESSOSTATO GAS CONTROLLO PERDITE (OPTIONAL)	GAS LEAKAGE PRESSURE SWITCH (OPTIONAL)
PGMAX	2	PRESSOSTATO GAS DI MASSIMA PRESSIONE (OPTIONAL)	MAXIMUM PRESSURE GAS SWITCH (OPTIONAL)
PGMIN	3	PRESSOSTATO GAS DI MINIMA PRESSIONE	MINIMUM GAS PRESSURE SWITCH
PS	3	PULSANTE SBLOCCO BRUCIATORE	BURNER UNLOCK BUTTON
PT100	6	SONDA DI TEMPERATURA	TEMPERATURE PROBE
RWF50.2x	5	REGOLATORE MODULANTE	BURNER MODULATOR
RWF55.5x	5	REGOLATORE MODULANTE (ALTERNATIVO)	BURNER MODULATOR (ALTERNATIVE)
SD-PRESS	6	SONDA DI PRESSIONE	PRESSURE PROBE
SD-TEMP.	6	SONDA DI TEMPERATURA	TEMPERATURE PROBE
SD - 0÷10V	6	TRASDUTTORE USCITA IN TENSIONE	TRANSDUCER VOLTAGE OUTPUT
SD - 4÷20mA	6	TRASDUTTORE USCITA IN CORRENTE	TRANSDUCER CURRENT OUTPUT
SMA	5	SELETTORE MANUALE/AUTOMATICO	MANUAL/AUTOMATIC SWITCH
SMF	5	SELETTORE MANUALE FUNZIONAMENTO MIN-0-MAX	MIN-0-MAX MANUAL OPERATION SWITCH
SQN1../SQM3.. AIR	4	SERVOCOMANDO SERRANDA ARIA	AIR DAMPER ACTUATOR
SQN1../SQM3.. FUEL	4	SERVOCOMANDO COMBUSTIBILE	FUEL ACTUATOR
ST	1	SERIE TERMOSTATI/PRESSOSTATI	SERIES OF THERMOSTATS OR PRESSURE SWITCHES
TA	2	TRASFORMATORE DI ACCENSIONE	IGNITION TRANSFORMER
TC	6	TERMOCOPPIA	THERMOCOUPLE
TS	1	TERMOSTATO/PRESSOSTATO DI SICUREZZA	SAFETY THERMOSTAT OR PRESSURE SWITCH

Data	15/10/2008	PREC.	FOGLIO
Revisione	02	9	10
Dis. N.	04 - 0753	SEGUE	TOTALE
		/	10